

APPENDIX K-2

*Environmental Noise Impact Assessment of the
Proposed Orcem Development, Vallejo, California*

**ENVIRONMENTAL NOISE
IMPACT ASSESSMENT OF
THE PROPOSED ORCEM
DEVELOPMENT, VALLEJO,
CALIFORNIA**



The Tecpro Building,
Clonshaugh Business & Technology Park,
Dublin 17, Ireland.

T: + 353 1 847 4220
F: + 353 1 847 4257
E: info@awnconsulting.com
W: www.awnconsulting.com

ILLINGWORTH & RODKIN, INC.
Acoustics • Air Quality

Technical Report Prepared For

**Orcem
c/o Loewke Planning Associates
547 Wycombe Ct.
San Ramon
CA 94583**

Technical Report Prepared By

Dr Stephen Smyth BA BAI MIEI MIOA

Our Reference

SS/13/6740NR01

Date Of Issue

10 March 2014

Cork Office



Unit 5, ATS Building,
Carrigaline Industrial Estate,
Carrigaline, Co. Cork.
T: +353 21 438 7400
F: +353 21 483 4606

AWN Consulting Limited
Registered in Ireland No. 319812
Directors: F Callaghan, C Dilworth,
T Donnelly, E Porter
Associate Director: D Kelly

Document History

Document Reference		Original Issue Date	
SS/13/6740NR01		10 March 2014	
Revision Level	Revision Date	Description	Sections Affected

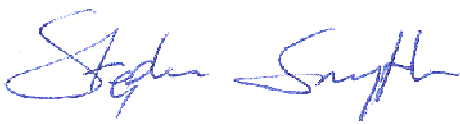
Record of Approval

Details	Written by	Approved by
Signature		
Name	Dr Stephen Smyth	Damian Kelly
Title	Senior Acoustic Consultant	Principal Acoustic Consultant
Date	10 March 2014	10 March 2014

EXECUTIVE SUMMARY

AWN Consulting Limited (AWN) and Illingworth & Rodkin (I&R) have been commissioned by Orcem to conduct an environmental noise and vibration impact assessment of its planned manufacturing facility at the former General Mills site, Vallejo, California. The General Mills facility is currently not in operation and it is proposed to redevelop the land to locate a Ground Granulated Blastfurnace Slag (GGBS) manufacturing facility on the site.

This document presents the results and conclusions of the noise impact assessment of the Orcem development.

Baseline environmental noise surveys, during day and night-time periods, have been carried out at noise sensitive locations beyond the boundaries of the proposed facility. The purpose of the surveys was to establish the existing noise climate in the vicinity of the site. It was found that the dominant noise sources in the area were local and distant road traffic with occasional activity on the Napa River also noted.

The construction phase of the project has been assessed using the calculation methodology detailed in the *Roadway Construction Noise Model* (RCNM) developed by the Federal Highway Administration (FHWA). It has been found that the construction activity has the potential to generate a substantial temporary increase in ambient noise levels in the vicinity of the project. However, implementation of the following multi-part mitigation measures would reduce potential construction period noise impacts:

- All construction equipment must have appropriate sound muffling devices, which shall be properly maintained and used at all times such equipment is in operation.
- Where feasible, the project contractor shall place all stationary construction equipment so that emitted noise is directed away from sensitive receptors nearest the project site.
- The construction contractor shall locate on-site equipment staging areas so as to maximize the distance between construction-related noise sources and noise-sensitive receptors nearest the project site.
- Except as otherwise permitted, construction activities shall be restricted to the hours of 7:00 a.m. to 9:00 p.m. daily.

Construction vibration is not expected to generate any significant impact due to the distance between the construction activities and the nearest sensitive properties.

The results of the operational phase assessment have found that there is a potentially significant and permanent noise increase at some properties as a result of the Orcem facilities fixed plant operation. In order to reduce the noise impact of the plant operation a series of mitigation measures have been proposed to specific items of plant. With these measures in place the noise impact of the regular operation of the Orcem plant is not significant. In addition, to the normal operation of the plant the additional noise impact of the temporary and infrequent ship unloading and rail loading activities have also been assessed. It has been found that neither of these operations will generate an additional noise impact that is classified as significant and therefore no specific mitigation measures are required for these activities.

No source of vibration is expected during the operational phase.

In conclusion, with appropriate noise mitigation measures the proposed Orcem facility can operate without generating a significant and permanent noise impact on the surrounding environment.

CONTENTS		Page
	Executive Summary	3
1.0	Introduction	5
2.0	Project Team	6
2.1	Company Profiles	6
2.2	Project Personnel	6
3.0	Fundamentals of Noise & Vibration	8
3.1	Noise	8
3.2	Vibration	9
4.0	Review of Relevant Guidance	10
4.1	Federal Guidance	10
4.2	State of California	10
4.3	City of Vallejo	11
4.4	State CEQA Guidelines	13
5.0	Noise Survey Details and Measured Noise Levels	14
5.1	Choice of Measurement Locations	14
5.2	Survey Periods	15
5.3	Procedure	15
5.4	Measurement Parameters	16
5.5	Results	16
5.6	Discussion of Results	17
6.0	Noise Sensitive Locations	18
7.0	Construction Phase Assessment	19
7.1	Construction Noise	19
7.2	Construction Vibration	22
8.0	Operational Phase Assessment	23
8.1	Orcem Activities	23
8.2	Fixed Plant Noise Emissions	23
8.3	Ship Unloading	27
8.4	Truck Movements on Local Road Network	29
8.5	Rail Activity	30
8.6	Overall Orcem Noise Impact	34
8.7	Operational Vibration	46
8.0	Conclusion	46
	Appendix A – Glossary of Acoustic Terminology	48
	Appendix B – Baseline Noise Report	49
	Appendix C – Meteorological Data During Noise Survey	104
	Appendix D – Construction Noise Calculation Sheets	129
	Appendix E – Orcem Mechanical Plant Data Sheets	141
	Appendix F – Equipment Drawings	183
	Appendix G – Strouhal Number Correction for Stack Noise Emissions	192
	Appendix H – Noise Model Details	194
	Appendix I – Plant Noise Model Results	199
	Appendix J – Noise Model Details	204

1.0 INTRODUCTION

This report addresses the potential noise and vibration impacts of the proposed Orcem manufacturing facility development at the site of the former General Mills facility, Vallejo, California. The General Mills facility is no longer in operation and it is proposed to redevelop the land to locate a Ground Granulated Blastfurnace Slag (GGBS) manufacturing facility on the site.

This report covers the noise and vibration impact on the local environment of the proposed development.

The site in question is illustrated in Figure 1 below. The site is located adjacent to the Napa River and is bounded to the east by a steep incline with thick vegetation, to the west by the Napa River, to the south by undeveloped land and Sandy Beach residential development beyond and to the North by other industrial lands.

The nearest residential noise sensitive locations to the site are located to the north-east within the condominiums on Seawitch Lane overlooking the site at a distance of approximately 295' from the nearest site boundary.

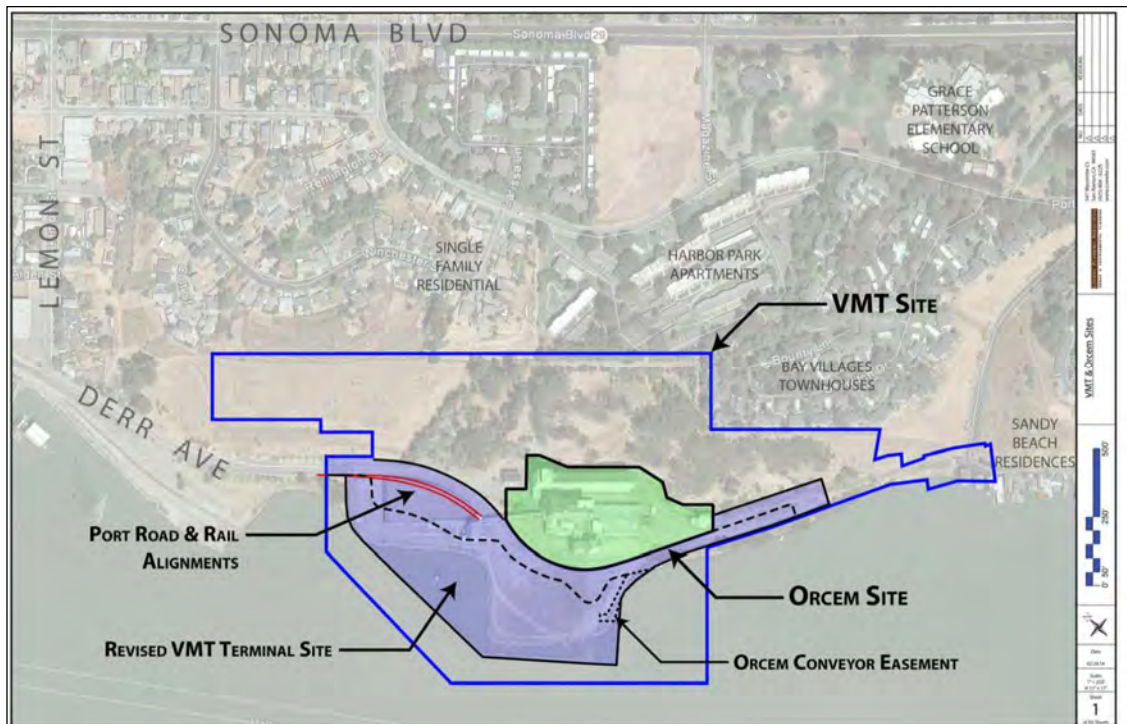

Figure 1 Site Location

As part of the overall development of the site there will be new noise sources introduced. These can broadly be described as follows:

- Vehicle movements on site;
- New fixed mechanical plant installations;
- Truck movements on the local road network;
- Ship unloading activity, and;
- Rail activity.

This report discusses the potential noise impact of these elements using the following methodology:

- Review of appropriate guidance in order to derive appropriate noise criteria for the proposed operations;
- Determination of the existing baseline noise environment through a series of baseline noise surveys;
- Assessment of the various stages of the proposed development through the development of a detailed 3D noise model of the site and adjoining noise sensitive locations, and;
- Discussion of possible mitigation measures (where required).

2.0 PROJECT TEAM

This report has been jointly prepared by AWN Consulting Ltd (AWN) and Illingworth & Rodkin Inc. (I&R). The following paragraphs provide a brief overview of both companies and also provide profiles of the key project team members.

2.1 Company Profiles

AWN

AWN Consulting is a multidisciplinary environmental consultancy specialising in Acoustics, Vibration, Air Quality and Water Quality. AWN Consulting is a wholly Irish owned company and has its Head Office in Dublin, Ireland. The staff of AWN Consulting represents Ireland's most experienced environmental and acoustic teams. AWN offers its clients a comprehensive package in respect of noise and vibration impact assessments using state of the art design and prediction tools. AWN's acoustics team comprises eight suitably qualified engineers with a total of over 100 man years spent working in the area, making it the largest and most experienced group of its type in Ireland, uniquely positioned to undertake a wide variety of projects.

I&R

I&R has provide a complete range of consulting services in acoustics, vibration and air quality to governmental agencies, private sector clients and other environmental and design professionals for over 27 years. I&R has completed over 4,500 projects in architectural acoustics, community noise and vibration, industrial noise and vibration control, hydroacoustics, tire/pavement noise research, and air quality studies.

2.2 Project Personnel

AWN

Eur Ing Chris Dilworth (Director) has responsibility for the Acoustics team in AWN Consulting. He is a European and Chartered Engineer with a BEng with First Class Honours in Electroacoustics from the Department of Applied Acoustics at the University of Salford. He is a corporate member of Engineers Ireland and the Institute of Acoustics with over twenty-five years' experience in the field of acoustics; he has been a consultant since 1989. Over that time he has specialized in building and architectural acoustics, having acted as acoustic consultant in respect of a large number of prestigious and landmark buildings. He has also been a contributor to official design guidance published by bodies such as the National Roads Authority,

British Aviation Authority, UK National Health Service and Environmental Protection Agency.

Damian Kelly (Principal Acoustic Consultant) holds a BSc from DCU and an MSc from QUB. He has some fourteen years of experience as an acoustic consultant. He is a Member of the Institute of Acoustics and a sitting member of the Irish committee. He has extensive knowledge in the field of architectural and environmental acoustics and in the area of industrial, wind farm and infrastructural noise modeling and prediction, having developed many of the largest and most complex examples of proprietary noise models prepared in Ireland to date in those fields.

Dr Stephen Smyth (Senior Acoustic Consultant) holds a BAI and a PhD in Mechanical Engineering from TCD and is a Member of Engineers Ireland and a Member of the Institute of Acoustics. He has experience in both environmental and building acoustics, and has prepared detailed noise models for a variety of industrial and commercial facilities. He is also experienced at public hearings having given expert evidence to numerous planning hearings over the course of his career.

I&R

James A. Reyff (Principal) is an air quality and acoustical specialist with I&R since October 1995. He is a meteorologist with a broad background in meteorology, air quality, and noise. His career in environmental studies began in 1989. Mr. Reyff has prepared both air quality and noise technical reports for Caltrans projects. Mr. Reyff combined his expertise in meteorology and transportation noise to manage a research study funded by Caltrans that investigated long-range diffraction and reflection of noise from sound walls under different meteorological conditions. He has a BA degree in Geoscience (Meteorology) from the San Francisco State University.

Michael S. Thill (Principal) has 15 years of professional experience with environmental acoustics. Mr. Thill's expertise lies in conducting field research, analyzing data, and noise modeling. He has conducted numerous field surveys in a variety of noise environments and has authored technical noise reports for residential projects, mixed-use projects, commercial projects, transportation projects, educational facilities, redevelopment projects, and office and industrial developments. Mr. Thill is proficient with use of FHWA's Traffic Noise Prediction Model (TNM), and is familiar with the procedures for preparing highway noise impact studies presented in Caltran's *Traffic Noise Analysis Protocol* and the *Technical Noise Supplement (TENS)*. Mr. Thill received a BS degree in Environmental Science from the University of California at Santa Barbara.

3.0 FUNDAMENTALS OF NOISE & VIBRATION

3.1 Noise

In order to provide a broader understanding of some of the technical discussion in this report, this section provides a brief overview of the fundamentals of acoustics and the basis for the preparation of this noise assessment. A sound wave travelling through the air is a regular disturbance of the atmospheric pressure. These pressure fluctuations are detected by the human ear, producing the sensation of hearing. In order to take account of the vast range of pressure levels that can be detected by the ear, it is convenient to measure sound in terms of a logarithmic ratio of sound pressures. These values are expressed as Sound Pressure Levels (SPL) in decibels (dB).

The audible range of sounds expressed in terms of Sound Pressure Levels is 0dB (for the threshold of hearing) to 120dB (for the threshold of pain). In general, a subjective impression of doubling of loudness corresponds to a tenfold increase in sound energy which conveniently equates to a 10dB increase in SPL. It should be noted that a doubling in sound energy (such as may be caused by a doubling of traffic flows) increases the SPL by 3dB, an increase that is just perceptible to the human ear.

The frequency of sound is the rate at which a sound wave oscillates, and is expressed in Hertz (Hz). The sensitivity of the human ear to different frequencies in the audible range is not uniform. For example, hearing sensitivity decreases markedly as frequency falls below 250Hz. In order to rank the SPL of various noise sources, the measured level has to be adjusted to give comparatively more weight to the frequencies that are readily detected by the human ear. Several weighting mechanisms have been proposed but the 'A-weighting' system has been found to provide one of the best correlations with perceived loudness. SPL's measured using 'A-weighting' are expressed in terms of dB(A). An indication of the level of some common sounds on the dB(A) scale is presented in Figure 2.

The 'A' subscript denotes that the sound levels have been A-weighted. The established prediction and measurement techniques for this parameter are well developed and widely applied.

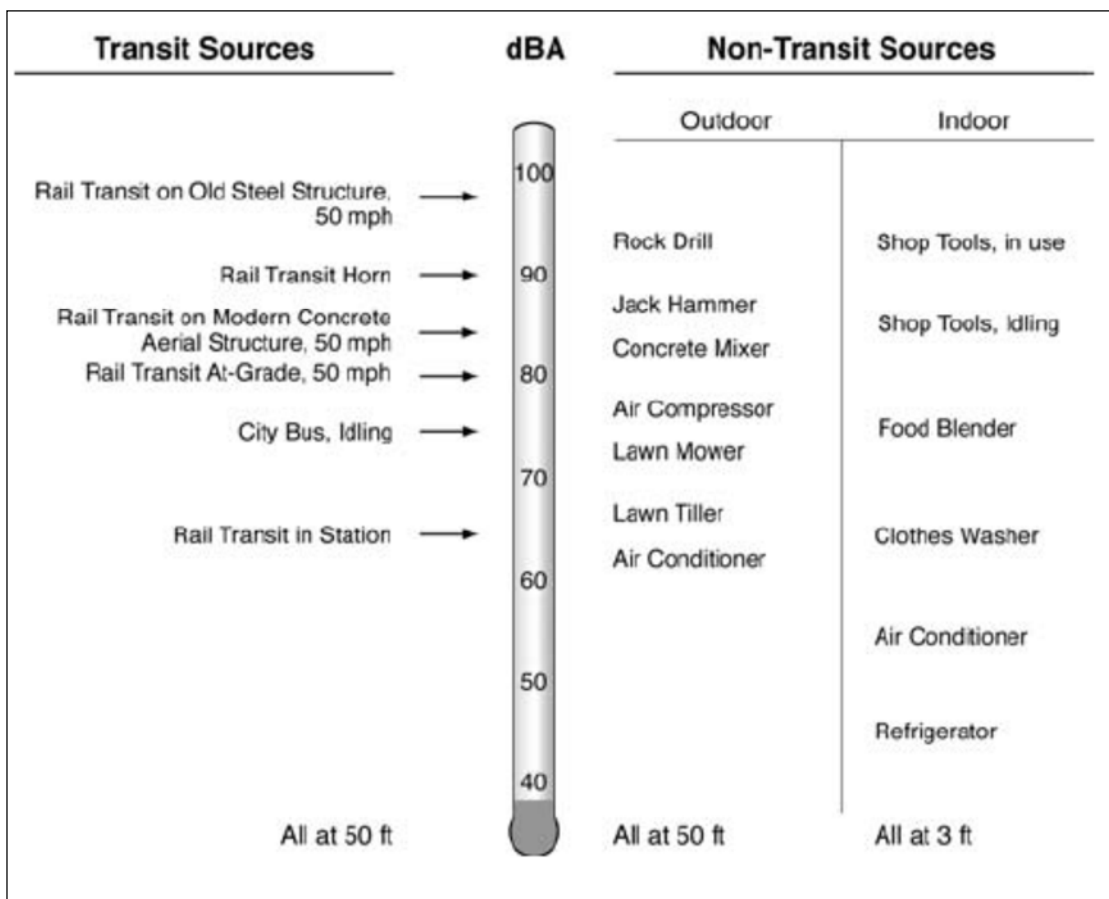

Figure 2 Level of Typical Common Sounds on the dB(A) Scale – (FTA Noise & Vibration Manual, 2006)

3.2 Vibration

Ground vibration consists of rapidly fluctuating motions or waves with an average motion of zero. Several methods are typically used to quantify the amplitude of vibration including Peak Particle Velocity (PPV) and Root Mean Square (RMS) velocity. PPV is defined as the maximum instantaneous positive or negative peak of the vibration wave. RMS velocity is defined as the average of the squared amplitude of the signal, usually measured in decibels referenced to 1micro-in/sec and reported in VdB. PPV and VdB vibration velocity amplitudes are used to evaluate human response to vibration.

Low-level vibrations frequently cause irritating secondary vibration, such as a slight rattling of windows, doors or stacked dishes. The rattling sound can give rise to exaggerated vibration complaints, even though there is very little risk of actual structural damage. In high noise environments, which are more prevalent where ground-borne vibration approaches perceptible levels, this rattling phenomenon may also be produced by loud airborne environmental noise causing induced vibration in exterior doors and windows.

In urban environments, sources of ground-borne vibration include construction activities, light and heavy rail transit, and heavy trucks and buses.

4.0 REVIEW OF RELEVANT GUIDANCE

The following section summarizes the regulatory framework related to noise, including federal, State and City of Vallejo requirements. Appendix A defines the noise parameters referenced throughout this report.

4.1 Federal Guidance

The U.S. Environmental Protection Agency (USEPA) is authorized under the Noise Control Act of 1972 to publish guidelines on the effects of noise and establish levels of noise which are “*requisite to protect the public welfare with an adequate margin of safety.*” Table 1 reproduces the levels published by the USEPA which have been separated into several categories.

Effect	Level	Area
Hearing Loss	$L_{eq(24)} \leq 70\text{dB}$	All areas.
Outdoor activity interference and annoyance	$L_{dn} \leq 55\text{dB}$	Outdoors in residential areas and farms and other outdoor areas where people spend widely varying amounts of time and other places in which quiet is a basis for use.
	$L_{eq(24)} \leq 55\text{dB}$	Outdoor areas where people spend limited amounts of time, such as school yards, playgrounds etc.
Indoor activity interference and annoyance	$L_{dn} \leq 45\text{dB}$	Indoor residential areas.
	$L_{eq(24)} \leq 45\text{dB}$	Other indoor areas with human activities such as schools, etc.

Table 1 USEPA Noise Guidelines

It is important to note that the USEPA does not identify these levels as limit values as they do not take into account the cost or feasibility of adopting the levels.

4.2 State of California

As of 1 January 2014 the State of California has adopted the 2013 California Building Code. Chapter 12 of this document provides guidance on the interior environment of buildings. The current iteration of this document no longer regulates sound transmission from exterior sources to the interior of buildings.

The previous iteration of this document adopted noise control regulations that apply to new hotels, motels, apartments and dwellings other than detached single family dwellings. The purpose of these guidelines was to limit the extent of noise transmitted into habitable spaces. These requirements were published in the California Code of Regulations 2010, Title 24, Part 2, Appendix Chapters 12 and 12A and specified that for limiting noise from external sources, the sound insulation performance of the building façade should be such that an interior noise standard of 45dB CNEL is achieved in any habitable room with all doors and windows closed.

In addition to the California Building Code the Governor's Office of Planning and Research (OPR) has published land use compatibility guidelines which specify acceptable noise levels for a variety of land uses. These guidelines have been adopted by the City of Vallejo and are discussed in the following section.

4.3 City of Vallejo

The noise policy of the City of Vallejo is addressed in the Noise Element of the General Plan and in the zoning chapter of the Municipal Code. As discussed in Section 4.2 the city has adopted the land use compatibility guidelines published by the OPR. The land use compatibility chart is reproduced in Figure 3 below.

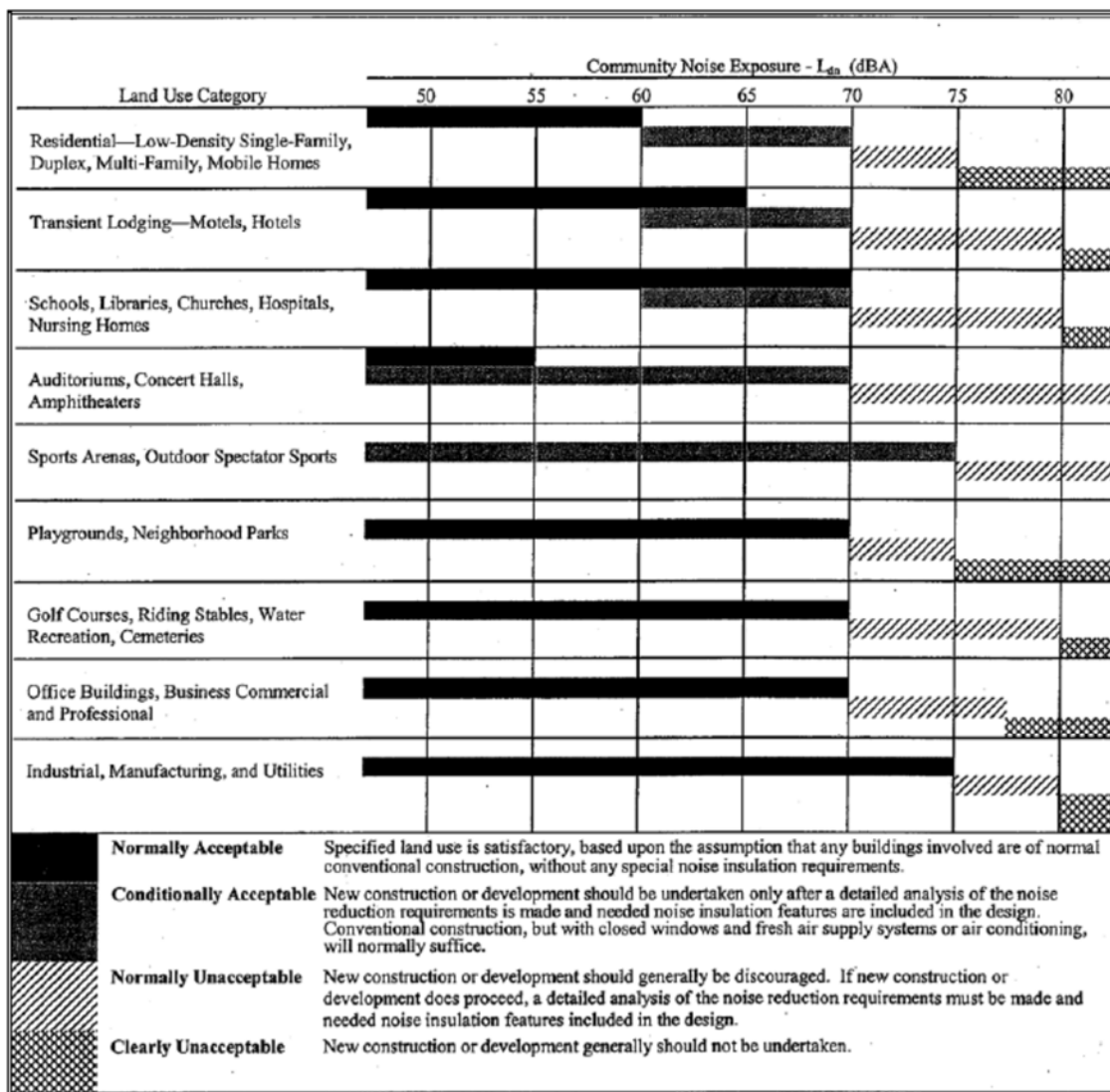

Figure 3 Land Use Compatibility Standards for Community Noise Environments

Referring to Figure 3 the normally acceptable noise level in low, medium and high density residential areas is 60dB L_{dn} . In areas zoned for business or commercial use the normally acceptable noise level is 70dB L_{dn} .

The General Plan specifies the City’s policy with respect to noise control in order to achieve the following stated goal:

“Maintain noise compatibility in a manner that is acceptable to residents and reasonable for commercial and industrial uses.”

In achieving this goal the General Plan specifies two policies as follows:

Policy 1 – Apply the noise guidelines shown in Figure 2 to land use decisions and other City actions.

- 1a. The exterior noise level at primary outdoor use areas for residences should not exceed the maximum “normally acceptable” level in Figure 2 (L_{dn} of 60dB for residences). Small decks and entry porches do not need to meet this goal. Noise levels up to 65dB L_{dn} may be allowed at the discretion of the City where it is not economically or aesthetically reasonable to meet the more restrictive outdoor goal.
- 1b. The interior noise standard shall be 45dB L_{dn} for all residential uses, including single and multi-family housing, hotels/motels and residential healthcare facilities.

Policy 2 – Avoid adverse effects of noise-producing activities on existing land uses by implementing noise reduction measures, limiting hours of operation or by limiting increases in noise.

- 2a. Continue to enforce the noise regulations within the Vallejo Municipal Code, including Chapter 7.84 “Regulation of Noise Disturbances” and Chapter 16.72 “Performance Standards Regulations”.
- 2b. Where appropriate, limit noise generating activities (for example construction and maintenance activities and loading and unloading activities) to the hours of 7:00am to 9:00pm.
- 2c. When approving new development limit project-related noise increases to no more than 10dB in non-residential areas and 5dB in residential areas where the with project noise level is less than the maximum “normally acceptable” level in Figure 2 (i.e. 60dB L_{dn} for residential areas up to 75dB L_{dn} for industrial or intensive use areas). Limit project related increases in all areas to no more than 3dB where the with project noise level exceeds the “normally acceptable” level.

The Noise Performance Standards Ordinance of the City of Vallejo’s Municipal Code specifies maximum sound pressure levels by zoning district. These maximum noise levels are reproduced in Table 2 below.

Zoning District	Maximum Sound Pressure Levels, dB
Resource Conservation, Rural Residential and Medical Districts	55
Low, Medium and High Density Residential Districts	60
Professional Offices, Neighbourhood, Pedestrian and Waterfront Shopping and Service Districts	70
Freeway Shopping and Service, Linear Commercial and Intensive Use Districts	75

Table 2 Noise Performance Standards

The city’s ordinance also allows for noise from temporary construction or demolition work, or sounds from transportation equipment used for the movement of goods or people to and from a given premises to exceed the maximum sound pressure levels listed in Table 2 once they comply with the State conditions.

4.4 State CEQA Guidelines

The California Environmental Quality Act (CEQA) contains guidelines to evaluate the significance of effects of environmental noise attributable to a proposed project. CEQA asks the following applicable questions. Would the project:

- a. Expose people to or generate noise levels in excess of standards established in the local general plan, noise ordinance, or applicable standards of other agencies;
- b. Expose people to or generate excessive groundborne vibration or groundborne noise levels;
- c. Result in a substantial permanent increase in ambient noise levels in the project vicinity above levels existing without the project;
- d. Result in a substantial temporary or periodic increase in ambient noise levels in the project vicinity above levels existing without the project;
- e. For projects within an area covered by an airport land use plan or within two miles of a public airport or public use airport when such an airport land use plan has not been adopted, or within the vicinity of a private airstrip, expose people residing or working in the project area to excessive aircraft noise levels;
- f. For a project within the vicinity of a private airstrip, expose people residing or working in the project area to excessive noise levels?

CEQA does not define the noise level increase that is considered substantial. However, following the guidance contained within the Vallejo General Plan the following definitions have been adopted:

Residential Areas

An increase in the day-night average noise level greater than 3 dB L_{dn} at noise-sensitive receptors would be considered significant when projected noise levels would exceed those considered satisfactory for the affected land use.

An increase greater than 5 dB L_{dn} would be considered significant when projected noise levels would continue to meet those considered satisfactory for the affected land use.

Non-residential Areas

An increase greater than 10 dB L_{dn} would be considered significant when projected noise levels would continue to meet those considered satisfactory for the affected land use, i.e. 70dB L_{dn} .

5.0 NOISE SURVEY DETAILS AND MEASURED NOISE LEVELS

An environmental noise survey was conducted in order to quantify the existing noise environment. The survey was conducted by Illingworth & Rodkin Inc. generally in accordance with *ISO 1996: 2007: Acoustics – Description, measurement and assessment of environmental noise*. Full details of the baseline noise survey are included in Appendix B of this document. The following sections summarize the findings.

5.1 Choice of Measurement Locations

A series of both unattended long-term and attended short-term surveys were conducted in order to determine the existing baseline noise environment.

A total of five unattended long-term monitoring positions were selected; each is described in turn below and shown on Figure 4.

- LT1** was selected to represent the noise environment of Sandy Beach Road residential land uses located along the waterfront.
- LT2** was on a bluff overlooking the project site and adjacent to condominium units located at the northwest terminus of Seawitch Lane.
- LT3** was selected to represent the noise environment of residential land uses within the Harbor Park Apartments and along Winchester Street.
- LT4** was selected to represent the noise environment of noise-sensitive land uses along Lemon Street, west of Sonoma Boulevard.
- LT5** quantified ambient noise levels from vehicular traffic along Sonoma Boulevard.

In addition a total of four attended short-term monitoring positions were selected; each is described in turn below and also shown on Figure 4.

- ST1** Lake Dalwigk Park, 70 feet from the center of Lemon Street at Sheridan Street. The measurement site represented the park and nearby residential land uses.
- ST2** 75 feet from the center of Sonoma Boulevard south of Solano Avenue. This location was selected to quantify ambient traffic noise levels along Sonoma Boulevard.
- ST3** Center of Alden Park, Mare Island and was selected to represent the noise environment at noise-sensitive receptors on Mare Island.
- ST4** Easternmost terminus of York Street and was selected to represent the noise environment at noise-sensitive receptors along the railroad corridor that leads to and from the project site.



Figure 4 Survey Locations

5.2 Survey Periods

Measurements were conducted over the following periods:

- Unattended locations – 18 September to 25 September 2013, and;
- Attended locations – 14:50hrs to 15:40hrs on 18 September 2013, and;
11:00hrs to 12:00hrs on 25 September 2013.

Appendix C provides detailed meteorological data for the survey period. In general the weather was dry with wind speeds in the range of 4 to 14mph and mean temperatures in the range of 61 to 80°F.

5.3 Procedure

Sample periods for the unattended noise measurements were 10 minutes in duration.

Sample periods for the attended noise measurements were 10 minutes in duration, with two samples recorded at all locations.

The results were noted onto a Survey Record Sheet immediately following each sample, and were also saved to the instrument memory for later analysis where appropriate. Survey personnel noted the primary noise sources contributing to noise build-up.

5.4 Measurement Parameters

Appendix A defines the measurement parameters used for presenting the noise data captured.

5.5 Results

5.5.1 Unattended Locations

The results for locations LT1 to LT5 are summarized in Table 3 below. Please note that the results summary excludes data measured on Saturday 21 September 2013 as there was a storm in the area which affected the measured results.

Location	Measured Noise Levels (dB re. 2×10^{-5} Pa)		
	L_{day}	L_{night}	L_{dn}
LT1	54	48	55
LT2	52	45	53
LT3	49	45	52
LT4	57	48	57
LT5	60	56	63

Table 3 Summary of Results for Unattended Locations

5.5.2 Attended Locations

The results for locations ST1 to ST5 are summarized in Table 4 below.

Location	Start Time	Measured Noise Levels (dB re. 2×10^{-5} Pa)					
		$L_{\text{Aeq,T}}$	$L_{\text{A1,T}}$	$L_{\text{A10,T}}$	$L_{\text{A50,T}}$	$L_{\text{A90,T}}$	L_{Amax}
ST1	1450	59	71	62	52	47	73
	1500	57	66	61	53	46	69
ST2	1520	62	72	66	59	53	74
	1530	63	70	67	61	53	72
ST3	1100	53	65	56	44	41	71
	1110	48	60	50	43	39	63
ST4	1140	51	61	55	48	46	61
	1150	49	54	51	49	47	57

Table 4 Summary of Results for Attended Locations

At monitoring location ST1 the primary source of noise was road traffic movement along Lemon Street. Ambient noise levels measured were in the range of 57 to 59dB $L_{\text{Aeq,10 minutes}}$.

At monitoring location ST2 the primary source of noise was road traffic movement along Sonoma Boulevard. Ambient noise levels measured were in the range of 62 to 63dB $L_{\text{Aeq,10 minutes}}$.

At monitoring location ST3 the primary source of noise was local road traffic. Ambient noise levels measured were in the range of 48 to 53dB $L_{\text{Aeq,10 minutes}}$.

At monitoring location ST4 the primary source of noise was local and distant road traffic. Ambient noise levels measured were in the range of 49 to 51dB $L_{\text{Aeq,10 minutes}}$.

5.6 Discussion of Results

Based on a review of the ambient long-term and short-term noise data and the relevant noise criteria discussed in Section 4.0, project-generated noise increasing the existing ambient by more than 5dB L_{dn} would be considered significant at Sandy Beach Road single-family residential land uses, multi-family residential units located along Seawitch Lane and within the Harbor Park Apartments, at single-family residences along Winchester Street, on Mare Island, or along the railroad corridor (receptors represented by LT1, LT2, LT3, ST3, or ST4).

Project-generated noise increasing the existing ambient by more than 3dB L_{dn} would be considered significant at noise-sensitive receptors represented by sites LT5, ST1, or ST2 (Lemon Street East of Sonoma Boulevard and Sonoma Boulevard).

Project-generated noise increasing the existing ambient by more than 10dB L_{dn} would be considered significant at receptors represented by site LT4 (Lemon Street West of Sonoma Boulevard) which are located within lands zoned for intensive use.

6.0 NOISE SENSITIVE LOCATIONS

For the purposes of the noise impact assessment the closest residential properties have been included in the noise modeling procedure in order to present the worst-case. Figure 5 indicates the location of the nearest noise sensitive locations assessed.

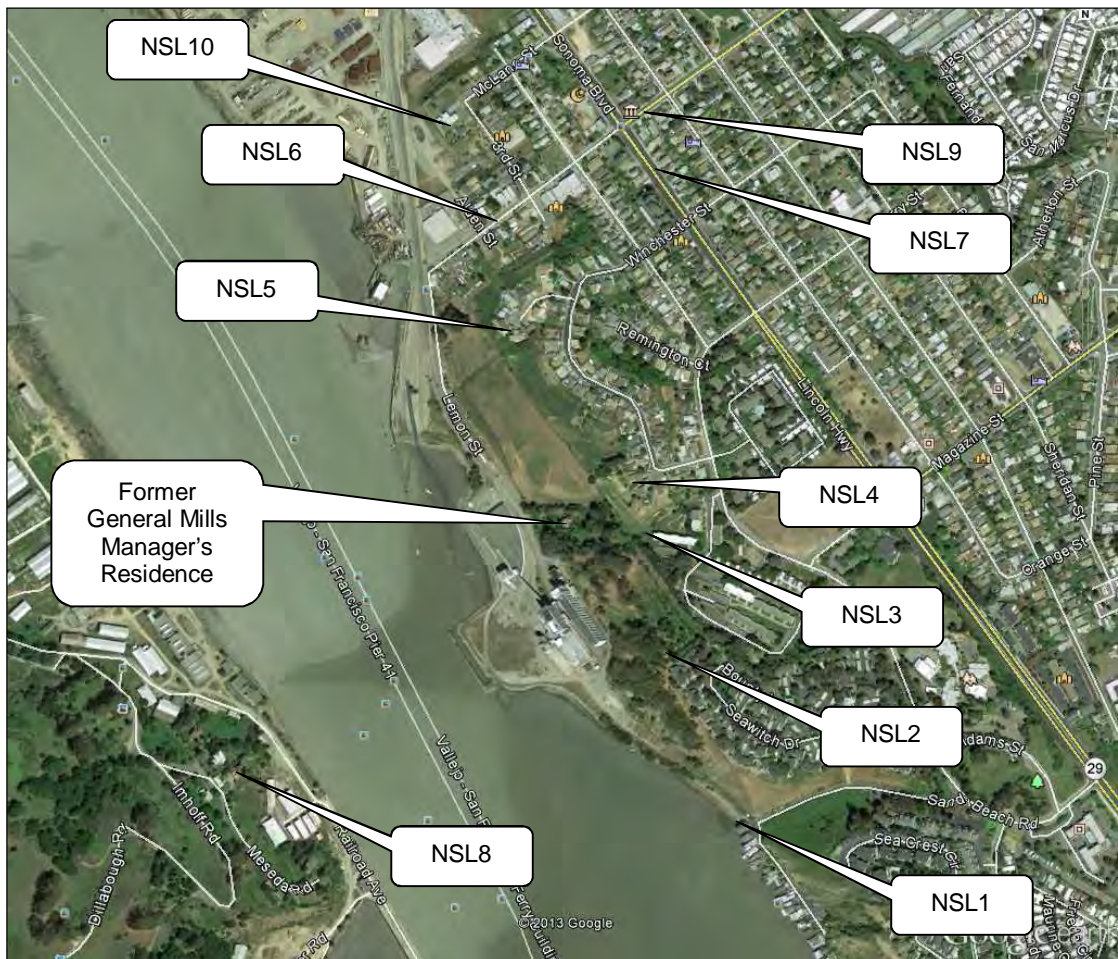

Figure 5 Noise Sensitive Locations

Table 5 describes each location in more detail.

Location	Description
NSL1	Sandy Beach Road Residences
NSL2	Seawitch Lane Residences
NSL3	Harbor Park Apartments
NSL4	Browning Way Residences
NSL5	Colt Ct Residences
NSL6	Lemon Street Residences West of Sonoma Blvd
NSL7	Sonoma Boulevard Residences
NSL8	Mare Island
NSL9	Lemon Street Residences East of Sonoma Blvd
NSL10	Residential Property near Rail Tracks on 3 rd Street

Table 5 Noise Sensitive Locations

Please note that the former General Mills manager’s residence located within the site boundary is no longer a habitable residence.

7.0 CONSTRUCTION PHASE ASSESSMENT

Short-term noise and vibration impacts may occur during the site preparation and construction phases of the project. The following sections discuss the potential impacts that may occur.

7.1 Construction Noise

To assess the construction noise levels the *Roadway Construction Noise Model* (RCNM) developed by the Federal Highway Administration (FHWA) has been used. Each phase of the construction activity has been assessed for the three closest noise sensitive locations to the development site, i.e. NSL1, NSL2 and NSL3.

It should be noted that the Vallejo Noise Ordinance does not specify limit values for construction noise. Instead the City proposes allowable hours for construction activity within the Noise Element in Policy 2b. The recommended allowable hours are 7:00am to 9:00pm.

Furthermore, Section 16.72.050 of the Vallejo Code of Ordinances states that in relation to the maximum permissible sound levels within the Performance Standard Regulations, sounds from temporary construction or demolition work may exceed these maximum sound pressure levels upon compliance with state conditions.

Two types of short-term noise impacts would occur during site preparation and project construction. The impacts will include:

- Increase in traffic flow on local streets associated with the transport of workers, equipment and materials to and from the project site, and;
- Heavy construction equipment operating on the project site.

The first type of impact would result from the increase in traffic flow on local streets, associated with the transport of workers, equipment, and materials to and from the project site. The transport of workers and construction equipment and materials to the project site will incrementally increase noise levels on access roads leading to the site. During the worst-case periods of construction it is estimated that there will be up to 5 deliveries to site using heavy trucks per day.

Because workers and construction equipment will use existing routes, noise from slow moving passing trucks (75 dBA L_{max} at 50 feet) would be similar to existing vehicle generated noise. For this reason, short-term intermittent noise from trucks will be minor when averaged over a longer time period. In addition, according to the City's noise ordinance, noise from temporary transportation of goods or people to and from a given premises is exempt from the City's noise standards. It should also be noted that noise emission levels from vehicles themselves (such as muffler requirements) are regulated by federal and State governments and are exempt from local government regulations. Therefore, short-term construction-related noise associated with worker and equipment transport to the proposed project site will result in a less-than-significant impact on receptors along the access routes leading to the proposed project site.

The second type of short-term noise impact is related to the noise generated by heavy construction equipment operating on the project site. Noise generated during demolition, excavation, grading, site preparation, and building erection on the project site would result in potential noise impacts on offsite uses. Existing receptors in the vicinity, as discussed in Section 6.0, would be subject to short-term noise generated by construction equipment and activities on the project site when construction occurs.

Construction is performed in discrete phases, each of which has its own mix of equipment and, consequently, its own noise characteristics. These phases would change the character of the noise generated on the project site and, therefore, the noise levels surrounding the site as construction progresses. Despite the variety in the type and size of construction equipment, similarities in the dominant noise sources and patterns of operation allow construction related noise ranges to be categorized by work phase. Table 6 lists construction equipment noise levels for the types of equipment likely to be used on this project. The noise levels are based on a distance of 50 feet between the equipment and a noise receptor.

Type of Equipment	Acoustical Usage Factor (%)	L_{max} @ 50 feet (dBA, slow)
All Other Equipment > 5 HP	50	85
Backhoe	40	80
Clam Shovel (dropping)	20	93
Compactor (ground)	20	80
Compressor (air)	40	80
Concrete Mixer Truck	40	85
Concrete Pump Truck	20	82
Concrete Saw	20	90
Crane	16	85
Dozer	40	85
Drum Mixer	50	80
Dump Truck	40	84
Excavator	40	85
Flat Bed Truck	40	84
Front End Loader	40	80
Generator	50	82
Grapple (on backhoe)	40	85
Jackhammer	20	85
Man Lift	20	85
Mounted Impact Hammer (hoe ram)	20	90
Pickup Truck	40	55
Pneumatic Tools	50	85
Pumps	50	77
Roller	20	85
Tractor	40	84
Vacuum Street Sweeper	10	80
Welder/Torch	40	73

Table 6 Typical Construction Noise Levels

Typical noise levels range up to 95 dBA L_{max} at 50 feet during the noisiest construction phases. The site preparation phase and the demolition phase, which includes impact hammers to break concrete, tend to generate the highest noise levels. Earthmoving equipment includes excavating machinery such as backhoes, bulldozers, front loaders, compactors, scrapers, and graders. Typical operating cycles for these types of construction equipment may involve one or two minutes of full-power operation followed by three or four minutes at lower power settings.

Demolition of existing structures and construction of the proposed project is expected to require the use of earthmovers such as bulldozers and scrapers, loaders and graders, water trucks, and dump trucks. As shown in Table 6, the typical maximum noise level generated by mounted impact hammers on the proposed project site is assumed to be 90 dBA L_{max} at 50 feet from the operating equipment. The maximum

noise level generated by excavators and bulldozers is approximately 85 dBA L_{max} at 50 feet.

Table 7 presents the predicted maximum noise levels at these nearest noise sensitive locations for a range of expected construction activities. Appendix D presents the calculation sheets for each activity and location.

Construction Activity	Type of Equipment	Predicted dBA L_{max} Levels		
		NSL1	NSL2	NLS3
Demolition	Front End Loader	52	61	57
	Excavator (x2)	57	66	62
	Crane	53	63	59
	Mounted Impact Hammer (hoe ram)	63	72	69
	Grapple (on backhoe)	60	69	65
	Dump Truck	49	58	55
Ground Works & Excavation	Backhoe	50	60	56
	Excavator (x2)	57	66	62
	Front End Loader	52	61	57
	Roller	53	63	59
	Tractor	57	66	62
	Vacuum Street Sweeper	54	64	60
Concrete & Steel Works	Concrete Mixer Truck	52	61	52
	Concrete Pump Truck	55	64	54
	Concrete Saw	63	72	62
	Crane	54	63	53
	Drum Mixer	53	63	53
	Flat Bed Truck	48	57	47
	Pneumatic Tools	59	68	58
	Welder/Torch	47	57	47

Table 7 Typical Construction Noise Levels at Sensitive Locations

The closest noise sensitive land uses to the project construction areas are NSL1, NSL2 and NSL3 which overlook the project site. These properties are located between 400 and 1,475 feet from the construction activity. At these distances, maximum noise levels from construction activities at the building site could range from 45dB(A) up to 75dB(A) L_{max} at the property line of the nearest sensitive locations.

In summary, the construction phase has the potential to generate a substantial temporary increase in ambient noise levels in the vicinity of the project. However, implementation of the following multi-part mitigation measure would reduce potential construction period noise impacts.

- All construction equipment must have appropriate sound muffling devices, which shall be properly maintained and used at all times such equipment is in operation.
- Where feasible, the project contractor shall place all stationary construction equipment so that emitted noise is directed away from sensitive receptors nearest the project site.
- The construction contractor shall locate on-site equipment staging areas so as to maximize the distance between construction-related noise sources and noise-sensitive receptors nearest the project site.

- Except as otherwise permitted, construction activities shall be restricted to the hours of 7:00 a.m. to 9:00 p.m. daily.

7.2 Construction Vibration

Construction activities associated with implementation of the proposed project could temporarily expose persons in the vicinity of the project site to excessive groundborne vibration or groundborne noise levels. Typical vibration source levels for construction equipment are shown in Table 8.

Type of Equipment		V _{dB} @ 25 feet
Pile Driver (impact)	Upper Range	112
	Typical	104
Pile Driver (sonic)	Upper Range	105
	Typical	93
Clam shovel drop (slurry wall)		94
Hydromill (slurry wall)	In Soil	66
	In Rock	75
Vibratory roller		94
Hoe ram		87
Large bulldozer		87
Caisson drilling		87
Loaded trucks		86
Jackhammer		79
Small bulldozer		58

Table 8 Typical Construction Ground Vibration Levels (Federal Transit Administration, 2006. *Transit Noise and Vibration Impact Assessment*. May.)

Typical groundborne vibration levels measured at a distance of 25 feet from heavy construction equipment in full operation, such as piling, range up to approximately 112 V_{dB}.

The Vallejo City Performance Standards (Chapter 16.72 of the Code of Ordinances) restrict any land use from producing vibration levels that are discernible without instruments at any point on the property line on which the use is located. Groundborne vibration levels from the operation of heavy construction equipment that will be used in demolition or construction of the proposed project would not be expected to cause damage to residential buildings of normal northern California construction.

In this instance given the location of the nearest sensitive receptors to the site and the distance between them and the construction activity, it is not considered likely that there will be any perceptible vibration during construction activity. Therefore, there will be no vibration generated during the construction phase that would expose people to excessive groundborne vibration or groundborne noise levels;

8.0 OPERATIONAL PHASE ASSESSMENT

The following sections will assess the noise and vibration impacts of the Orcem facility for the following activities:

- Fixed & mobile plant noise emissions;
- Ship unloading activity;
- Rail activity, and;
- Additional vehicular traffic on the public road network.

8.1 Orcem Activities

The Orcem Plant production process involves four key elements with regard to noise generation as follows:

1. Transport to and storage of raw materials on the Site, including Granulated Blast Furnace Slag (GBFS), cement and other additives;
2. Transport of raw material from storage to the Process Plant;
3. Drying, grinding and blending GBFS granulate and other raw materials and additives, and;
4. Transport of finished GGBS and cements to markets.

The development is proposed to be implemented on a scaled basis over two phases. The phases are:

- Phase 1:** Up to a production of 500,000 tons per year.
Phase 2: Above 500,000 tons per year.

In addition, the facility will be capable of operating in several modes as follows:

1. GGBS production only.
2. Cement Production only.
3. Both GGBS & Cement Production together but in independent production runs.

The mode of operation has an impact on the volume of vehicular movements on the local road network as certain modes require the importation of raw material via the road network in addition to the importation of material by ship. In addition, Modes 2 and 3 require a Clinker Storage building and associated mechanical plant to be constructed. This building is not required for Mode 1 operation. This will be discussed in more detail in the following sections.

8.2 Fixed Plant Noise Emissions

The drying, grinding and blending of processed raw materials to form the finished product involves the use of a variety of fixed plant on the Orcem site. The noise sources on the site can be separated into the following general categories:

- grinding mill;
- main fan;
- hot gas burner;
- bag filter fans;
- air slide fans;
- conveyor belt motors, and;
- elevator motors.

Noise emission data for each of these sources has been provided by equipment suppliers. Table 9 below lists the noise emission values for each source; detailed data sheets are included in Appendix E. The reference system used in the table below has been taken from the equipment schedule supplied by Orcem and the drawings indicating the location of each source are provided in Appendix F.

Reference	Description	Noise Emission Level
513-FN1 ^{Note A}	Bag Filter Fan	92dB L _{Aeq} @ 5ft (See 110kW fan data sheet)
513-BC1 ^{Note A}	Conveyor Belt Motor (15HP/11Kw)	59dB L _{Aeq} @ 3ft (See ABB Catalog in Appendix E)
513-BC2 ^{Note A}	Conveyor Belt Motor (75HP/56Kw)	71dB L _{Aeq} @ 3ft (See ABB Catalog in Appendix E)
TBC ^{Note A}	Clinker Building Dedusting Fans (8 No. in Total)	82dB L _{Aeq} @ 3ft (See Dalamatic Catalog in Appendix E)
521-FN1	Bag Filter Fan	88dB L _{Aeq} @ 5ft (See 44kW fan data sheet)
521-BC1	Conveyor Belt Motor (5.5HP/4Kw)	59dB L _{Aeq} @ 3ft (See ABB Catalog in Appendix E)
521-BC2	Conveyor Belt Motor (5.5HP/4Kw)	59dB L _{Aeq} @ 3ft (See ABB Catalog in Appendix E)
521-BE1	Elevator (50HP/67Kw)	66dB L _{Aeq} @ 3ft (See ABB Catalog in Appendix E)
521-FN2	Bag Filter Fan	80dB L _{Aeq} @ 5ft (See 11kW fan data sheet)
531-BC1	Conveyor Belt Motor (20HP/15Kw)	60dB L _{Aeq} @ 3ft (See ABB Catalog in Appendix E)
531-AB1	Air Shock	89dB L _{Aeq} @ 3ft (See measured value in Appendix E)
Hot Gas Burner*		92dB L _{Aeq} internally within building (See measured value in Appendix E)
561-FN1	Main Fan	78dB L _{Aeq} @ 3ft (See Pollroch data in Appendix E)
561-CH1	Stack [†]	108dB L _{WA} (See Pollroch data in Appendix E)
Grinding Mill & Ancillary Equipment*		88dB L _{Aeq} internally within Mill Building (See Messbericht data in Appendix E)
591-FA1	Air Slide Fan	80dB L _{Aeq} @ 5ft (See 11kW fan data sheet)
591-FA2	Air Slide Fan	80dB L _{Aeq} @ 5ft (See 11kW fan data sheet)
591-FA3	Air Slide Fan	80dB L _{Aeq} @ 5ft (See 11kW fan data sheet)
591-FA4	Air Slide Fan	80dB L _{Aeq} @ 5ft (See 11kW fan data sheet)
591-FN1	Bag Filter Fan	80dB L _{Aeq} @ 5ft (See 11kW fan data sheet)
591-FN2	Bag Filter Fan	80dB L _{Aeq} @ 5ft (See 11kW fan data sheet)
591-FN3	Bag Filter Fan	80dB L _{Aeq} @ 5ft (See 11kW fan data sheet)
591-FN5	Air Slide Fan	80dB L _{Aeq} @ 5ft (See 11kW fan data sheet)
591-FN6	Air Slide Fan	80dB L _{Aeq} @ 5ft (See 11kW fan data sheet)
591-BE1	Elevator (30HP/22Kw)	63dB L _{Aeq} @ 3ft (See ABB Catalog in Appendix E)
611-FA1	Air Slide Fan	80dB L _{Aeq} @ 5ft (See 11kW fan data sheet)
611-FA2	Air Slide Fan	80dB L _{Aeq} @ 5ft (See 11kW fan data sheet)
611-FN1	Bag Filter Fan	80dB L _{Aeq} @ 5ft (See 11kW fan data sheet)
611-BE1	Elevator (20HP/15Kw)	60dB L _{Aeq} @ 3ft (See ABB Catalog in Appendix E)
612-FA1	Air Slide Fan	80dB L _{Aeq} @ 5ft (See 11kW fan data sheet)
612-FA2	Air Slide Fan	80dB L _{Aeq} @ 5ft (See 11kW fan data sheet)
612-FN1	Bag Filter Fan	80dB L _{Aeq} @ 5ft (See 11kW fan data sheet)
612-BE1	Elevator (20HP/15Kw)	60dB L _{Aeq} @ 3ft (See ABB Catalog in Appendix E)
621-FA1	Air Slide Fan*	80dB L _{Aeq} @ 5ft (See 11kW fan data sheet)
622-FN1	Fan for Chute*	80dB L _{Aeq} @ 5ft (See 11kW fan data sheet)
622-FA1	Air Slide Fan*	80dB L _{Aeq} @ 5ft (See 11kW fan data sheet)
622-FN2	Fan for Chute*	80dB L _{Aeq} @ 5ft (See 11kW fan data sheet)

Table 9 Noise Emission Values Utilized in the Noise Model

- Note A This plant is only required during operating modes 2 & 3 when the Clinker store is constructed.
- Note * These plant items are located internally within buildings on site. The sound insulation performance of the buildings will be taken into account when calculating the overall noise impact.
- Note † The noise emission from the stack has been calculated using the sound power of the main fan (See Appendix E) corrected for the stack dimensions and the directivity index calculated using the Strouhal number over frequency. Appendix G details the noise reduction included in this assessment. Further details on the method used are found in Section 9.15 of Engineering Noise Control Theory and Practice, D.A. Bies & C. H. Hansen, 3rd Edition, 2003.

In addition to the fixed plant noise sources there will also be mobile plant operating on the Orcem site. The mobile plant will be a single diesel powered wheeled loader with a bucket capacity of approximately 7 tonnes. The loader will transfer raw material to the mill feed hopper. Figure 6 illustrates where the loader will operate.

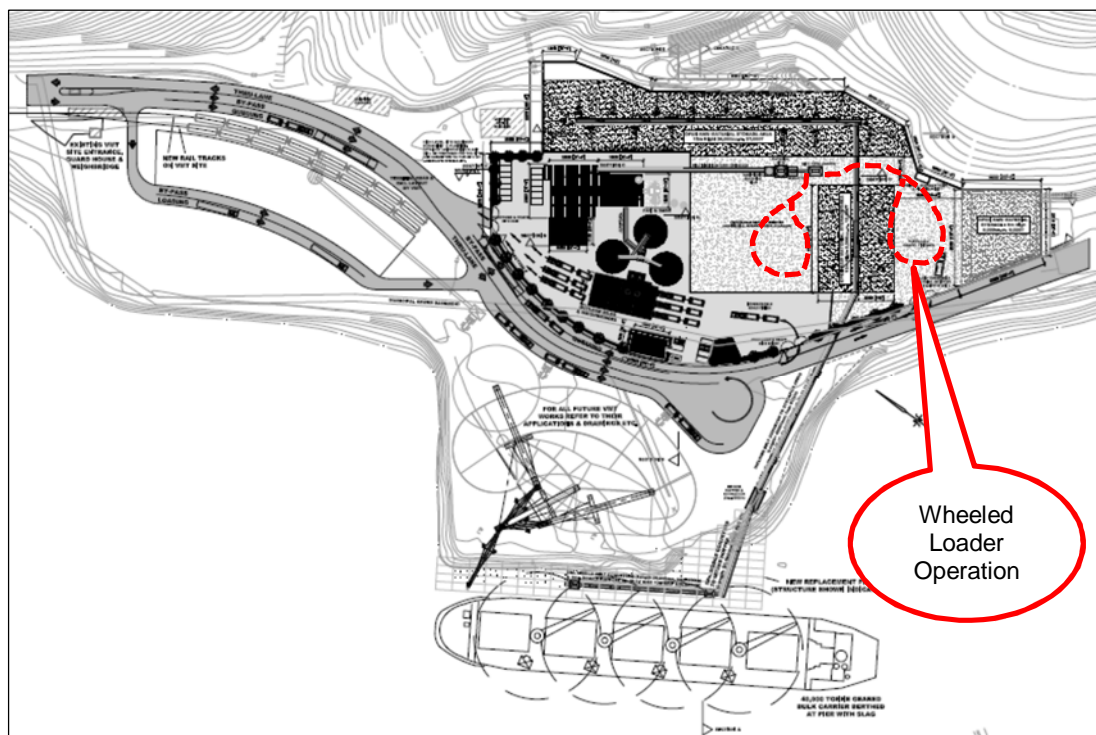

Figure 6 Wheeled Loader Operation

A single loader will operate on site and for the purposes of the noise impact assessment the following assumptions have been made:

- Guaranteed Sound Power Level (L_{WA}) – 113dB(A)¹;
- Vehicle velocity on site – 10mph, and;
- Throughput – 20 feeds per hour to the Mill Intake Hopper.

The mobile plant will operate in conjunction with the fixed plant operation during each phase of operation.

Appendix H provides details of the noise modeling carried out to predict the noise emission from the fixed plant installation based on the source data discussed here. The noise levels at the noise sensitive locations discussed in Section 6.0 have been predicted based on these noise emission levels and taking into account the attenuation over distance, ground topography and downwind conditions. The calculation also takes into account the sound insulation performance of the buildings

¹ Noise Emission from Outdoor Equipment Database
http://ec.europa.eu/enterprise/sectors/mechanical/noise-outdoor-equipment/database/index_en.htm

on site where plant is housed. Table 10 below lists the assumed performance of the building cladding.

Item	Sound Reduction Index Octave Band Centre Frequency (Hz)							
	63	125	250	500	1k	2k	4k	8k
Building Cladding	14	14	19	24	27	34	42	52

Table 10 Sound Insulation Performance of Building Cladding

This degree of sound insulation can be achieved by a typical insulated cladding panel. Tables 11 & 12 present the predicted noise level at each location for the following phases of operation:

- Phase 1 – plant in operation for 11hrs out of a 24 hour period, concentrated at the night-time period when energy prices are lowest (21:00hrs to 08:00hrs), and;
- Phase 2 – plant in operation for 23hrs out of a 24 hour period.

The predicted noise level at each location is presented in terms of the following noise descriptors:

- L_{day} ;
- L_{night} , and;
- L_{dn} .

Location	Phase 1								
	Mode 1			Mode 2			Mode 3		
	L_{day}	L_{night}	L_{dn}	L_{day}	L_{night}	L_{dn}	L_{day}	L_{night}	L_{dn}
NSL1	39	47	53	43	47	53	43	47	53
NSL2	48	57	62	54	57	62	54	57	62
NSL3	46	55	60	48	54	60	48	54	60
NSL4	45	54	59	49	54	59	49	54	59
NSL5	32	41	46	37	41	47	37	41	47
NSL6	28	37	42	34	37	43	34	37	43
NSL7	28	37	42	34	37	43	34	37	43
NSL8	38	47	53	44	47	53	44	47	53
NSL9	24	33	38	30	33	39	30	33	39
NSL10	33	41	47	36	42	47	36	42	47

Table 11 Noise Levels due to Fixed Plant Serving the Orcem Site – Phase 1

Location	Phase 2								
	Mode 1			Mode 2			Mode 3		
	L_{day}	L_{night}	L_{dn}	L_{day}	L_{night}	L_{dn}	L_{day}	L_{night}	L_{dn}
NSL1	44	48	54	45	48	54	45	48	54
NSL2	56	60	66	59	60	66	59	60	66
NSL3	47	55	60	50	55	60	50	55	60
NSL4	48	54	60	51	54	60	51	54	60
NSL5	35	42	47	39	42	47	39	42	47
NSL6	32	38	43	35	38	44	35	38	44
NSL7	34	39	44	37	39	45	37	39	45
NSL8	40	47	53	44	47	53	44	47	53
NSL9	32	35	41	34	36	41	34	36	41
NSL10	35	42	47	38	42	48	38	42	48

Table 12 Noise Levels due to Fixed Plant Serving the Orcem Site – Phase 2

Appendix I gives the detailed breakdown of each noise sources contribution to the overall L_{dn} level at each receiver location.

8.3 Ship Unloading

The principal raw materials to be processed in the Proposed Project will be GBFS and Clinker. These materials will arrive at the proposed upgraded dock to be owned and operated by Vallejo Marine Terminal LLC (VMT). Two types of ship will be utilized as follows:

Geared Ships Nominally a 40,000mt bulk carrier with on board cranes (geared ship). This ship will berth at the dock and the raw material on board will be discharged from the ship using clamshell grabs fitted to the on board cranes. The clamshell grabs will lift the raw material from the ship holds and deposit it into mobile hoppers located on the dock.

Self-Discharge Ships Nominally a 40,000mt bulk carrier with on board reclaim conveyors and a discharge boom with an integral belt conveyor (self-discharge ship). This ship will berth at the dock and the raw material on board will be discharged from the ship via the self-discharge boom which will swing into the required position and transport the raw material from the ship and deposit it into receiving hopper located on the shore.

The following text describes the raw material transport systems:

- The mobile hoppers at the dockside will feed onto a common mobile conveyor system. A continuous, covered belt conveyor system will transport material from the shipside hopper all the way to the storage areas.
- In the case of GBFS material, the conveyor system will discharge the GBFS in the area of the open stockyard floor.
- In the case of clinker material, the conveyor system will discharge the clinker using an internal conveyor with a belt tipper in the Orcem Project's covered storage building.

The noise impact of this activity has been modeled using the methodology outlined in *ISO 9613-2:1996 Acoustics – Attenuation of sound outdoors – Part 2: General method of calculation*.

For the purposes of the noise impact assessment the following assumptions have been made with regard to the noise source emissions:

- Noise emission levels from fixed plant, i.e. hoppers, conveyors etc., as listed in Table 13, and;
- Guaranteed Sound Power Level of Hydraulic Excavator (L_w) – 111dB(A)².

² Noise Emission from Outdoor Equipment Database
http://ec.europa.eu/enterprise/sectors/mechanical/noise-outdoor-equipment/database/index_en.htm

Reference	Description	Noise Emission Level
N/A	Ship 20,000 – 60,000 tons	95dB L _{WA} (SourcedB+ v2.02 ³)
	Transloading of Material	65dB L _{WA} /m ² (SourcedB+ v2.02)
510-FN1	Aspirated Hopper Fan	88dB L _{Aeq} @ 5ft (See 44kW fan data sheet)
510-FN2	Aspirated Hopper Fan	88dB L _{Aeq} @ 5ft (See 44kW fan data sheet)
510-BC1	Conveyor Belt Motor (30HP/22Kw)	63dB L _{Aeq} @ 3ft (See ABB Catalog in Appendix D)
510-BC2	Conveyor Belt Motor (30HP/22Kw)	63dB L _{Aeq} @ 3ft (See ABB Catalog in Appendix D)
510-BC3	Conveyor Belt Motor (60HP/45Kw)	71dB L _{Aeq} @ 3ft (See ABB Catalog in Appendix D)
510-BC4	Conveyor Belt Motor (75HP/56Kw)	71dB L _{Aeq} @ 3ft (See ABB Catalog in Appendix D)
510-BC5	Conveyor Belt Motor (75HP/56Kw)	71dB L _{Aeq} @ 3ft (See ABB Catalog in Appendix D)
511-BC1	Conveyor Belt Motor (25HP/19Kw)	63dB L _{Aeq} @ 3ft (See ABB Catalog in Appendix D)
511-BC2	Conveyor Belt Motor (200HP/149Kw)	77dB L _{Aeq} @ 3ft (See ABB Catalog in Appendix D)
511-BC3	Conveyor Belt Motor (70HP/52Kw)	71dB L _{Aeq} @ 3ft (See ABB Catalog in Appendix D)
511-BC4	Conveyor Belt Motor (85HP/63Kw)	66dB L _{Aeq} @ 3ft (See ABB Catalog in Appendix D)
511-FN1	Aspirated Hopper Fan	88dB L _{Aeq} @ 5ft (See 44kW fan data sheet in Appendix D)

Table 13 Noise Emission Values Utilized in the Noise Model for Ship Unloading

Using the input data discussed here and assuming that the unloading activity occurs continuously (i.e. 24hours per day) while a ship is at dock the noise impact on the nearest sensitive locations has been predicted and is presented in Table 14.

Location	Phase 1 & 2 All Modes		
	L _{day}	L _{night}	L _{dn}
NSL1	39	40	46
NSL2	43	44	50
NSL3	33	34	40
NSL4	37	38	44
NSL5	32	32	39
NSL6	25	26	32
NSL7	22	22	28
NSL8	42	42	49
NSL9	22	23	29
NSL10	32	33	39

Table 14 Noise Levels due to Orcem Ship Unloading Activity

³ IMAGINE Improved Methods for the Assessment of the Generic Impact of Noise in the Environment, Industrial Noise Source Database <http://www.softnoise.com/pdf/IMA07TR-050418-DGMR02.pdf>

8.4 Truck Movements on Local Road Network

During the operational phase of the Orcem facility there will be additional heavy truck movements to and from the site using the local road network. The truck movements will be a combination of bulk material import and also the export of finished product from the facility. The number of truck movements serving the site therefore depends on the mode and phase of operation.

Table 16 below lists the average hourly two-way truck movements (i.e. empty tanker in and full load out) to the site during the day and night-time periods for each mode of operation as follows:

1. GGBS production only.
2. Cement Production only.
3. Both GGBS & Cement Production together but in independent production runs.

Please note that the figures in Table 16 represent the maximum truck movements for each phase⁴. The increase in truck volume to the site will occur gradually as the facility grows its business. However, the figures used here represent the maximum projected truck traffic for each phase and mode of operation, i.e. mode milestones 1.4, 2.4 and 3.4 for Phase 1 and mode milestones 1.5, 2.5 & 3.5 for Phase 2.

Period	Phase 1			Phase 2		
	Mode 1.4	Mode 2.4	Mode 3.4	Mode 1.5	Mode 2.5	Mode 3.5
Daytime (07:00hrs to 22:00hrs)	6	10	8	10	16	12
Night-time (22:00hrs to 07:00hrs)	10	14	10	14	22	16

Table 16 Hourly Average Truck Movements to the Orcem Site

The traffic volumes listed in Table 16 are to be considered worst-case as they assume that bulk deliveries by road occur simultaneously to the export of finished product. However, it is probable that the bulk deliveries to the site will be much less frequent over the course of a full year's production.

The haul route to and from the site will be via Lemon Street to the junction with Sonoma Boulevard at which point the traffic will either:

- Route 1 – Lemon Street, turning right onto 780 and then north on 80;
- Route 2 – Lemon Street, turning right onto 780;
- Route 3 – Lemon Street, turning right onto Sonoma Blvd, and;
- Route 4 – Lemon Street, turning left onto Sonoma Blvd.

The distribution of traffic to each of these routes has been provided by the project team as follows:

- Route 1 – 38%;
- Route 2 – 18%
- Route 3 – 39%; and
- Route 4 – 5%.

Taking all of this into account and assuming an average truck speed of 20mph on all routes the predicted noise levels from truck movements serving the Orcem site are

⁴ Taken from Table 4 of the Transportation/Traffic Information Technical Studies Submission dated 28 January 2014.

presented in Tables 17 and 18 below. Please note that some receivers are not influenced by truck movements on the local road network as they are positioned away from the road network.

Location	Phase 1								
	Mode 1.4			Mode 2.4			Mode 3.4		
	L _{day}	L _{night}	L _{dn}	L _{day}	L _{night}	L _{dn}	L _{day}	L _{night}	L _{dn}
NSL1	--	--	--	--	--	--	--	--	--
NSL2	32	34	40	34	36	42	33	34	41
NSL3	29	32	38	32	33	39	31	32	38
NSL4	31	33	39	33	35	41	32	33	40
NSL5	42	44	50	44	45	51	43	44	50
NSL6	54	56	62	56	57	64	55	56	62
NSL7	48	51	57	51	53	59	51	51	58
NSL8	--	--	--	--	--	--	--	--	--
NSL9	52	54	60	54	55	61	52	54	60
NSL10	--	--	--	--	--	--	--	--	--

Table 17 Noise Levels due to Truck Movements Serving the Orcem Site – Phase 1

Location	Phase 2								
	Mode 1.5			Mode 2.5			Mode 3.5		
	L _{day}	L _{night}	L _{dn}	L _{day}	L _{night}	L _{dn}	L _{day}	L _{night}	L _{dn}
NSL1	--	--	--	--	--	--	--	--	--
NSL2	34	36	42	36	38	44	35	36	43
NSL3	32	33	39	34	35	41	32	34	40
NSL4	33	35	41	35	37	43	34	35	42
NSL5	44	45	51	46	47	53	45	46	52
NSL6	56	57	64	58	59	66	57	58	64
NSL7	51	53	59	54	55	61	53	54	60
NSL8	--	--	--	--	--	--	--	--	--
NSL9	54	55	61	55	57	63	54	55	61
NSL10	--	--	--	--	--	--	--	--	--

Table 18 Noise Levels due to Truck Movements Serving the Orcem Site – Phase 2

Appendix J presents the detailed noise model results for each model at each noise sensitive location.

8.5 Rail Activity

The existing railway serving the site may also be used by Orcem to both import raw material and possibly export finished product. The volume of material to be transported by train per month will depend on the phase of operation; however, regardless of the monthly volume throughput a maximum of one train movement to and from the site during any single 24 hour period is representative of the worst-case for all phases and modes. The following narrative outlines the import/export methodology by rail for the Orcem site:

- Arriving trains, either laden or unladen, will be parked in the proposed rail yard area to be located on the existing tracks outside the site boundary. It is expected that trains will arrive with 17 railcars;
- The railcars will then be shunted from this yard area to the rail transloading area on the site where there is capacity for 10 railcars, two train movements per hour between the rail transloading area and the yard area are assumed (i.e. one movement in and one movement out);
- Locomotive will not idle within the yard while waiting to shunt railcars;
- Product import/export will be transloaded to or from the railcars using sealed trucks which pump the product to or from the railcar;
- Loaded or unloaded railcars will be shunted back to the rail yard area outside the site boundary to await collection by the locomotive, and;
- It is expected to take up to 9 hours to load or unload a train.

Figure 7 illustrates the location of each area discussed above.

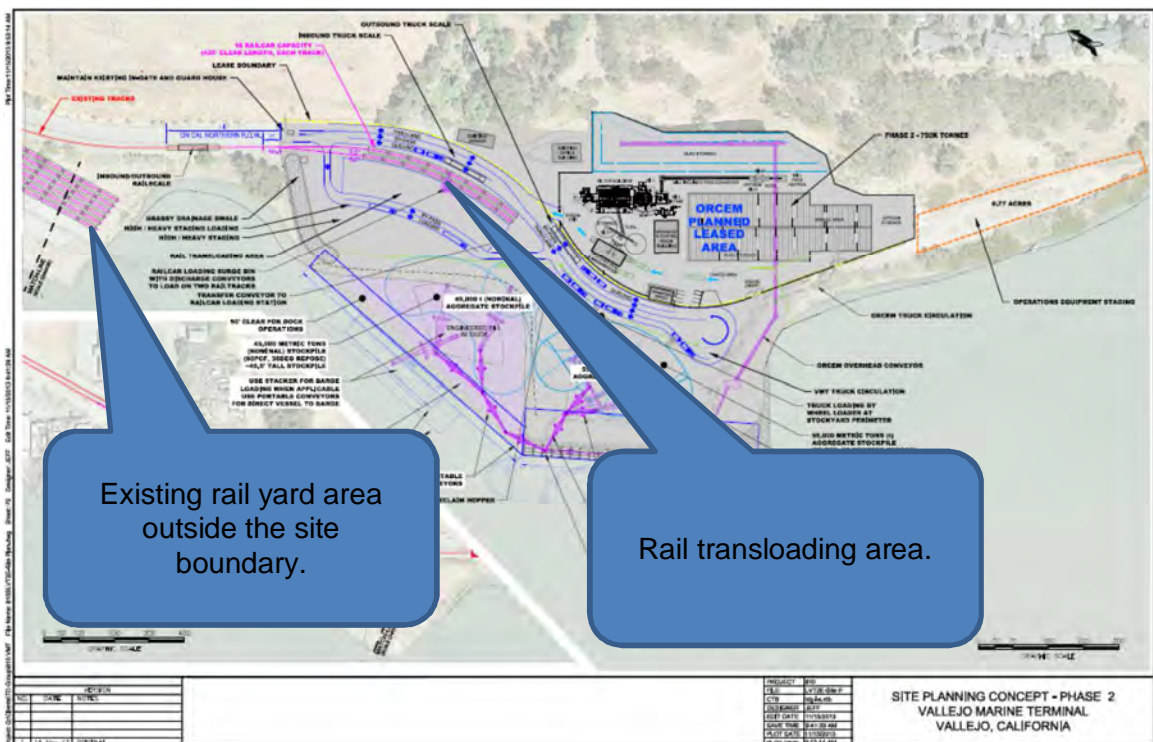

Figure 7 Rail Activity on Site

When assessing the noise impact of rail activity use was made of the Chicago Rail Efficiency and Transportation Efficiency (CREATE) railroad noise modeling spread sheet which is based on the Federal Transit Administration (FTA) procedures for the assessment of transit noise and vibration.

Please note that the model inputs above have been chosen in order to present a worst-case impact assessment. In certain instances the actual operation of the rail activity will have a lesser impact due to the conservative assumptions made here. Table 19 lists the model inputs used in this instance.

Model Input	Rail Yard Area	Trains Arriving/Leaving			Shunting between Yard & Site		
	Rail Yard	Freight Loco	Freight Cars	Cross-over Tracks	Freight Loco	Freight Cars	Cross-over Tracks
Trains per hour	2	1	1	1	2	2	2
Speed (mph)	n/a	5	5	n/a	5	5	n/a
Duration of 1 train (secs)	n/a	n/a	n/a	114	n/a	n/a	33
Locos/train	n/a	1	n/a	n/a	1	n/a	n/a
Length of cars/train (ft)	n/a	n/a	800	n/a	n/a	220	n/a
Wheel Flats?	n/a	n/a	Yes	n/a	n/a	Yes	n/a
% of Cars with Wheel Flats	n/a	n/a	3%	n/a	n/a	3%	n/a
Jointed Track?	Yes	Yes	Yes	Yes	Yes	Yes	Yes
Embedded Track?	No	No	No	No	No	No	No
Aerial Structure?	No	No	No	No	No	No	No
Barrier Present?	No	No	No	No	No	No	No
Intervening Rows of Buildings	0	0	0	0	0	0	0

Table 19 CREATE Noise Model Inputs for Orcem

Table 20 lists the predicted noise level from all rail sources discussed above at the nearest noise sensitive locations.

Location	Rail Yard Activity		Shunting Between Yard and Site		Trains Arriving/Leaving	
	Distance to Activity, feet	L _{Aeq, 1hr}	Distance to Activity, feet	L _{Aeq, 1hr}	Distance to Activity, feet	L _{Aeq, 1hr}
NSL1	2,920	28	2,015	43	3,100	38
NSL2	2,000	32	1,080	47	2,660	39
NSL3	1,455	36	690	50	2,065	41
NSL4	1,280	37	655	50	1,935	41
NSL5	460	48	460	52	790	47
NSL6	575	46	575	51	575	49
NSL7	1,600	35	1,600	44	1,600	42
NSL8	2,100	32	2,100	43	2,100	41
NSL9	1,600	35	1,600	44	1,600	42
NSL10	1,080	39	790	49	240	55

Table 20 Noise Levels due to Orcem Rail Activity

In addition to the rail activity noise it is also necessary to consider the noise from truck movements to and from the rail transloading area that will occur when loading or unloading a train. Based on the volume of material to be transported by rail and the 9 hour loading period, a total of 66 truck loads are required between the Orcem facility and the train loading area. The noise impact of this truck traffic volume has

been modeled using the TNM methodology discussed previously for a traffic speed of 10mph. Figure 8 illustrates the route that these truck movements will take when moving between the Orcem facility and the rail loading area.

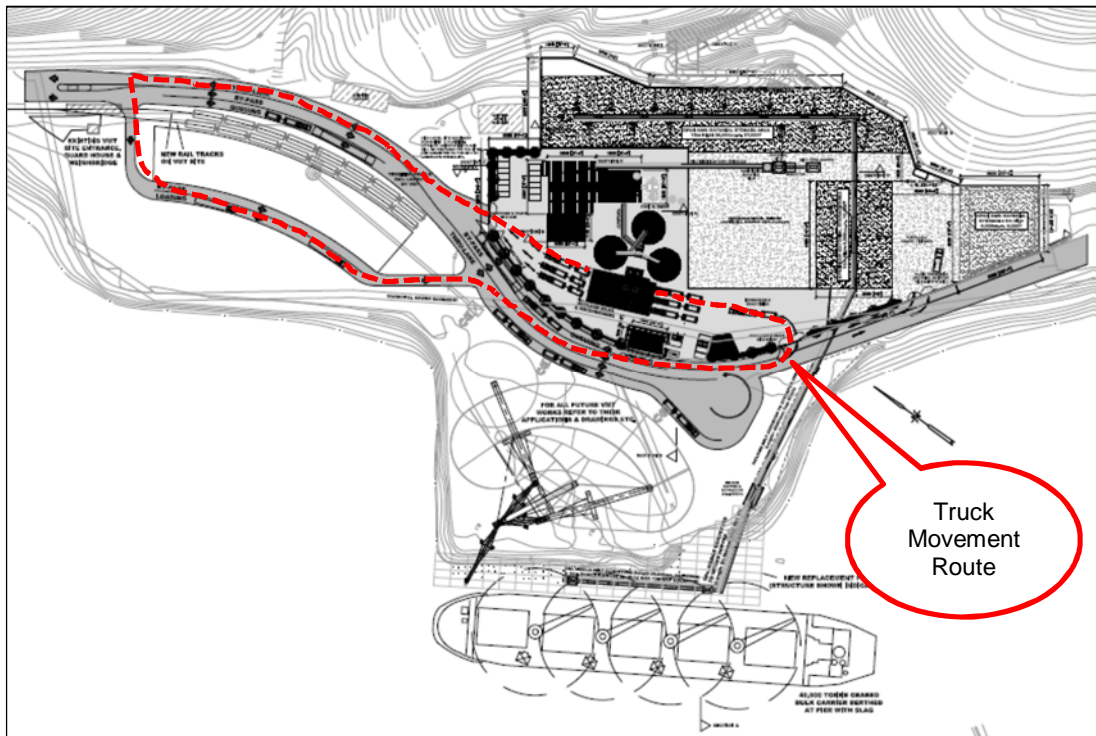

Figure 8 Orcem Rail Loading Operation

Table 21 lists the predicted hourly L_{Aeq} values for this activity based on an equal distribution of the 66 trucks over a 9 hour period.

Location	L_{Aeq} , 1hr
NSL1	--
NSL2	40
NSL3	33
NSL4	--
NSL5	--
NSL6	--
NSL7	--
NSL8	--
NSL9	--
NSL10	--

Table 21 Noise Levels due to Orcem Rail Activity

Note that there is no noise impact at the majority of locations as the activity occurs at a considerable distance from the noise sensitive properties themselves.

The noise levels presented in Tables 20 and 21 are representative of the worst-case noise level that may occur over an hour long period. In order to present the results in terms of L_{dn} as per the other impact assessments the overall noise levels have been calculated making the following assumptions:

- A 17 car train is loaded over the course of 9 hours during daytime hours;
- 2 switches per hour are required between the rail yard outside the site boundary and the rail transloading area;

- When switches are not occurring the locomotive will not be idling within the rail yard area;
- A worst-case of 2 train movements during the daytime (i.e. 07:00am to 10:00pm) representing an arrival and departure, each 17 car train is assumed to have 1 locomotives, and;
- The same intensity of activity over any 24hour period is assumed for both Phase 1 and Phase 2.

Table 22 presents the calculated noise levels at each location based on these assumptions.

Location	Calculated Noise Level, dB		
	L _{day}	L _{night}	L _{dn}
NSL1	41	0	39
NSL2	46	0	44
NSL3	48	0	46
NSL4	48	0	46
NSL5	51	0	49
NSL6	50	0	48
NSL7	43	0	41
NSL8	41	0	39
NSL9	43	0	41
NSL10	50	0	47

Table 22 Noise Levels due to Orcem Rail Activity

Please note that the noise from locomotive warning horns has not been included in this assessment as it is considered to be a sound made in the interest of public safety. Such sounds are considered to be exempt from noise impact assessments as per the guidance contained within Chapter 16 of the City of Vallejo's Municipal Code regarding exceptions to the City's noise performance standards

8.6 Overall Orcem Noise Impact

When assessing the overall noise impact of the Orcem activity each noise source discussed in the previous sections must be added logarithmically to determine the cumulative noise impact. However, in assessing the overall impact it is important to note the following:

- The Orcem production facility will operate continuously in accordance with the hours of operation discussed in Section 8.2;
- Truck movements on the local road network will increase gradually as the facility's production increases. The results presented here are representative of the worst-case scenarios at peak production for Phases 1 and 2 respectively;
- During Phase 1 up to 13 ships per year are expected to serve the Orcem site, increasing to 19 at peak production in Phase 2. When docked it is expected to take approximately 3 days to unload using a conveyor system, and;
- The number of trains per annum serving the Orcem facility is likely to range from up to 36 trains in Phase 1 to a maximum of 100 trains per annum in Phase 2, however, in any given 24hour period a single train can arrive be loaded or unloaded and depart. Please note that as per the Transportation/Traffic Information Technical Studies Submission dated 28 January 2014, there will be no rail activity if the site is operating under mode 2, i.e. cement production.

In order to present as realistic an assessment as possible the following three scenarios have been assessed for both phases:

- A. Noise impact of Orcem production and truck movements on the local road network. This represents the normal operation of the Orcem facility when there is no ship unloading or rail activity;

Mitigation measures will be determined for Scenario A in order to control any identified noise impacts.

- B. Scenario A (including mitigation) plus the temporary noise impact of ship unloading to the Orcem site, and;
C. Scenario A (including mitigation) plus the temporary noise impact of rail activity to the Orcem site.

Each scenario is presented for each noise sensitive location in the following sections.

8.6.1 Scenario A

NSL	Phase	Mode	Orcem Plant, dB L _{dn}	Orcem Trucks, dB L _{dn}	Project Noise, dB L _{dn}	Existing Baseline dB L _{dn}	Total Noise Level dB L _{dn}	Increase in Noise Level, dB L _{dn}
1	1	1	52	n/a	52	55	57	2
		2	54	n/a	54		58	3
		3	54	n/a	54		58	3
	2	1	54	n/a	54		58	3
		2	54	n/a	54		58	3
		3	54	n/a	54		58	3
2	1	1	60	40	60	53	61	8
		2	63	42	63		63	10
		3	63	41	63		63	10
	2	1	66	42	66		66	13
		2	66	44	66		66	13
		3	66	43	66		66	13
3	1	1	60	38	60	52	61	9
		2	61	39	61		62	10
		3	61	38	61		62	10
	2	1	60	39	60		61	9
		2	60	41	60		61	9
		3	60	40	60		61	9
4	1	1	60	39	60	52	61	9
		2	61	41	61		62	10
		3	61	40	61		62	10
	2	1	60	41	60		61	9
		2	60	43	60		61	9
		3	60	42	60		61	9

Table 23 Total Noise Levels due to Orcem Activity – Scenario A

NSL	Phase	Mode	Orcem Plant, dB L _{dn}	Orcem Trucks, dB L _{dn}	Project Noise, dB L _{dn}	Existing Baseline dB L _{dn}	Total Noise Level dB L _{dn}	Increase in Noise Level, dB L _{dn}
5	1	1	47	50	52	52	55	3
		2	48	51	53		55	3
		3	48	50	52		55	3
	2	1	47	51	52		55	3
		2	47	53	54		56	4
		3	47	52	53		56	4
6	1	1	43	62	62	57	63	6
		2	44	64	64		65	8
		3	44	62	62		63	6
	2	1	43	64	64		65	8
		2	44	66	66		67	10
		3	44	64	64		65	8
7	1	1	42	57	57	63	64	1
		2	44	59	59		64	1
		3	44	58	58		64	1
	2	1	44	59	59		64	1
		2	45	61	61		65	2
		3	45	60	60		65	2
8	1	1	53	n/a	53	54*	57	3
		2	54	n/a	54		57	3
		3	54	n/a	54		57	3
	2	1	53	n/a	53		57	3
		2	53	n/a	53		57	3
		3	53	n/a	53		57	3
9	1	1	39	60	60	63	65	2
		2	40	61	61		65	2
		3	40	60	60		65	2
	2	1	41	61	61		65	2
		2	41	63	63		66	3
		3	41	61	61		65	2
10	1	1	48	n/a	48	52*	53	1
		2	49	n/a	49		54	2
		3	49	n/a	49		54	2
	2	1	47	n/a	47		53	1
		2	48	n/a	48		53	1
		3	48	n/a	48		53	1

Table 23 cont.. Total Noise Levels due to Orcem Activity – Scenario A

Note * The L_{dn} levels at these properties have been estimated based on the short term measurements taken. The estimate was arrived at by assuming a 7dB difference in L_{Aeq} level between day and night-time periods. This was derived from an analysis of the long-term unattended monitors used during the survey period.

Table 24 summarizes the noise impacts and identifies those locations where a significant increase in the existing ambient noise level may occur.

NSL	Predicted Increase in Noise	Comment	Mitigation Required
1	2 – 3dB	This is not considered to be a significant permanent increase in the noise level according to the CEQA checklist	No
2	8 – 13dB	This is a significant permanent increase in the noise level according to the CEQA checklist	Yes
3	9 – 10dB	This is a significant permanent increase in the noise level according to the CEQA checklist	Yes
4	9 – 10dB	This is a significant permanent increase in the noise level according to the CEQA checklist	Yes
5	3 – 4dB	This is not considered to be a significant permanent increase in the noise level according to the CEQA checklist	No
6	6 – 10dB	This is not considered to be a significant permanent increase in the noise level according to the CEQA checklist. Note this property is located in an area zoned for industry.	No
7	1 – 2dB	This is not considered to be a significant permanent increase in the noise level according to the CEQA checklist	No
8	3dB	This is not considered to be a significant permanent increase in the noise level according to the CEQA checklist	No
9	2 – 3dB	This is not considered to be a significant permanent increase in the noise level according to the CEQA checklist	No
10	1 – 2dB	This is not considered to be a significant permanent increase in the noise level according to the CEQA checklist	No

Table 24 Comparison of Noise Levels to CEQA Thresholds of Significance – Scenario A

Mitigation is required for three locations in Scenario A as follows:

- NSL2 (Seawitch Lane Residences);
- NSL3 (Harbor Park Apartments), and;
- NSL4 (Browning Way Residences).

On review of the predicted noise levels the dominant noise sources impacting on these locations are all related to the Orcem fixed plant. The individual sources contributing most to the overall noise impact of the fixed plant are:

- Orcem stack;
- clinker store bag filter fan (513-FN1);
- bag filter fan on intake hopper (521-FN1);
- bag filter fan on the intake silo (521-FN2);
- Air shock on intake silo (531-AB1);
- Main fan (561-FN1);
- Filter Building bag filter fan (591-FN1);
- Filter Building air slide fans (591-FA1, 591-FA2 & 591-FA3), and;
- silo fan (591-FN3).

Mitigation is to be considered for these noise sources as follows:

- In-line attenuator between the main fan (561-FN1) and the stack exhaust offering minimum insertion losses as per Table 25 below;
- Local screening to the Clinker Store bag filter fan (513-FN1) to reduce the noise level by 19dB;
- Local screening to the bag filter fan (521-FN1) to reduce the noise level by 18dB;
- Local screening to the air shock (531-AB1) to reduce the noise level by 9dB;
- Local screening to the main fan (561-FN1) to reduce the noise level by 9dB;
- Local screening to the bag filter fan on the intake Silo (521-FN2) to reduce the noise level by 8dB;

- Local screening to the air slide fans within the filter building (591-FA1, 591-FA2 & 591-FA3) to reduce the noise level by 7dB, and;
- Local screening to the other sources listed above to reduce the noise emission of each source 3dB.

Ref	Measured Static Insertion Loss Octave Band Centre Frequency (Hz) dB							
	63	125	250	500	1k	2k	4k	8k
Stack Attenuator	11	13	15	17	19	20	20	20

Table 25 Minimum Static Insertion Loss values (dB) for Stack Attenuator

The local screening required for other fans could be achieved by one or more of the following methods:

- Local noise barriers;
- Enclosures around individual plant items where no air supply is required;
- Louvred enclosures around plant items where air supply is required, and;
- Proprietary noise reduction offered by the supplier/manufacturer.

Table 26 presents the predicted noise levels with the mitigation measures discussed above implemented.

NSL	Phase	Mode	Orcem Plant, dB L _{dn}	Orcem Trucks, dB L _{dn}	Project Noise, dB L _{dn}	Existing Baseline dB L _{dn}	Total Noise Level dB L _{dn}	Increase in Noise Level, dB L _{dn}
1	1	1	45	n/a	45	55	55	0
		2	46	n/a	46		56	1
		3	46	n/a	46		56	1
	2	1	46	n/a	46		55	1
		2	45	n/a	45		55	0
		3	45	n/a	45		55	0
2	1	1	55	40	55	53	57	4
		2	55	42	55		57	4
		3	55	41	55		57	4
	2	1	55	42	55		57	4
		2	56	44	56		58	5
		3	56	43	56		58	5
3	1	1	51	38	51	52	55	3
		2	51	39	52		55	3
		3	51	38	52		55	3
	2	1	51	39	52		55	3
		2	52	41	52		55	3
		3	52	40	52		55	3

Table 26 Total Noise Levels due to Orcem Activity – Scenario A with mitigation

NSL	Phase	Mode	Orcem Plant, dB L _{dn}	Orcem Trucks, dB L _{dn}	Project Noise, dB L _{dn}	Existing Baseline dB L _{dn}	Total Noise Level dB L _{dn}	Increase in Noise Level, dB L _{dn}
4	1	1	52	39	52	52	55	3
		2	53	41	53		55	3
		3	53	40	53		55	3
	2	1	53	41	53		55	3
		2	53	43	53		56	4
		3	53	42	53		56	4
5	1	1	41	50	50	52	54	2
		2	42	51	52		55	3
		3	42	50	51		54	2
	2	1	42	51	52		55	3
		2	42	53	53		56	4
		3	42	52	52		55	3
6	1	1	37	62	62	57	63	6
		2	38	64	64		65	8
		3	38	62	62		63	6
	2	1	38	64	64		65	8
		2	39	66	66		67	10
		3	39	64	64		65	8
7	1	1	37	57	57	63	64	1
		2	38	59	59		64	1
		3	38	58	58		64	1
	2	1	38	59	59		64	1
		2	39	61	61		65	2
		3	39	60	60		65	2
8	1	1	48	n/a	48	54*	55	1
		2	48	n/a	48		55	1
		3	48	n/a	48		55	1
	2	1	48	n/a	48		55	1
		2	49	n/a	49		55	1
		3	49	n/a	49		55	1
9	1	1	33	60	60	63	65	2
		2	35	61	61		65	2
		3	35	60	60		65	2
	2	1	35	61	61		65	2
		2	35	63	63		66	3
		3	35	61	61		65	2
10	1	1	38	n/a	38	52*	52	0
		2	40	n/a	40		52	0
		3	40	n/a	40		52	0
	2	1	40	n/a	40		52	0
		2	40	n/a	40		52	0
		3	40	n/a	40		52	0

Table 26 cont.. Total Noise Levels due to Orcem Activity – Scenario A with mitigation

Note * The L_{dn} levels at these properties have been estimated based on the short term measurements taken. The estimate was arrived at by assuming a 7dB difference in L_{Aeq} level between day and night-time periods. This was derived from an analysis of the long-term unattended monitors used during the survey period.

Table 27 summarizes the noise impacts and identifies those locations where a significant increase in the existing ambient noise level may occur.

NSL	Predicted Increase in Noise	Comment	Mitigation Required
1	0 – 1dB	This is not considered to be a significant permanent increase in the noise level according to the CEQA checklist	No
2	4 – 5dB	This is not considered to be a significant permanent increase in the noise level according to the CEQA checklist	No
3	3dB	This is not considered to be a significant permanent increase in the noise level according to the CEQA checklist	No
4	3 – 4dB	This is not considered to be a significant permanent increase in the noise level according to the CEQA checklist	No
5	2 – 4dB	This is not considered to be a significant permanent increase in the noise level according to the CEQA checklist	No
6	6 – 10dB	This is not considered to be a significant permanent increase in the noise level according to the CEQA checklist. Note this property is located in an area zoned for industry.	No
7	1 – 2dB	This is not considered to be a significant permanent increase in the noise level according to the CEQA checklist	No
8	1dB	This is not considered to be a significant permanent increase in the noise level according to the CEQA checklist	No
9	2 – 3dB	This is not considered to be a significant permanent increase in the noise level according to the CEQA checklist	No
10	0dB	This is not considered to be a significant permanent increase in the noise level according to the CEQA checklist	No

Table 27 Comparison of Noise Levels to CEQA Thresholds of Significance – Scenario A with mitigation

For Scenario A, which represents the typical day to day activity at the Orcem facility, the proposed mitigation measures have reduced the noise levels to ensure that there is no permanent and significant increase in the existing ambient noise levels.

8.6.2 Scenario B

Scenario B represents the situation where the Scenario A operation, with mitigation, is supplemented by ship unloading activity. While the frequency of ship unloading activity will increase as the output of the Orcem manufacturing facility increases, the intensity of the activity will be similar for all phases. Once a ship is at dock the material will be unloaded by conveyor operating continuously for 2 – 3 days. Therefore, the noise level due to ship unloading at a noise sensitive location is the same for each mode and phase. Table 28 presents the results for Scenario B.

NSL	Phase	Mode	Scenario A, dB L _{dn}	Ship Unloading, dB L _{dn}	Project Noise, dB L _{dn}	Existing Baseline dB L _{dn}	Total Noise Level dB L _{dn}	Increase in Noise Level, dB L _{dn}
1	1	1	45	46	49	55	56	1
		2	46	46	49		56	1
		3	46	46	49		56	1
	2	1	46	46	49		56	1
		2	45	46	49		56	1
		3	45	46	49		56	1
2	1	1	55	50	56	53	58	5
		2	55	50	56		58	5
		3	55	50	56		58	5
	2	1	55	50	56		58	5
		2	56	50	57		59	6
		3	56	50	57		59	6
3	1	1	51	40	51	52	55	3
		2	52	40	52		55	3
		3	52	40	52		55	3
	2	1	52	40	52		55	3
		2	52	40	53		55	3
		3	52	40	53		55	3
4	1	1	52	44	52	52	55	3
		2	53	44	53		56	4
		3	53	44	53		56	4
	2	1	53	44	53		56	4
		2	53	44	54		56	4
		3	53	44	54		56	4
5	1	1	50	39	51	52	54	2
		2	52	39	52		55	3
		3	51	39	51		55	3
	2	1	52	39	52		55	3
		2	53	39	54		56	4
		3	52	39	53		55	3
6	1	1	62	32	62	57	63	6
		2	64	32	64		65	8
		3	62	32	62		63	6
	2	1	64	32	64		65	8
		2	66	32	66		67	10
		3	64	32	64		65	8

Table 28 Total Noise Levels due to Orcem Activity – Scenario B

NSL	Phase	Mode	Scenario A, dB L _{dn}	Ship Unloading, dB L _{dn}	Project Noise, dB L _{dn}	Existing Baseline dB L _{dn}	Total Noise Level dB L _{dn}	Increase in Noise Level, dB L _{dn}
7	1	1	57	28	57	63	64	1
		2	59	28	59		64	1
		3	58	28	58		64	1
	2	1	59	28	59		64	1
		2	61	28	61		65	2
		3	60	28	60		65	2
8	1	1	48	49	51	54*	56	2
		2	48	49	52		56	2
		3	48	49	52		56	2
	2	1	48	49	52		56	2
		2	49	49	52		56	2
		3	49	49	52		56	2
9	1	1	60	29	60	63	65	2
		2	61	29	61		65	2
		3	60	29	60		65	2
	2	1	61	29	61		65	2
		2	63	29	63		66	3
		3	61	29	61		65	2
10	1	1	38	39	42	52*	52	0
		2	40	39	42		52	0
		3	40	39	42		52	0
	2	1	40	39	42		52	0
		2	40	39	43		52	0
		3	40	39	43		52	0

Table 28 cont.. Total Noise Levels due to Orcem Activity – Scenario B

Note * The L_{dn} levels at these properties have been estimated based on the short term measurements taken. The estimate was arrived at by assuming a 7dB difference in L_{Aeq} level between day and night-time periods. This was derived from an analysis of the long-term unattended monitors used during the survey period.

Table 29 summarizes the noise impacts and identifies those locations where a significant increase in the existing ambient noise level may occur for Scenario B.

NSL	Predicted Increase in Noise	Comment	Mitigation Required
1	1dB	This is not considered to be a significant permanent increase in the noise level according to the CEQA checklist	No
2	5 – 6dB	This is a significant temporary increase in the noise level according to the CEQA checklist	See Discussion
3	3dB	This is not considered to be a significant permanent increase in the noise level according to the CEQA checklist	No
4	3 – 4dB	This is not considered to be a significant permanent increase in the noise level according to the CEQA checklist	No
5	2 – 4dB	This is not considered to be a significant permanent increase in the noise level according to the CEQA checklist	No
6	6 – 10dB	This is not considered to be a significant permanent increase in the noise level according to the CEQA checklist. Note this property is located in an area zoned for industry.	No
7	1 – 2dB	This is not considered to be a significant permanent increase in the noise level according to the CEQA checklist	No
8	2dB	This is not considered to be a significant permanent increase in the noise level according to the CEQA checklist	No

NSL	Predicted Increase in Noise	Comment	Mitigation Required
9	2 – 3dB	This is not considered to be a significant permanent increase in the noise level according to the CEQA checklist	No
10	0dB	This is not considered to be a significant permanent increase in the noise level according to the CEQA checklist	No

Table 29 Comparison of Noise Levels to CEQA Thresholds of Significance – Scenario B

The majority of locations show no change in the noise level for this scenario when compared to Scenario A with mitigation. However, during phase 2 of the development there is a slight exceedance of 1dB above the allowed increase above ambient of 5dB. This increase is insignificant and would not be noticeable. Furthermore, considering the temporary nature of the activity, once a month in Phase 1 and up to once every three weeks in Phase 2, it is not considered necessary to provide mitigation in this instance.

8.6.2 Scenario C

Scenario C represents the situation where the Scenario A operation, with mitigation, is supplemented by train loading/unloading activity. While the frequency of train activity will increase as the output of the Orcem manufacturing facility increases, the intensity of the activity will be similar for all phases. A maximum of one train movement to and from the site during any single 24 hour period is representative of the worst-case for all phases and modes. Table 30 presents the results for Scenario C. Note that there is no train activity during mode 2 operations (i.e. cement production).

NSL	Phase	Mode	Scenario A, dB L _{dn}	Train Loading, dB L _{dn}	Project Noise, dB L _{dn}	Existing Baseline dB L _{dn}	Total Noise Level dB L _{dn}	Increase in Noise Level, dB L _{dn}
1	1	1	45	39	46	55	56	1
		2	46	0	46		56	1
		3	46	39	47		56	1
	2	1	46	39	47		56	1
		2	45	0	45		55	0
		3	45	39	46		56	1
2	1	1	55	44	55	53	57	4
		2	55	0	55		57	4
		3	55	44	55		57	4
	2	1	55	44	55		57	4
		2	56	0	56		58	5
		3	56	44	56		58	5

Table 30 Total Noise Levels due to Orcem Activity – Scenario C

NSL	Phase	Mode	Scenario A, dB L _{dn}	Train Loading, dB L _{dn}	Project Noise, dB L _{dn}	Existing Baseline dB L _{dn}	Total Noise Level dB L _{dn}	Increase in Noise Level, dB L _{dn}
3	1	1	51	46	52	52	55	3
		2	52	0	52		55	3
		3	52	46	53		55	3
	2	1	52	46	53		55	3
		2	52	0	52		55	3
		3	52	46	53		56	4
4	1	1	52	46	53	52	55	3
		2	53	0	53		55	3
		3	53	46	54		56	4
	2	1	53	46	54		56	4
		2	53	0	53		56	4
		3	53	46	54		56	4
5	1	1	50	49	53	52	55	3
		2	52	0	52		55	3
		3	51	49	53		55	3
	2	1	52	49	53		56	4
		2	53	0	53		56	4
		3	52	49	54		56	4
6	1	1	62	48	62	57	63	6
		2	64	0	64		65	8
		3	62	48	62		63	6
	2	1	64	48	64		65	8
		2	66	0	66		67	10
		3	64	48	64		65	8
7	1	1	57	41	57	63	64	1
		2	59	0	59		64	1
		3	58	41	58		64	1
	2	1	59	41	59		64	1
		2	61	0	61		65	2
		3	60	41	60		65	2
8	1	1	48	39	48	54*	55	1
		2	48	0	48		55	1
		3	48	39	49		55	1
	2	1	48	39	49		55	1
		2	49	0	49		55	1
		3	49	39	49		55	1

Table 30 cont.. Total Noise Levels due to Orcem Activity – Scenario C

NSL	Phase	Mode	Scenario A, dB L _{dn}	Train Loading, dB L _{dn}	Project Noise, dB L _{dn}	Existing Baseline dB L _{dn}	Total Noise Level dB L _{dn}	Increase in Noise Level, dB L _{dn}
9	1	1	60	41	60	63	65	2
		2	61	0	61		65	2
		3	60	41	60		65	2
	2	1	61	41	61		65	2
		2	63	0	63		66	3
		3	61	41	61		65	2
10	1	1	38	47	48	52*	53	1
		2	40	0	40		52	0
		3	40	47	48		54	2
	2	1	40	47	48		54	2
		2	40	0	40		52	0
		3	40	47	48		54	2

Table 30 cont.. Total Noise Levels due to Orcem Activity – Scenario C

Note * The L_{dn} levels at these properties have been estimated based on the short term measurements taken. The estimate was arrived at by assuming a 7dB difference in L_{Aeq} level between day and night-time periods. This was derived from an analysis of the long-term unattended monitors used during the survey period.

Table 29 summarizes the noise impacts and identifies those locations where a significant increase in the existing ambient noise level may occur for Scenario B.

NSL	Predicted Increase in Noise	Comment	Mitigation Required
1	0 – 1dB	This is not considered to be a significant permanent increase in the noise level according to the CEQA checklist	No
2	4 – 5dB	This is not considered to be a significant permanent increase in the noise level according to the CEQA checklist	No
3	3 – 4dB	This is not considered to be a significant permanent increase in the noise level according to the CEQA checklist	No
4	3 – 4dB	This is not considered to be a significant permanent increase in the noise level according to the CEQA checklist	No
5	3 – 4dB	This is not considered to be a significant permanent increase in the noise level according to the CEQA checklist	No
6	6 – 10dB	This is not considered to be a significant permanent increase in the noise level according to the CEQA checklist. Note this property is located in an area zoned for industry.	No
7	1 – 2dB	This is not considered to be a significant permanent increase in the noise level according to the CEQA checklist	No
8	1dB	This is not considered to be a significant permanent increase in the noise level according to the CEQA checklist	No
9	2 – 3dB	This is not considered to be a significant permanent increase in the noise level according to the CEQA checklist	No
10	0 – 2dB	This is not considered to be a significant permanent increase in the noise level according to the CEQA checklist	No

Table 29 Comparison of Noise Levels to CEQA Thresholds of Significance – Scenario B

None of the assessed locations show a change in the noise level for this scenario when compared to Scenario A with mitigation. Therefore, there is no significant noise impact as a result of rail activity to the Orcem site and no further mitigation is required.

8.7 Operational Vibration

During the operational phase of the development the Orcem facility is not expected to generate any significant groundborne vibrations as a result of its operation. All mechanical plant will be designed and mounted so as to reduce vibrations. This will form part of the sites general maintenance programme as excessive vibrations are likely to increase the likelihood of mechanical failure.

In relation to truck movements on the local road network there is potential for some groundborne vibrations to be generated by discontinuities in the road surface. However, by ensuring that the road surface is smooth and well maintained the potential for these vibrations is significantly reduced.

In summary, there is not expected to be any significant groundborne vibration generated as a result of the operation of the Orcem facility..

9.0 CONCLUSION

The potential noise impact of the proposed Orcem manufacturing facility has been assessed. The noise impact assessment was carried out for both the construction and operational phases of the development.

For the operational phase the noise impact has been determined through a comparison of the predicted project noise levels against the existing ambient noise levels determined through a baseline survey. For residentially zoned lands in the vicinity a significant noise impact has been identified for areas where the project related noise causes a greater than 5dB increase above the existing ambient or a greater than 3dB increase in areas where the with project noise level exceeds the normally acceptable noise level proposed in the Vallejo General Plan. In addition, for locations within non-residentially zoned lands a significant noise impact is defined as a greater than 10dB increase above the existing ambient.

The construction phase of the project has been assessed using the calculation methodology detailed in the Roadway Construction Noise Model (RCNM) developed by the Federal Highway Administration (FHWA). It has been found that the construction activity has the potential to generate a substantial temporary increase in ambient noise levels in the vicinity of the project. However, implementation of the following multi-part mitigation measure would reduce potential construction period noise impacts.

- All construction equipment must have appropriate sound muffling devices, which shall be properly maintained and used at all times such equipment is in operation.
- Where feasible, the project contractor shall place all stationary construction equipment so that emitted noise is directed away from sensitive receptors nearest the project site.
- The construction contractor shall locate on-site equipment staging areas so as to maximize the distance between construction-related noise sources and noise-sensitive receptors nearest the project site.
- Except as otherwise permitted, construction activities shall be restricted to the hours of 7:00 a.m. to 9:00 p.m. daily.

Construction vibration is not expected to generate any significant impact due to the distance between the construction activity and the nearest properties.

The results of the operational phase assessment have found that there is a potentially significant and permanent noise increase at some properties as a result of the Orcem facilities fixed plant operation. In order to reduce the noise impact of the plant operation a series of mitigation measures have been proposed to specific items of plant as follows:

- In-line attenuator between the main fan (561-FN1) and the stack exhaust offering minimum insertion losses as per Table 25 in this report;
- Local screening to the Clinker Store bag filter fan (513-FN1) to reduce the noise level by 19dB;
- Local screening to the bag filter fan (521-FN1) to reduce the noise level by 18dB;
- Local screening to the air shock (531-AB1) to reduce the noise level by 9dB;
- Local screening to the main fan (561-FN1) to reduce the noise level by 9dB;
- Local screening to the bag filter fan on the intake Silo (521-FN2) to reduce the noise level by 8dB;
- Local screening to the air slide fans within the filter building (591-FA1, 591-FA2 & 591-FA3) to reduce the noise level by 7dB, and;
- Local screening to the Filter Building bag filter fan (591-FN1) and the silo fan (591-FN3) to reduce the noise emission of each source 3dB.

With these measures in place the noise impact of the regular operation of the Orcem plant is not significant. In addition, to the normal operation of the plant the additional noise impact of the temporary and infrequent ship unloading and rail loading activities have also been assessed. It has been found that neither of these operations will generate an additional noise impact that is classified as significant and therefore no specific mitigation measures are required for these activities.

No source of vibration is expected during the operational phase.

In conclusion, with appropriate noise mitigation measures the proposed Orcem facility can operate without generating a significant and permanent noise impact on the surrounding environment.

APPENDIX A

Glossary of Acoustic Terminology

Term	Description
dB	'Decibel' – Used as a measurement of sound pressure level. It is the logarithmic ratio of the noise being assessed to a standard reference level.
dB(A)	'A-Weighted Decibel' – The human ear is more susceptible to mid-frequency noise than the high and low frequencies. To take account of this when measuring noise, the 'A' weighting scale is used so that the measured noise corresponds roughly to the overall level of noise that is discerned by the average human. Because of being a logarithmic scale noise levels in dB(A) do not have a linear relationship to each other. For similar noises, a change in noise level of 10dB(A) represents a doubling or halving of subjective loudness. A change of 3dB(A) is just perceptible.
$L_{Aeq,T}$	The level of notional steady sound which, over a stated period of time, would have the same A-weighted acoustic energy as the A-weighted fluctuating noise measured over that period. This parameter is indicative of the "average" noise level occurring over the sample period (T).
$L_{A1,T}$	This is the sound level that is exceeded for 1% of the sample period. It is typically used as a descriptor for infrequent loud noise events of short duration, e.g. truck pass-bys.
$L_{A10,T}$	This is the sound level that is exceeded for 10% of the sample period. It is typically used as a descriptor for traffic noise.
$L_{A50,T}$	This is the sound level that is exceeded for 50% of the sample period.
$L_{A90,T}$	This is the sound level that is exceeded for 90% of the sample period. It is typically used as a descriptor for background noise.
L_{AMax}	This is the maximum sound level that is exceeded during the sample period.
L_{WA}	The A-weighted sound power level. Unlike sound pressure, sound power is neither room dependent nor distance dependent. Sound power belongs strictly to the sound source. Sound pressure is a measurement at a point in space near the source, while sound power is the total power produced by the source in all directions.
$L_{eq(24hr)}$	The average noise level over 24hours based on the A-weighted L_{eq} noise levels
L_{dn}	The day-night average noise level is a weighted average based on the A-weighted noise levels during the daytime (07:00hrs to 22:00hrs) and night-time (22:00hrs to 07:00hrs) with a 10dB weighting applied during the night-time period.
CNEL	The Community Noise Equivalent Level is a weighted average based on the A-weighted noise levels during the daytime (07:00hrs to 19:00hrs), evening time (19:00hrs and 22:00hrs) and night-time (22:00hrs to 07:00hrs) with a 5dB weighting applied during the evening time and a 10dB weighting applied during the night-time period.

The "A" suffix denotes the fact that the sound levels have been "A-weighted" in order to account for the non-linear nature of human hearing. All sound levels in this report are expressed in terms of decibels (dB) relative to 2×10^{-5} Pa. T is the sample period for noise measurement.

APPENDIX B
Baseline Noise Report

***ORCEM VALLEJO GGBFS PLANT
NOISE BASELINE CONDITIONS REPORT
VALLEJO, CALIFORNIA***

October 10, 2013



Prepared for:

**Dr. Stephen Smyth
Senior Acoustic Consultant
AWN Consulting
The Tecpro Building
IDA Business & Technology Park
Clonshaugh
Dublin 17**

Prepared by:

Michael S. Thill

ILLINGWORTH & RODKIN, INC.
Acoustics · Air Quality
**1 Willowbrook Court, Suite 120
Petaluma, CA 94954
(707) 794-0400**

Introduction

This report presents background information on the existing noise environment in the vicinity of the Orcem Vallejo GGBFS Plant site located in Vallejo, California. The purpose of the report is to present and characterize the sources of ambient noise and the different noise settings near the project site. This background information will serve as the basis for completing the first and fundamental step in analyzing potential noise impacts attributable to the project.

This section has been organized to provide information on the fundamentals of environmental noise and vibration, definitions of technical terms to assist the reader in understanding these issues and the City's current noise guidelines, and a summary of the results of the noise monitoring survey.

Fundamentals of Environmental Noise

Noise is defined as unwanted sound. Airborne sound is a rapid fluctuation of air pressure above and below atmospheric pressure. Sound levels are usually measured and expressed in decibels (dB) with 0 dB corresponding roughly to the threshold of hearing. Decibels and other technical terms are defined in Table 1.

Most of the sounds that we hear in the environment do not consist of a single frequency, but rather a broad band of frequencies, with each frequency differing in sound level. The intensities of each frequency add together to generate a sound. The method commonly used to quantify environmental sounds consists of evaluating all of the frequencies of a sound in accordance with a weighting that reflects the facts that human hearing is less sensitive at low frequencies and extreme high frequencies than in the frequency mid-range. This is called "A" weighting, and the decibel level so measured is called the A-weighted sound level (dBA). In practice, the level of a sound source is conveniently measured using a sound level meter that includes an electrical filter corresponding to the A-weighting curve. Typical A-weighted levels measured in the environment and in industry are shown in Table 2 for different types of noise.

Although the A-weighted noise level may adequately indicate the level of environmental noise at any instant in time, community noise levels vary continuously. Most environmental noise includes a conglomeration of noise from distant sources that create a relatively steady background noise in which no particular source is identifiable. To describe the time-varying character of environmental noise, the statistical noise descriptors, L_{01} , L_{10} , L_{50} , and L_{90} , are commonly used. They are the A-weighted noise levels equaled or exceeded during 1%, 10%, 50%, and 90% of a stated time period. A single number descriptor called the L_{eq} is also widely used. The L_{eq} is the average A-weighted noise level during a stated period of time.

In determining the daily level of environmental noise, it is important to account for the difference in response of people to daytime and nighttime noises. During the nighttime, exterior background noises are generally lower than the daytime levels. However, most household noise also decreases at night and exterior noise becomes very noticeable. Further, most people sleep at

night and are very sensitive to noise intrusion. To account for human sensitivity to nighttime noise levels, a descriptor, L_{dn} (day/night average sound level), was developed. The L_{dn} divides the 24-hour day into the daytime of 7:00 AM to 10:00 PM and the nighttime of 10:00 PM to 7:00 AM. The nighttime noise level is weighted 10 dB higher than the daytime noise level. The Community Noise Equivalent Level (CNEL) is another 24-hour average that includes both an evening and nighttime weighting.

Fundamentals of Groundborne Vibration

Ground vibration consists of rapidly fluctuating motions or waves with an average motion of zero. Several methods are typically used to quantify the amplitude of vibration including Peak Particle Velocity (PPV) and Root Mean Square (RMS) velocity. PPV is defined as the maximum instantaneous positive or negative peak of the vibration wave. RMS velocity is defined as the average of the squared amplitude of the signal, usually measured in decibels referenced to 1micro-in/sec and reported in VdB. PPV and VdB vibration velocity amplitudes are used to evaluate human response to vibration.

Low-level vibrations frequently cause irritating secondary vibration, such as a slight rattling of windows, doors or stacked dishes. The rattling sound can give rise to exaggerated vibration complaints, even though there is very little risk of actual structural damage. In high noise environments, which are more prevalent where ground-borne vibration approaches perceptible levels, this rattling phenomenon may also be produced by loud airborne environmental noise causing induced vibration in exterior doors and windows.

In urban environments, sources of ground-borne vibration include construction activities, light and heavy rail transit, and heavy trucks and buses.

Construction Vibration

Construction activities can cause vibration that varies in intensity depending on several factors. The use of pile driving and vibratory compaction equipment typically generates the highest construction related ground-borne vibration levels. Because of the impulsive nature of such activities, the use of the peak particle velocity descriptor (PPV) has been routinely used to measure and assess ground-borne vibration and almost exclusively to assess the potential of vibration to induce structural damage and the degree of annoyance for humans.

The two primary concerns with construction-induced vibration, the potential to damage a structure and the potential to interfere with the enjoyment of life are evaluated against different vibration limits. Studies have shown that the threshold of perception for average persons is in the range of 0.008 to 0.012 in/sec, PPV. Human perception to vibration varies with the individual and is a function of physical setting and the type of vibration. Persons exposed to elevated ambient vibration levels such as people in an urban environment may tolerate a higher vibration level.

Structural damage can be classified as cosmetic only, such as minor cracking of building elements, or may threaten the integrity of the building. Safe vibration limits that can be applied to assess the potential for damaging a structure vary by researcher and there is no general consensus as to what amount of vibration may pose a threat for structural damage to the building. Construction-induced vibration that can be detrimental to a building is very rare and has only been observed in instances where the structure is at a high state of disrepair and the construction activity (e.g., impact pile driving) occurs immediately adjacent to the structure.

Table 3 displays continuous vibration impacts on human annoyance and on buildings. As discussed previously, annoyance is a subjective measure and vibrations may be found to be annoying at much lower levels than those shown, depending on the level of activity or the sensitivity of the individual. To sensitive individuals, vibrations approaching the threshold of perception can be annoying.

Rail Vibration

Rail operations are potential sources of substantial ground-borne vibration depending on distance, the type and the speed of trains, and the type of railroad track. People's response to ground-borne vibration has been correlated best with the velocity of the ground. The velocity of the ground is expressed on the decibel scale. The reference velocity is 1×10^{-6} in. /sec. RMS, which equals 0 VdB, and 1 in. /sec. equals 120 VdB. Although not a universally accepted notation, the abbreviation "VdB" is used in this document for vibration decibels to reduce the potential for confusion with sound decibels.

One of the problems with developing suitable criteria for ground-borne vibration is the limited research into human response to vibration and more importantly human annoyance inside buildings. The U.S. Department of Transportation, Federal Transit Administration has developed rational vibration limits that can be used to evaluate human annoyance to ground-borne vibration. These limits are summarized in Table 4. These criteria are primarily based on experience with passenger train operations, such as rapid transit and commuter rail systems. The main difference between passenger and freight operations is the time duration of individual events; a passenger train lasts a few seconds whereas a long freight train may last several minutes, depending on speed and length.

Vibration from Heavy Trucks and Buses

Ground-borne vibration levels from heavy trucks and buses are not normally perceptible, especially if roadway surfaces are smooth. Buses and trucks typically generate ground-borne vibration levels of about 63 VdB at a distance of 25 feet when traveling at a speed of 30 mph. Higher vibration levels can occur when buses or trucks travel at higher rates of speed or when the pavement is in poor condition. Vibration levels below 65 VdB are below the threshold for human perception.

Table 1: Definitions of Acoustical Terms Used in this Report

Term	Definitions
Decibel, dB	A unit describing, the amplitude of sound, equal to 20 times the logarithm to the base 10 of the ratio of the pressure of the sound measured to the reference pressure. The reference pressure for air is 20.
Sound Pressure Level	Sound pressure is the sound force per unit area, usually expressed in micro Pascals (or 20 micro Newtons per square meter), where 1 Pascal is the pressure resulting from a force of 1 Newton exerted over an area of 1 square meter. The sound pressure level is expressed in decibels as 20 times the logarithm to the base 10 of the ratio between the pressures exerted by the sound to a reference sound pressure (e.g., 20 micro Pascals). Sound pressure level is the quantity that is directly measured by a sound level meter.
Frequency, Hz	The number of complete pressure fluctuations per second above and below atmospheric pressure. Normal human hearing is between 20 Hz and 20,000 Hz. Infrasonic sound are below 20 Hz and Ultrasonic sounds are above 20,000 Hz.
A-Weighted Sound Level, dBA	The sound pressure level in decibels as measured on a sound level meter using the A-weighting filter network. The A-weighting filter de-emphasizes the very low and very high frequency components of the sound in a manner similar to the frequency response of the human ear and correlates well with subjective reactions to noise.
Equivalent Noise Level, Leq	The average A-weighted noise level during the measurement period.
L_{max} , L_{min}	The maximum and minimum A-weighted noise level during the measurement period.
L_{01} , L_{10} , L_{50} , L_{90}	The A-weighted noise levels that are exceeded 1%, 10%, 50%, and 90% of the time during the measurement period.
Day/Night Noise Level, L_{dn} or DNL	The average A-weighted noise level during a 24-hour day, obtained after addition of 10 decibels to levels measured in the night between 10:00 pm and 7:00 am.
Community Noise Equivalent Level, CNEL	The average A-weighted noise level during a 24-hour day, obtained after addition of 5 decibels in the evening from 7:00 pm to 10:00 pm and after addition of 10 decibels to sound levels measured in the night between 10:00 pm and 7:00 am.
Ambient Noise Level	The composite of noise from all sources near and far. The normal or existing level of environmental noise at a given location.
Intrusive	That noise which intrudes over and above the existing ambient noise at a given location. The relative intrusiveness of a sound depends upon its amplitude, duration, frequency, and time of occurrence and tonal or informational content as well as the prevailing ambient noise level.

Source: Handbook of Acoustical Measurements and Noise Control, Harris, 1998.

Table 2: Typical Noise Levels in the Environment

Common Outdoor Activities	Noise Level (dBA)	Common Indoor Activities
	110 dBA	Rock band
Jet fly-over at 1,000 feet		
	100 dBA	
Gas lawn mower at 3 feet		
	90 dBA	
Diesel truck at 50 feet at 50 mph		Food blender at 3 feet
	80 dBA	Garbage disposal at 3 feet
Noisy urban area, daytime		
Gas lawn mower, 100 feet	70 dBA	Vacuum cleaner at 10 feet
Commercial area		Normal speech at 3 feet
Heavy traffic at 300 feet	60 dBA	
		Large business office
Quiet urban daytime	50 dBA	Dishwasher in next room
Quiet urban nighttime	40 dBA	Theater, large conference room
Quiet suburban nighttime		
	30 dBA	Library
Quiet rural nighttime		Bedroom at night, concert hall
	20 dBA	
	10 dBA	Broadcast/recording studio
	0 dBA	

Source: Technical Noise Supplement (TeNS), Caltrans, November 2009.

Table 3: Reaction of People and Damage to Buildings From Continuous or Frequent Intermittent Vibration Levels

Velocity Level, PPV (in/sec)	Human Reaction	Effect on Buildings
0.01	Barely perceptible	No effect
0.04	Distinctly perceptible	Vibration unlikely to cause damage of any type to any structure
0.08	Distinctly perceptible to strongly perceptible	Recommended upper level of the vibration to which ruins and ancient monuments should be subjected
0.1	Strongly perceptible	Virtually no risk of damage to normal buildings
0.3	Strongly perceptible to severe	Threshold at which there is a risk of damage to older residential dwellings such as plastered walls or ceilings
0.5	Severe - Vibrations considered unpleasant	Threshold at which there is a risk of damage to newer residential structures

Source: Transportation- and Construction-Induced Vibration Guidance Manual, California Department of Transportation, June 2004.

Table 4: FTA Groundborne Vibration Impact Criteria

Land Use Category	Impact Levels (VdB re 1 micro-inch /sec)		
	Frequent Events¹	Occasional Events²	Infrequent Events³
Category 1: Buildings where vibration would interfere with interior operations.	65 VdB ⁴	65 VdB ⁴	65 VdB ⁴
Category 2: Residences and buildings where people normally sleep.	72 VdB	75 VdB	80 VdB
Category 3: Institutional land uses with primarily daytime use.	75 VdB	78 VdB	83 VdB

Notes:

1. "Frequent Events" is defined as more than 70 vibration events per day. Most rapid transit projects fall into this category.
2. "Occasional Events" is defined as between 30 and 70 vibration events of the same source per day. Most commuter trunk lines have this many operations.
3. "Infrequent Events" is defined as fewer than 30 vibration events per day. This category includes most commuter rail systems.
4. This limit is based on levels that are acceptable for most moderately sensitive equipment such as optical microscopes.

Source: US Department of Transportation Federal Transit Administration 2006

Regulatory Background

The State of California and the City of Vallejo establish guidelines, regulations, and policies designed to limit noise exposure at noise sensitive land uses. Appendix G of the State CEQA Guidelines, the City of Vallejo Noise Element of the General Plan, and the City of Vallejo Municipal Code present the following:

State CEQA Guidelines. The California Environmental Quality Act (CEQA) contains guidelines to evaluate the significance of effects of environmental noise attributable to a proposed project. CEQA asks the following applicable questions. Would the project:

- a. Expose people to or generate noise levels in excess of standards established in the local general plan, noise ordinance, or applicable standards of other agencies;
- b. Expose people to or generate excessive groundborne vibration or groundborne noise levels;
- c. Result in a substantial permanent increase in ambient noise levels in the project vicinity above levels existing without the project;
- d. Result in a substantial temporary or periodic increase in ambient noise levels in the project vicinity above levels existing without the project;
- e. For projects within an area covered by an airport land use plan or within two miles of a public airport or public use airport when such an airport land use plan has not been adopted, or within the vicinity of a private airstrip, expose people residing or working in the project area to excessive aircraft noise levels;
- f. For a project within the vicinity of a private airstrip, expose people residing or working in the project area to excessive noise levels?

CEQA does not define the noise level increase that is considered substantial. Typically, an increase in the day-night average noise level of 3 dBA L_{dn} or greater at noise-sensitive receptors would be considered significant when projected noise levels would exceed those considered satisfactory for the affected land use. An increase of 5 dBA L_{dn} or greater would be considered significant when projected noise levels would continue to meet those considered satisfactory for the affected land use

City of Vallejo General Plan. The Vallejo General Plan establishes noise and land use compatibility guidelines for new development. In residential areas the maximum exterior noise level goal at primary outdoor use areas is 60 dBA L_{dn} . Noise levels up to of 65 dBA L_{dn} may be allowed at the discretion of the City where it is not economically or aesthetically reasonable to meet the more restrictive outdoor goal. The interior noise standard is 45 dBA L_{dn} for all residential uses, including single and multi-family housing, hotels/motels and residential healthcare facilities.

Policy 2b limits, where appropriate, noise generating activities (for example, construction and maintenance activities and loading and unloading activities) to the hours of 7:00 am to 9:00 pm.

The Noise Element also addresses “increase in the ambient” resulting from a proposed project. That is the amount by which a new project would cause noise levels in a community to increase above existing levels. When approving new development, project related noise increases shall be limited to 5 dBA in quiet residential areas and to no more than 3 dBA in residential areas where noise levels currently exceed 60 dBA L_{dn} .

City of Vallejo Noise Ordinance. The Vallejo Municipal Code establishes noise performance standards for noise sources and receptors in Vallejo. Section 7.84.010 generally prohibits loud unnecessary noises, but does not provide quantifiable noise level limits. Section 7.84.020 defines a “noise disturbance” as any sound which (1) endangers or injures the safety or health of humans or animals; (2) annoys or disturbs a reasonable person of normal sensitiveness; or (3) endangers or injures personal or real property. Section 12.40.070 addresses excavating, grading and filling related to construction: All grading and noise there from, including but not limited to, warming of equipment motors, in residential zones or within 1,000 feet of any residential occupancy, hotel, motel or hospital shall be limited to between the hours of 7:00 am to 6:00 pm.

Chapter 16.72 establishes noise performance standards for land use generated noise. When sound is received at a rural residence the maximum allowable level is 55 dBA. The maximum allowable level is 60 dBA L_{eq} ¹ at low, medium, and high density residential districts. Correction factors are applied for time of day that the noise is generated and the character of the noise. If noise is only generated during the daytime (7:00 am to 10:00 pm) the allowable limit would be raised 5 dBA to 65 dBA L_{eq} . If the noise source is impulsive such as hammering or screeching, the allowable level would be reduced 5 dBA. Sounds from transportation equipment used exclusively in the movement of goods and people to and from a given premises are exempted from the code.

Existing Noise Environment

An ambient noise monitoring survey was made between September 18, 2013 and September 25, 2013 to document existing noise conditions at or near noise-sensitive receptors (e.g., residences) adjoining the project site. The noise monitoring survey included five long-term measurements (LT-1 through LT-5) and four short-term measurements (ST-1 through ST-4). An overview of the project site, vicinity, and noise measurement locations are shown on Figure 1a. Figure 1b shows the locations of long-term noise measurement sites nearest the project site.

Noise levels were measured with Larson Davis Model 820 Integrating Sound Level Meters (SLMs) set at “slow” response. The Model 820 Sound Level Meters were equipped with G.R.A.S. Type 40AQ ½ - inch random incidence microphones. A windscreen was placed over the microphone during all measurements. The sound level measuring assemblies were calibrated

¹ Section 16.72.060 – Noise level measurement. D. Measured Sound Levels. The measurement of sound level limits shall be the average sound level for a period of one hour.

prior to each measurement using a Model CAL200 acoustical calibrator. The responses of the systems were checked after the measurement session and no calibration adjustments were made to the sound levels measured by the SLM. At the completion of the monitoring event, the measured interval noise level data were obtained from the SLM using the Larson Davis SLM utility software program. All instrumentation meets the requirements of the American National Standards Institute (ANSI) SI.4-1983 for Type 1 use. Meteorological conditions during the measurements were generally acceptable for noise monitoring, primarily consisting of clear to partly cloudy skies, calm to light winds, and seasonable temperatures. A brief storm was noted on Saturday, September 21, 2013, yielding higher ambient noise levels during periods of wind and precipitation.

The hourly trends in noise levels at LT-1 through LT-5 are shown on Figures 2 through 41. Included in each figure are the energy equivalent noise level ($L_{eq(hr)}$), the maximum instantaneous noise level (L_{max}), the minimum instantaneous noise level (L_{min}), and statistical noise levels (L_n - noise levels exceeded 1, 10, 50, and 90 percent of the time).

Site LT-1 was selected to represent the noise environment of Sandy Beach Road residential land uses located along the waterfront. The measurement site was approximately 1,200 feet (365 meters) northwest of Sandy Beach Road in an area of the project site considered acoustically equivalent to the Sandy Beach Road vicinity. Continuous noise measurements were made at Site LT-1 from about 1:00 p.m., September 18, 2013 to 12:00 p.m., September 25, 2013. The day-night average noise level calculated based on the measured data ranged from 51 to 59 dBA L_{dn} (excluding weather-affected data collected on Saturday, September 21, 2013) with an average L_{dn} of 55 dBA. These data are summarized on Figures 2-9.

Noise measurement location LT-2 was on a bluff overlooking the project site and adjacent to condominium units located at the northwest terminus of Seawitch Lane. The day-night average noise level calculated based on the measured data ranged from 49 to 56 dBA L_{dn} (excluding weather-affected data) with an average L_{dn} of 53 dBA. These data are summarized on Figures 10-17.

Long-term noise measurement site LT-3 was selected to represent the noise environment of residential land uses within the Harbor Park Apartments and along Winchester Street. The measurement site was located at the top of the hill east of the project site. The day-night average noise level calculated based on the measured data ranged from 50 to 54 dBA L_{dn} (excluding weather-affected data) with an average L_{dn} of 52 dBA. These data are summarized on Figures 18-25.

Site LT-4 was selected to represent the noise environment of noise-sensitive land uses along Lemon Street, west of Sonoma Boulevard. The measurement site was approximately 25 feet (8 meters) from the centers of Lemon Street and 3rd Street on the northwest corner of the intersection. The day-night average noise level calculated based on the measured data ranged from 56 to 59 dBA L_{dn} (excluding weather-affected data collected on Saturday, September 21, 2013) with an average L_{dn} of 57 dBA. These data are summarized on Figures 26-33.

Site LT-5 quantified ambient noise levels from vehicular traffic along Sonoma Boulevard. The measurement site was approximately 90 feet from the center of Sonoma Boulevard at the Norman C. King Community Center. The day-night average noise level calculated based on the measured data ranged from 62 to 65 dBA L_{dn} (excluding weather-affected data) with an average L_{dn} of 63 dBA. These data are summarized on Figures 34-41.

Short-term noise measurements were made at four additional locations to complete the ambient noise survey. The locations of the short-term noise measurements are shown on Figure 1a. Table 5, below, summarizes the noise level data collected at each of the sites.

Table 5: Summary of Short-Term Noise Measurement Data

Noise Measurement Location (Date)	Time Begin	L_{max}	$L_{(1)}$	$L_{(10)}$	$L_{(50)}$	$L_{(90)}$	10-min. L_{eq}
ST-1: Lake Dalwigk Park, 70 feet from the center of Lemon Street at Sheridan Street. (9/18/2013)	1450	73	71	62	52	47	59
	1500	69	66	61	53	76	57
ST-2: 75 feet from the center of Sonoma Boulevard south of Solano Avenue. (9/18/2013)	1520	74	72	66	59	53	62
	1530	72	70	67	61	53	63
ST-3: Center of Alden Park, Mare Island. (9/25/2013)	1100	71	65	56	44	41	53
	1110	63	60	50	43	39	48
ST-4: Easternmost terminus of York Street. (9/25/2013)	1140	61	61	55	48	46	51
	1150	57	54	51	49	47	49

Short-term noise measurement site ST-1 was approximately 70 feet from the center of Lemon Street in Lake Dalwigk Park. The measurement site represented the park and nearby residential land uses. The primary noise source affecting measured noise levels was vehicle traffic along Lemon Street. The ten-minute average noise level during the two measurements ranged from 57 to 59 dBA L_{eq} .

Noise measurement ST-2 was made at a distance of 75 feet from the centerline of Sonoma Boulevard south of Solano Avenue. This location was selected to quantify ambient traffic noise levels along Sonoma Boulevard. The ten-minute average noise level during the two measurements ranged from 62 to 63 dBA L_{eq} .

Short-term measurement sites ST-3 and ST-4 were selected to represent the noise environment at noise-sensitive receptors on Mare Island and along the railroad corridor that leads to and from the project site, respectively. Ambient noise levels at both short-term measurement sites were the result of local and distant vehicle traffic, with typical daytime noise levels ranging from 48 to 53 dBA L_{eq} .

Based on a review of the ambient long-term and short-term noise data, project-generated noise increases exceeding 5 dBA L_{dn} would be considered significant at Sandy Beach Road single-family residential land uses, multi-family residential units located along Seawitch Lane and within the Harbor Park Apartments, at single-family residences along Winchester Street, within Mare Island, or along the railroad corridor (receptors represented by LT-1, LT-2, LT-3, ST-3, or ST-4). Project-generated noise increases exceeding 3 dBA L_{dn} would be considered significant at noise-sensitive receptors represented by sites LT-4, LT-5, ST-1, or ST-2 (Lemon Street and Sonoma Boulevard).

Figure 1a Overview of Project Area Showing Noise Monitoring Locations

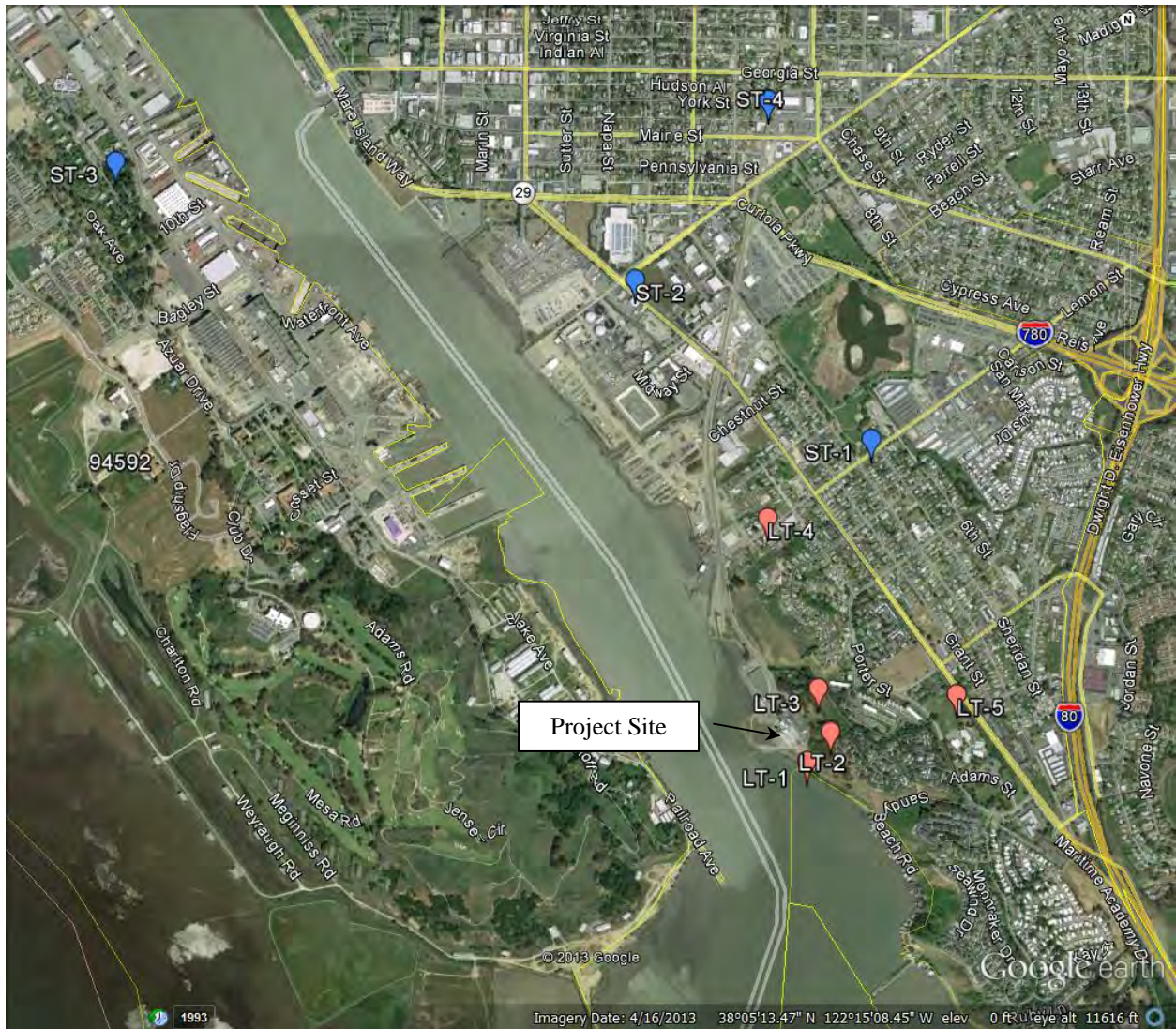

Figure 1b Project Vicinity Showing Long-Term Noise Monitoring Locations



**Noise Levels at Noise Measurement Site LT-1
Waterfront, 365 meters Northwest of Sandy Beach Road Residences
Wednesday, September 18, 2013**

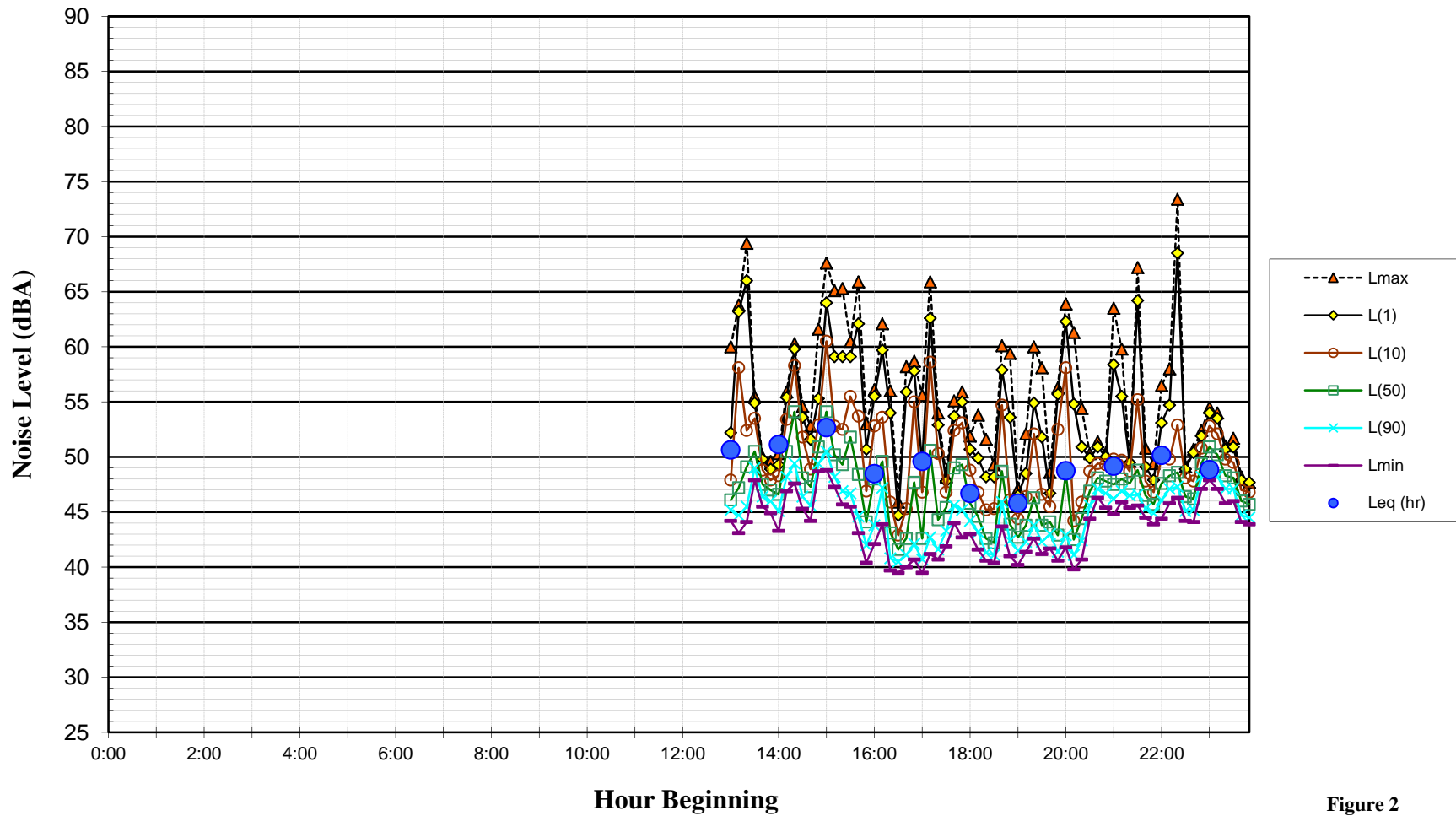

Figure 2

**Noise Levels at Noise Measurement Site LT-1
Waterfront, 365 meters Northwest of Sandy Beach Road Residences
Thursday, September 19, 2013**

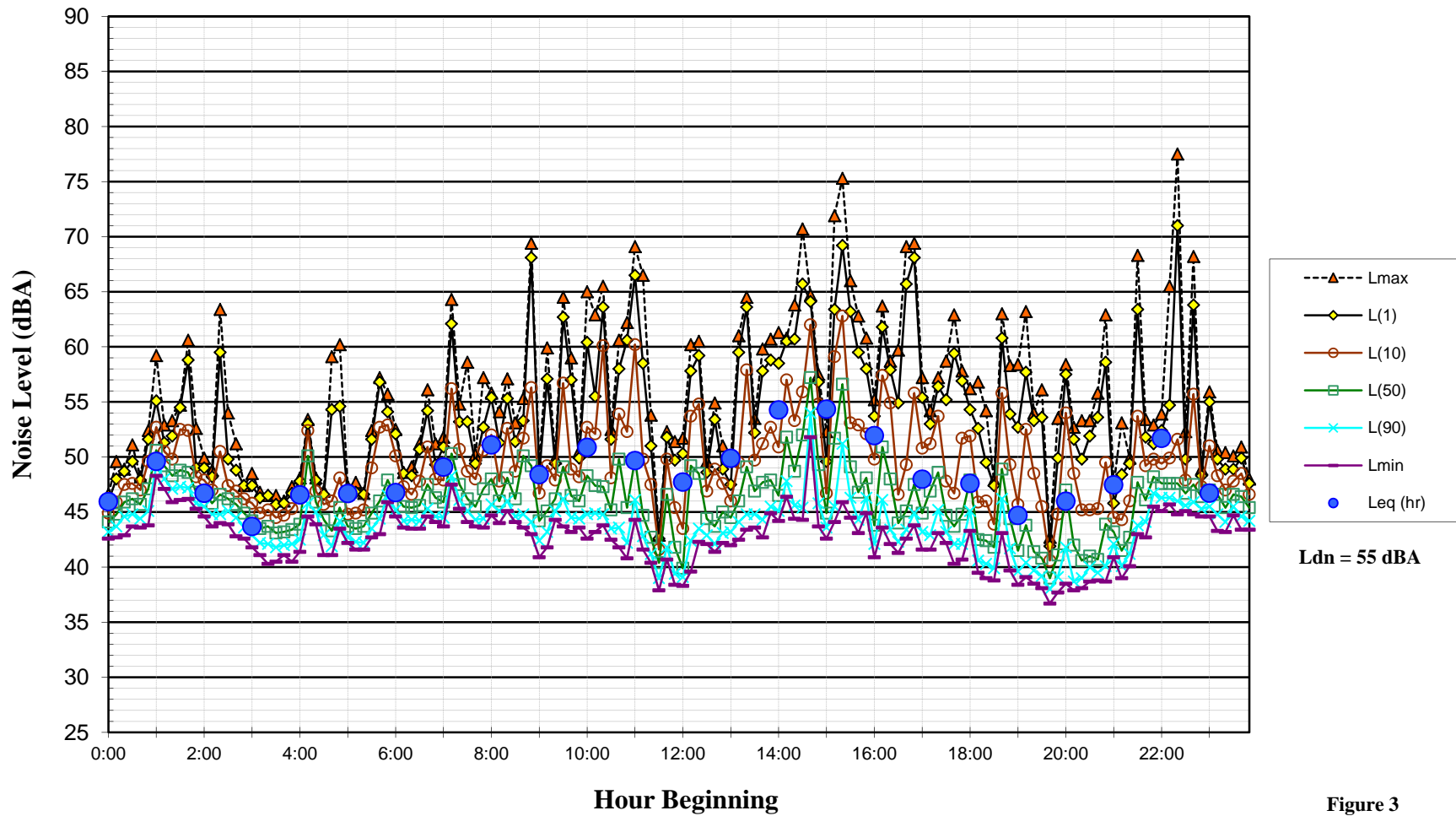

Figure 3

**Noise Levels at Noise Measurement Site LT-1
Waterfront, 365 meters Northwest of Sandy Beach Road Residences
Friday, September 20, 2013**

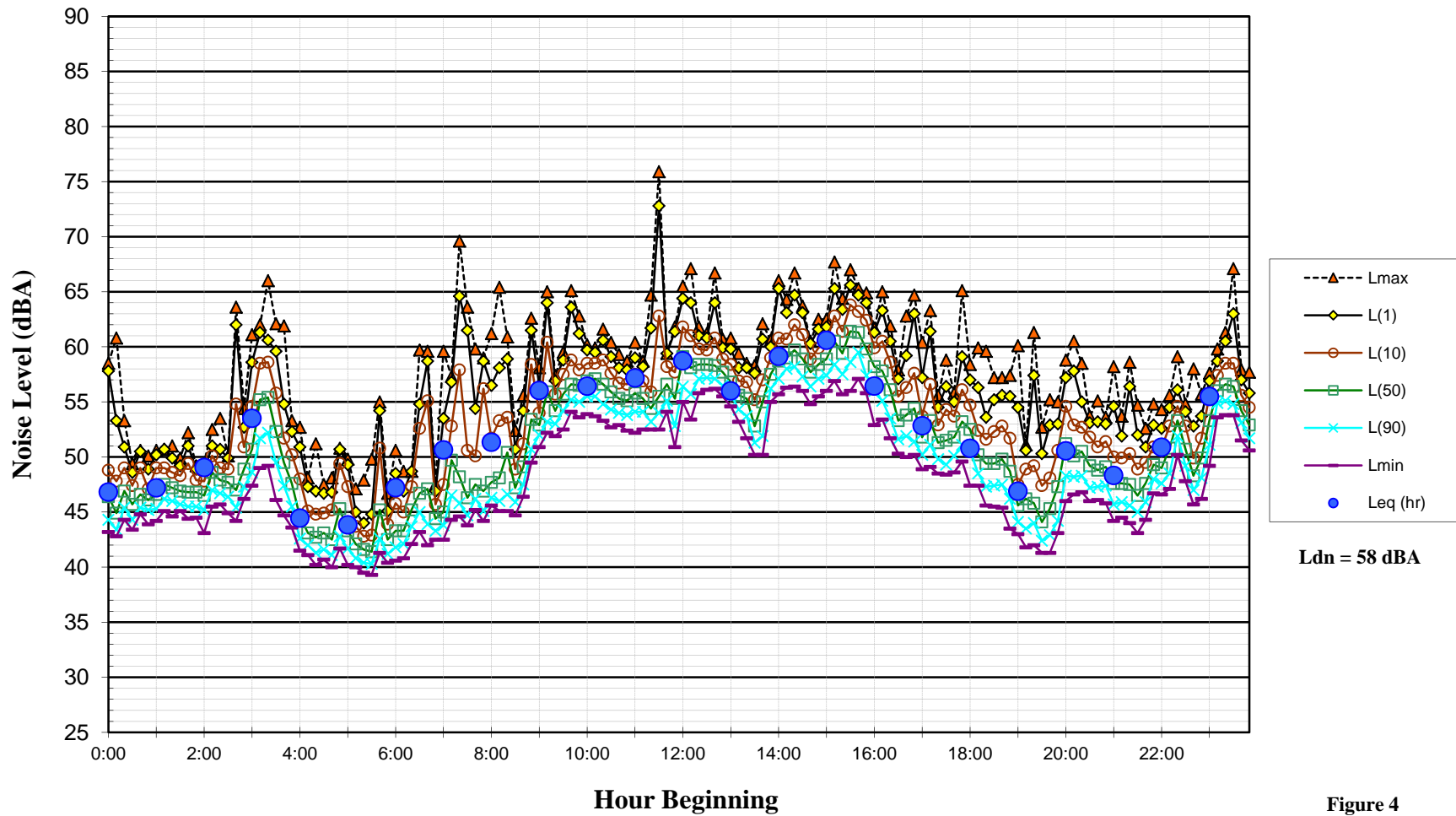
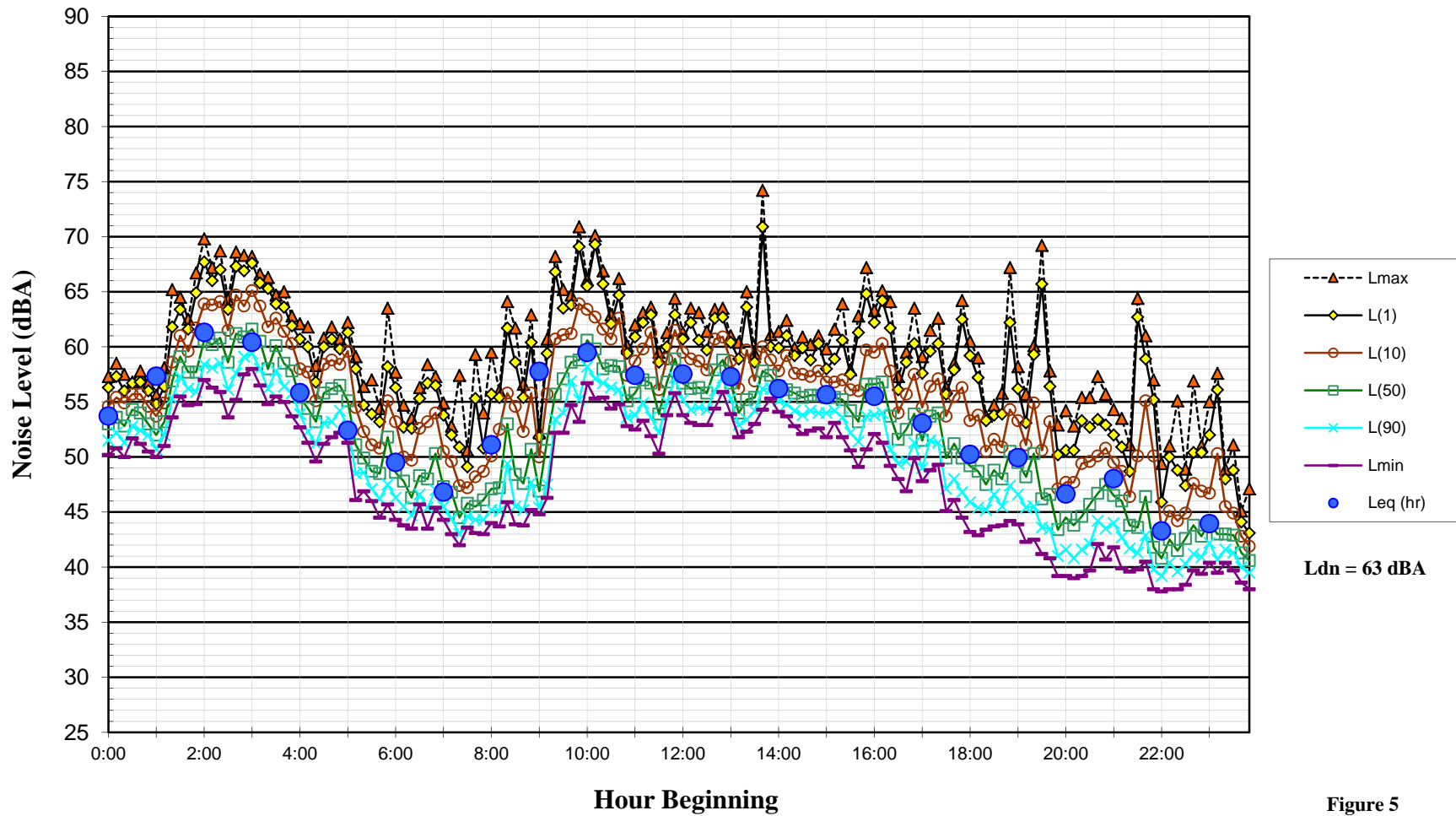

Figure 4

**Noise Levels at Noise Measurement Site LT-1
Waterfront, 365 meters Northwest of Sandy Beach Road Residences
Saturday, September 21, 2013**



Ldn = 63 dBA

Figure 5

**Noise Levels at Noise Measurement Site LT-1
Waterfront, 365 meters Northwest of Sandy Beach Road Residences
Sunday, September 22, 2013**

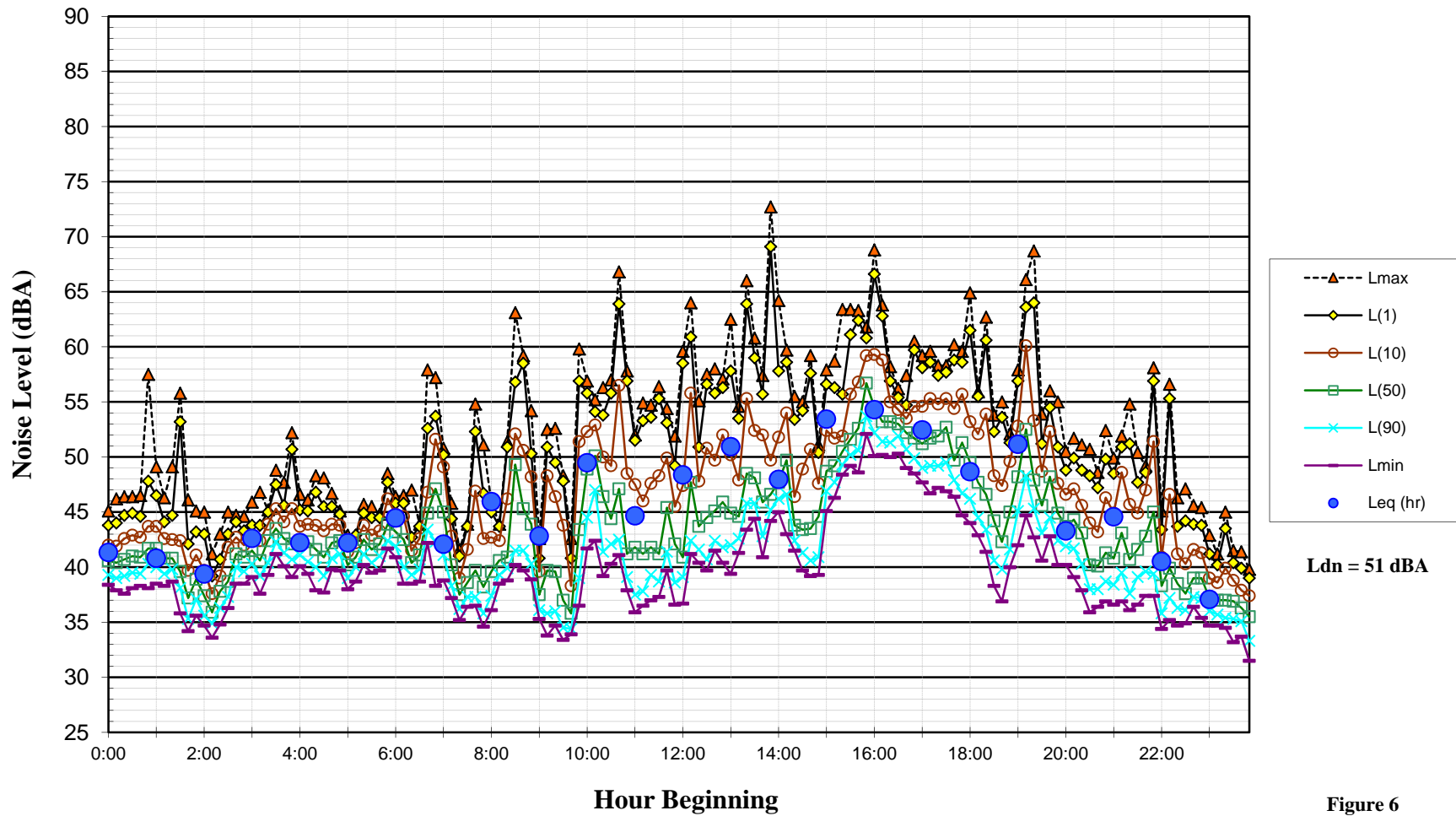

Figure 6

**Noise Levels at Noise Measurement Site LT-1
Waterfront, 365 meters Northwest of Sandy Beach Road Residences
Monday, September 23, 2013**

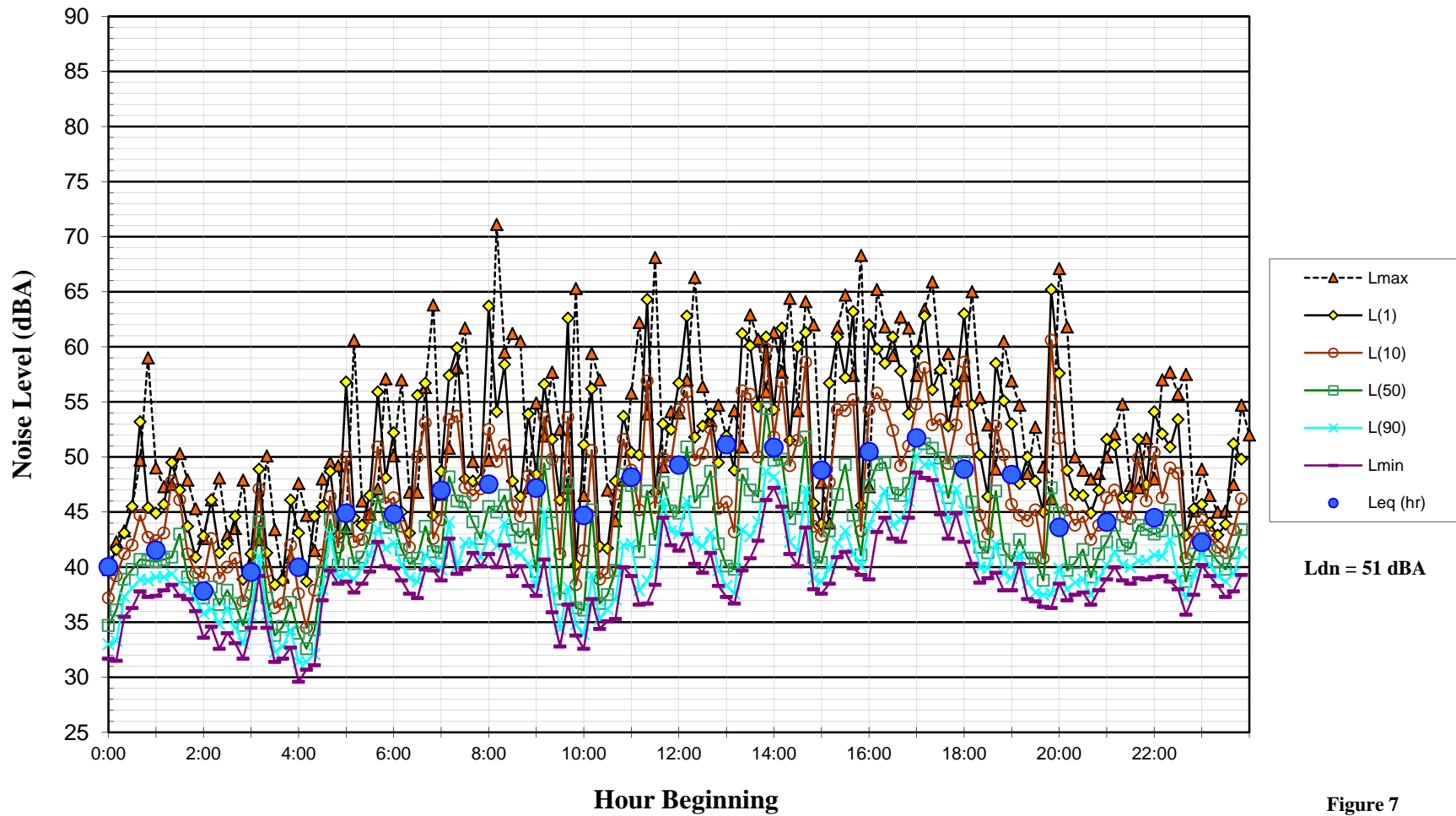

Figure 7

**Noise Levels at Noise Measurement Site LT-1
Waterfront, 365 meters Northwest of Sandy Beach Road Residences
Tuesday, September 24, 2013**

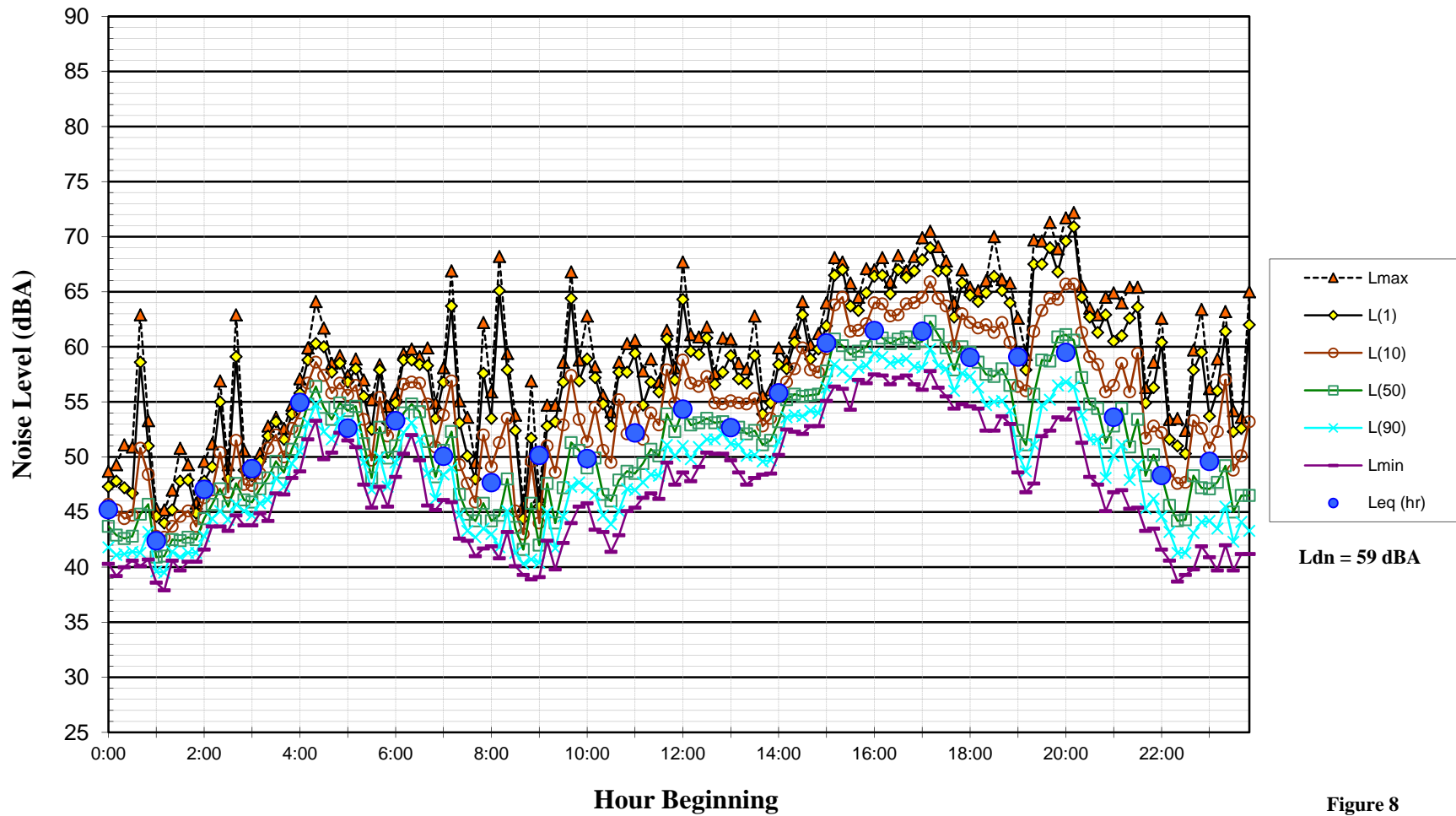

Figure 8

**Noise Levels at Noise Measurement Site LT-1
Waterfront, 365 meters Northwest of Sandy Beach Road Residences
Wednesday, September 25, 2013**

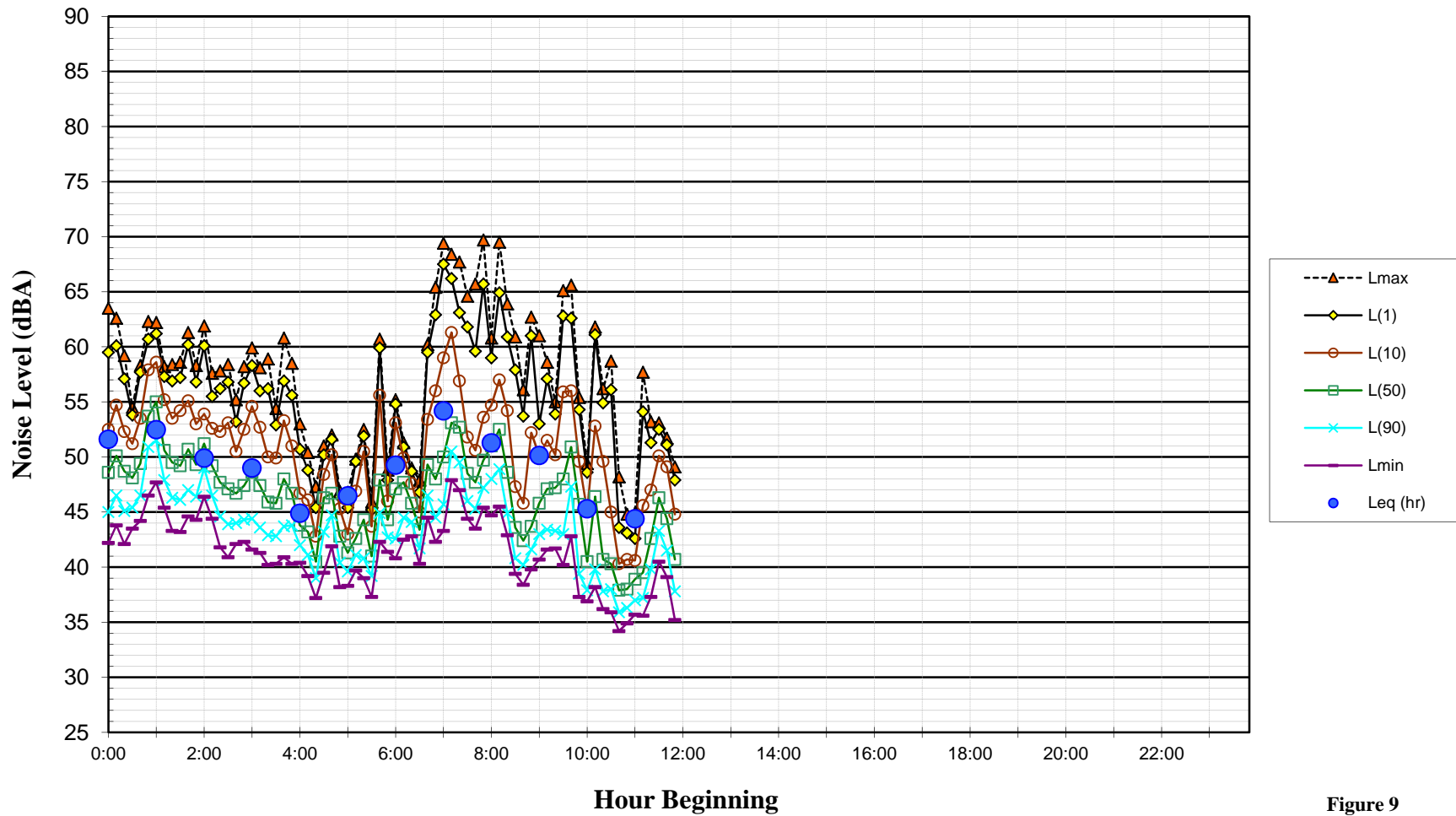

Figure 9

**Noise Levels at Noise Measurement Site LT-2
Adjacent to Seawitch Drive Condominiums Southeast of Site
Wednesday, September 18, 2013**

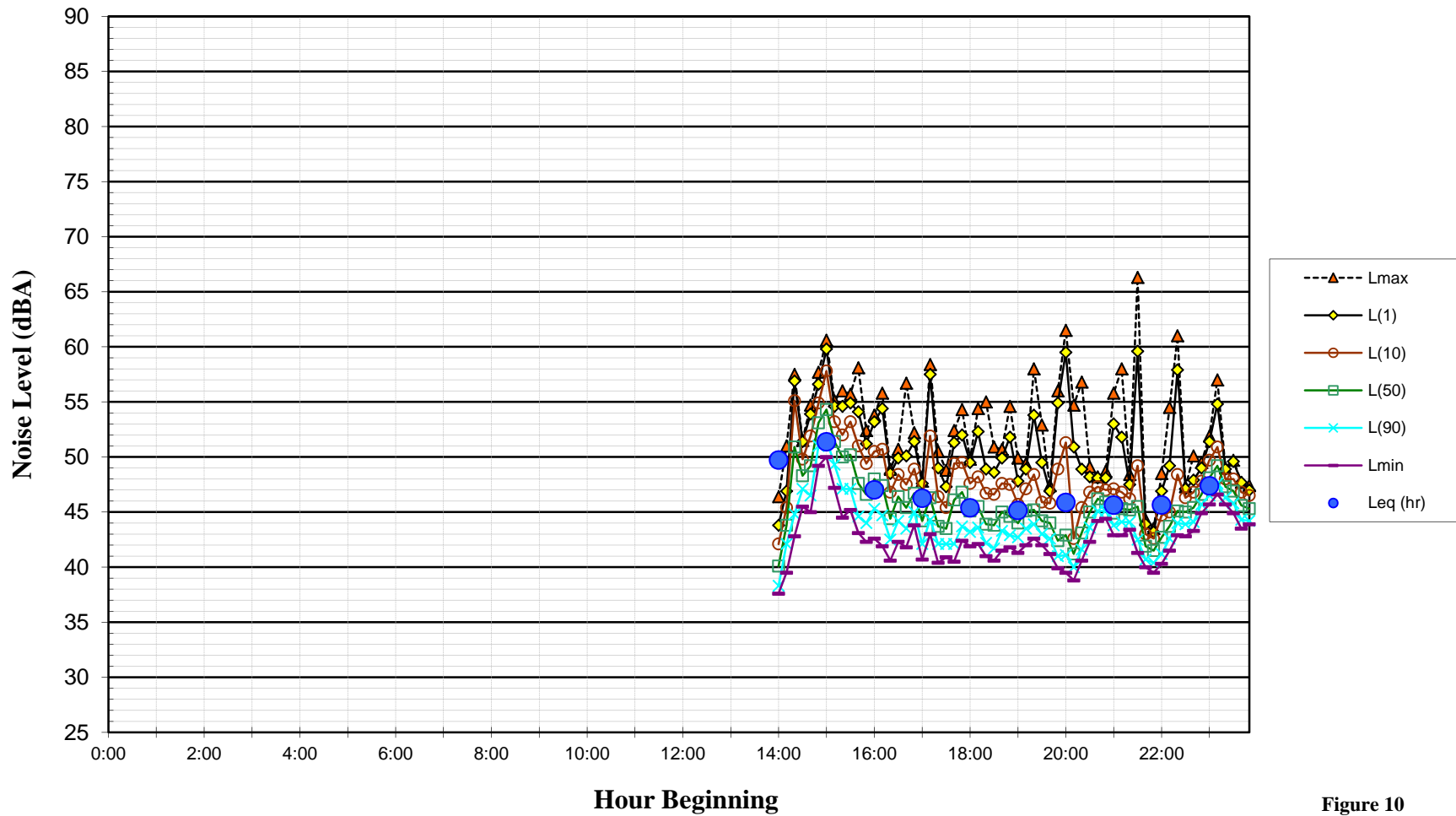
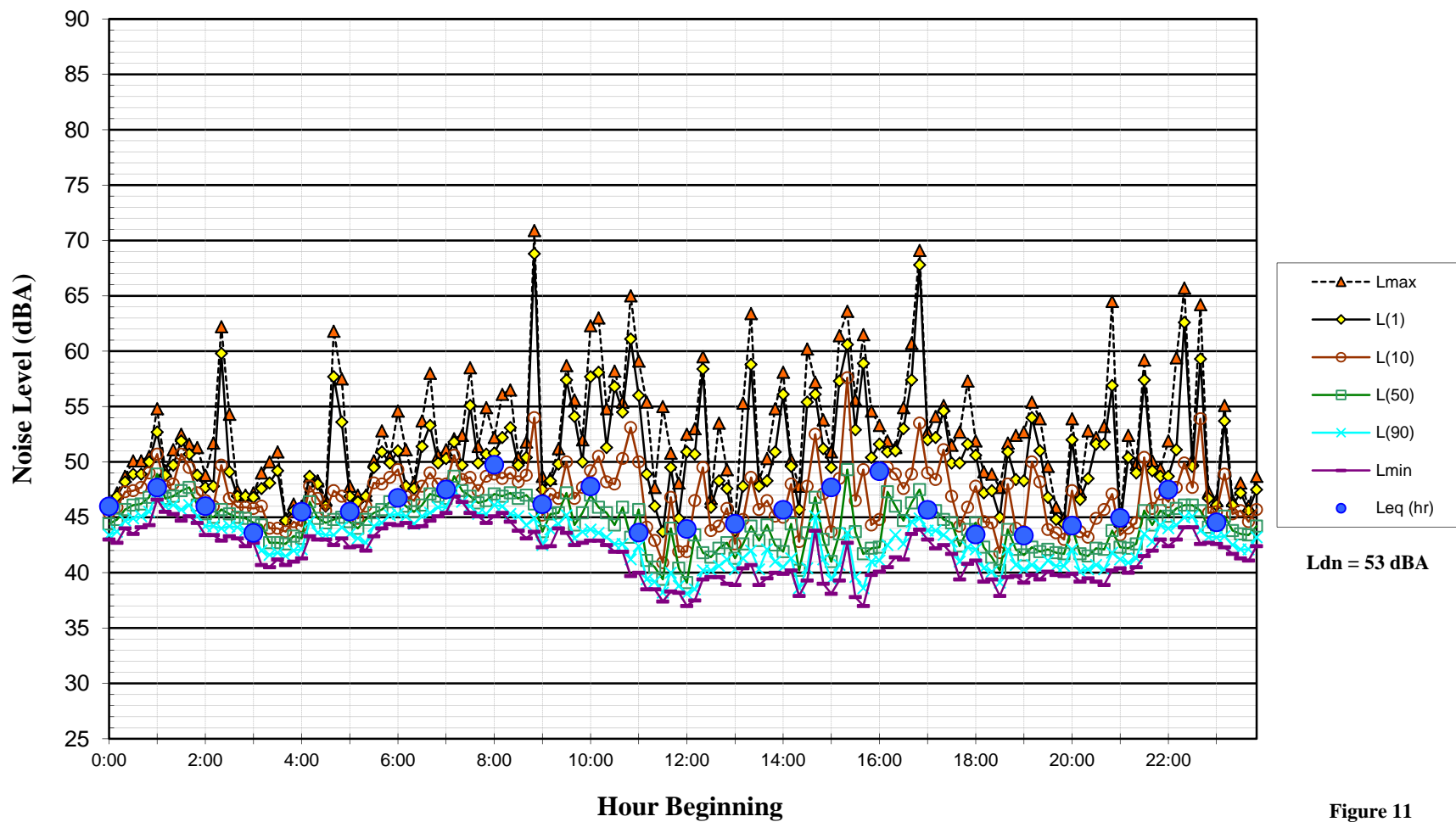

Figure 10

**Noise Levels at Noise Measurement Site LT-2
Adjacent to Seawitch Drive Condominiums Southeast of Site
Thursday, September 19, 2013**



Ldn = 53 dBA

Figure 11

**Noise Levels at Noise Measurement Site LT-2
Adjacent to Seawitch Drive Condominiums Southeast of Site
Friday, September 20, 2013**

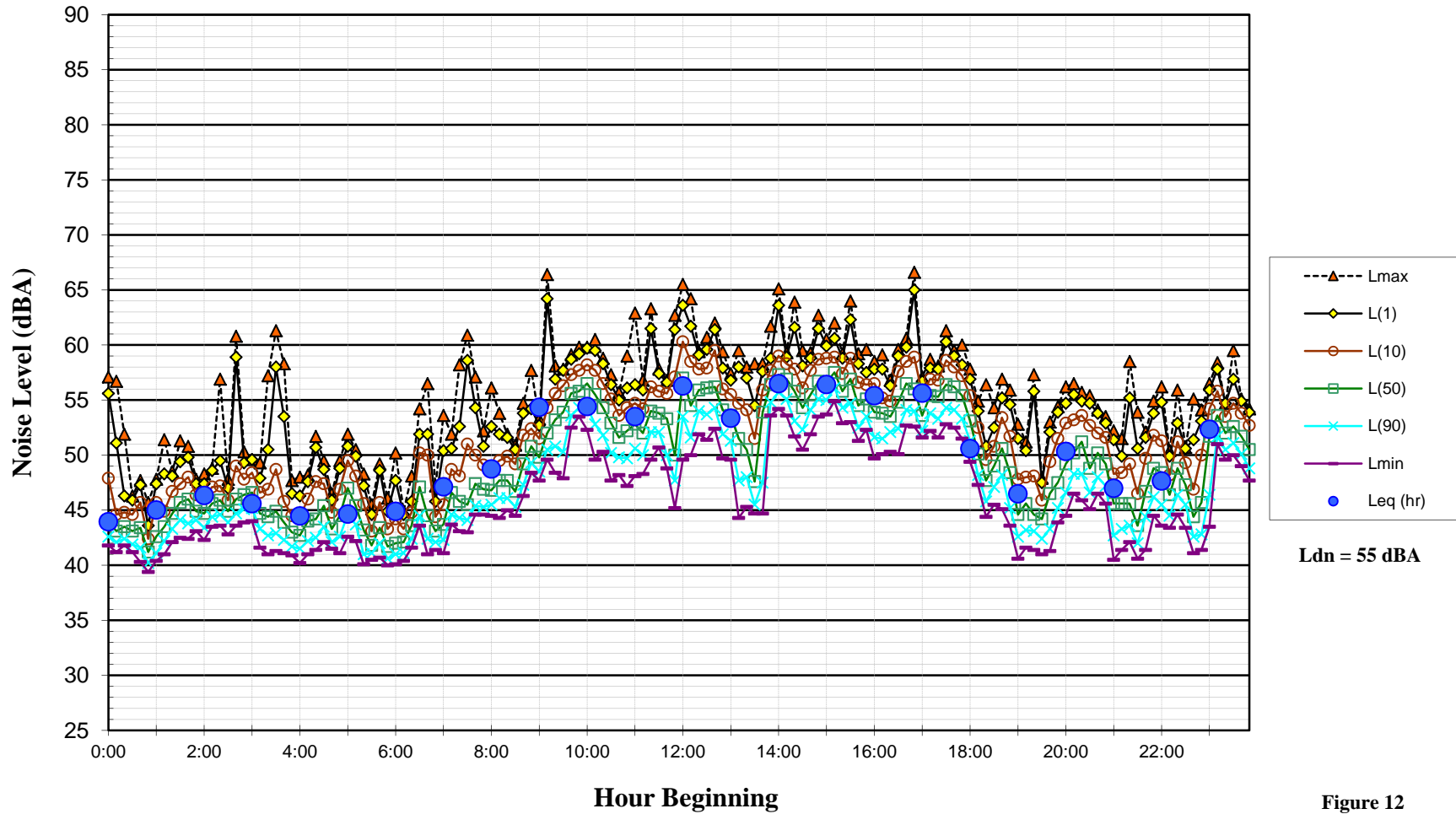

Figure 12

**Noise Levels at Noise Measurement Site LT-2
Adjacent to Seawitch Drive Condominiums Southeast of Site
Saturday, September 21, 2013**

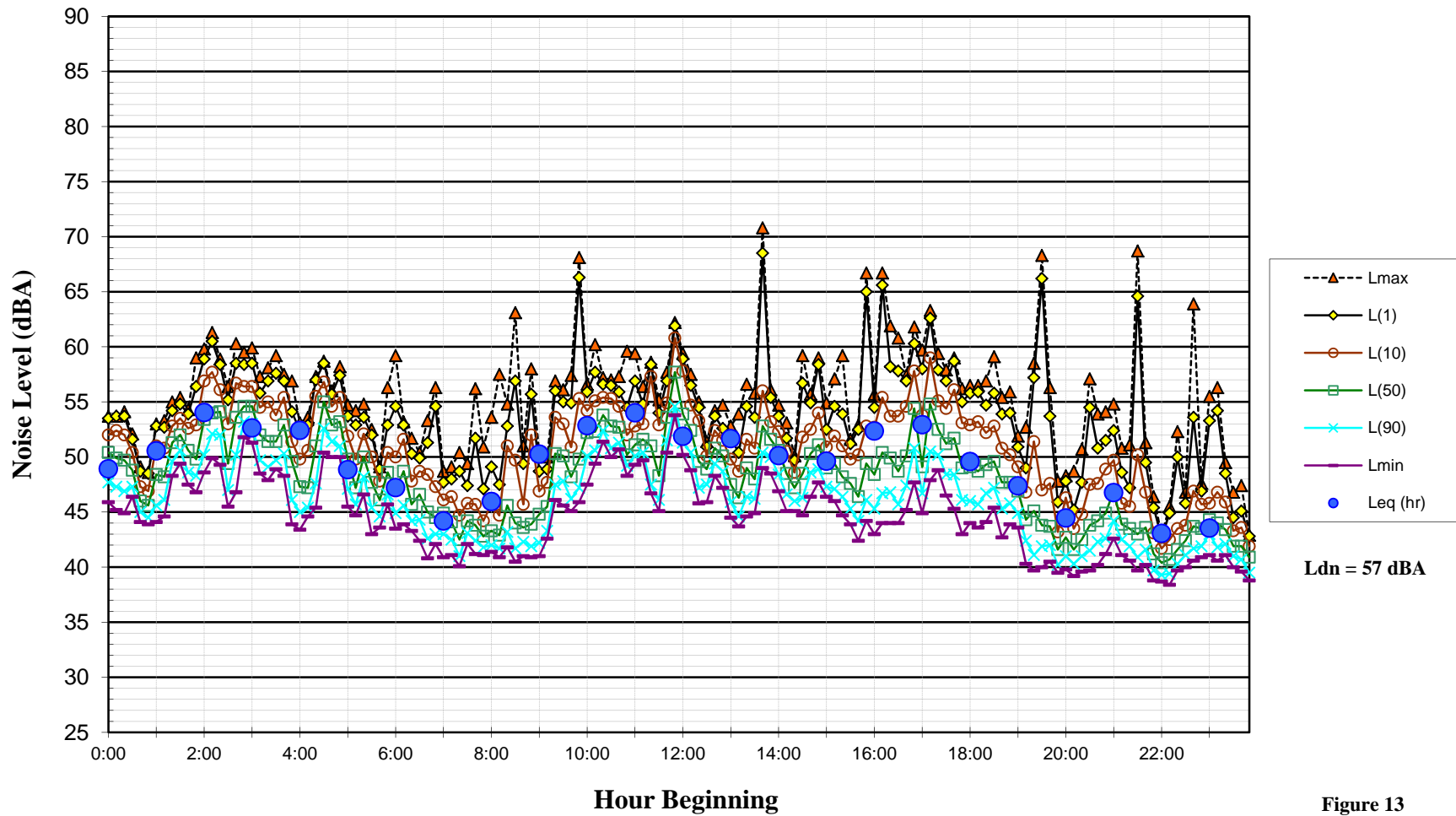

Figure 13

**Noise Levels at Noise Measurement Site LT-2
Adjacent to Seawitch Drive Condominiums Southeast of Site
Sunday, September 22, 2013**

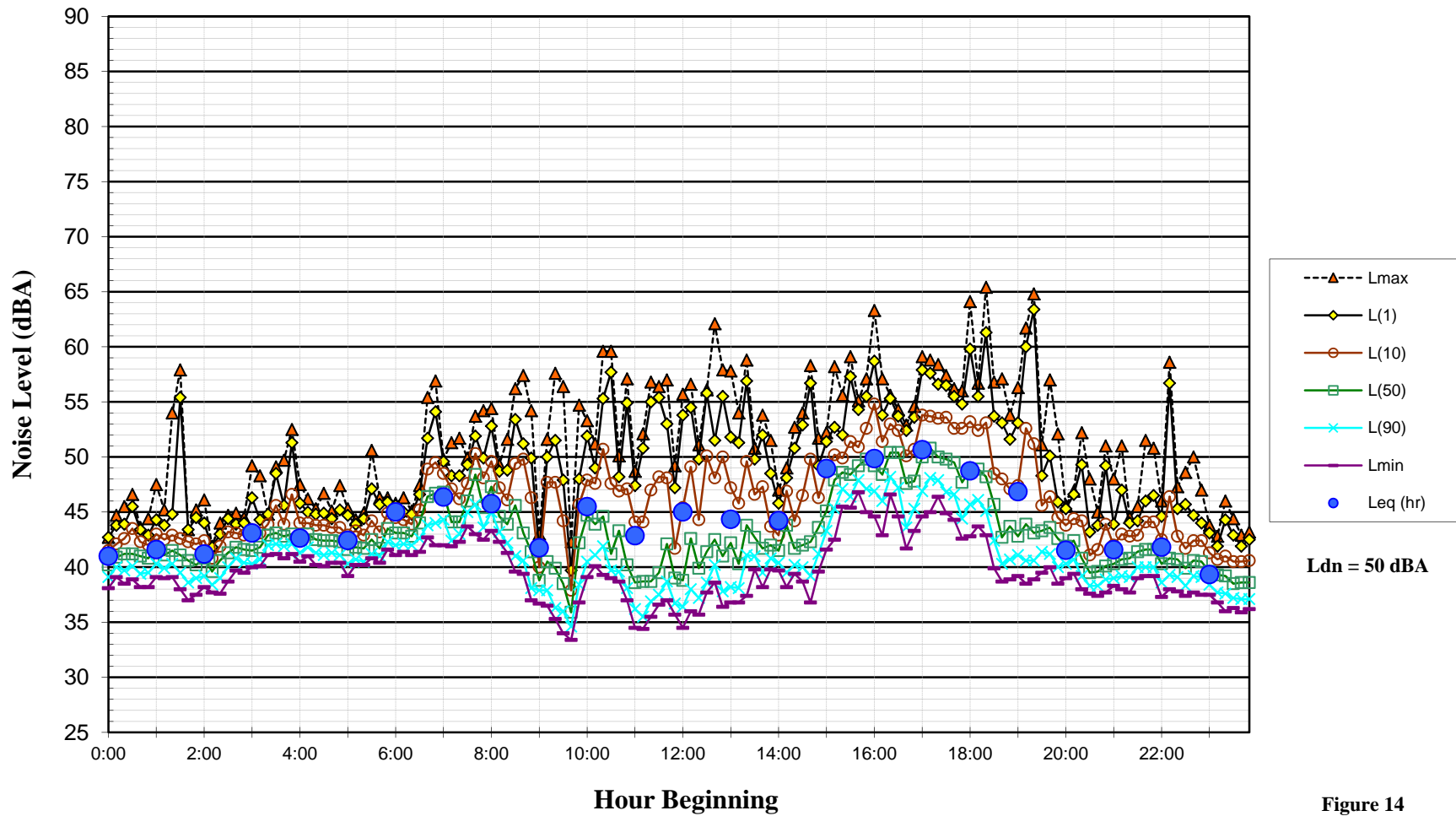

Figure 14

**Noise Levels at Noise Measurement Site LT-2
Adjacent to Seawitch Drive Condominiums Southeast of Site
Monday, September 23, 2013**

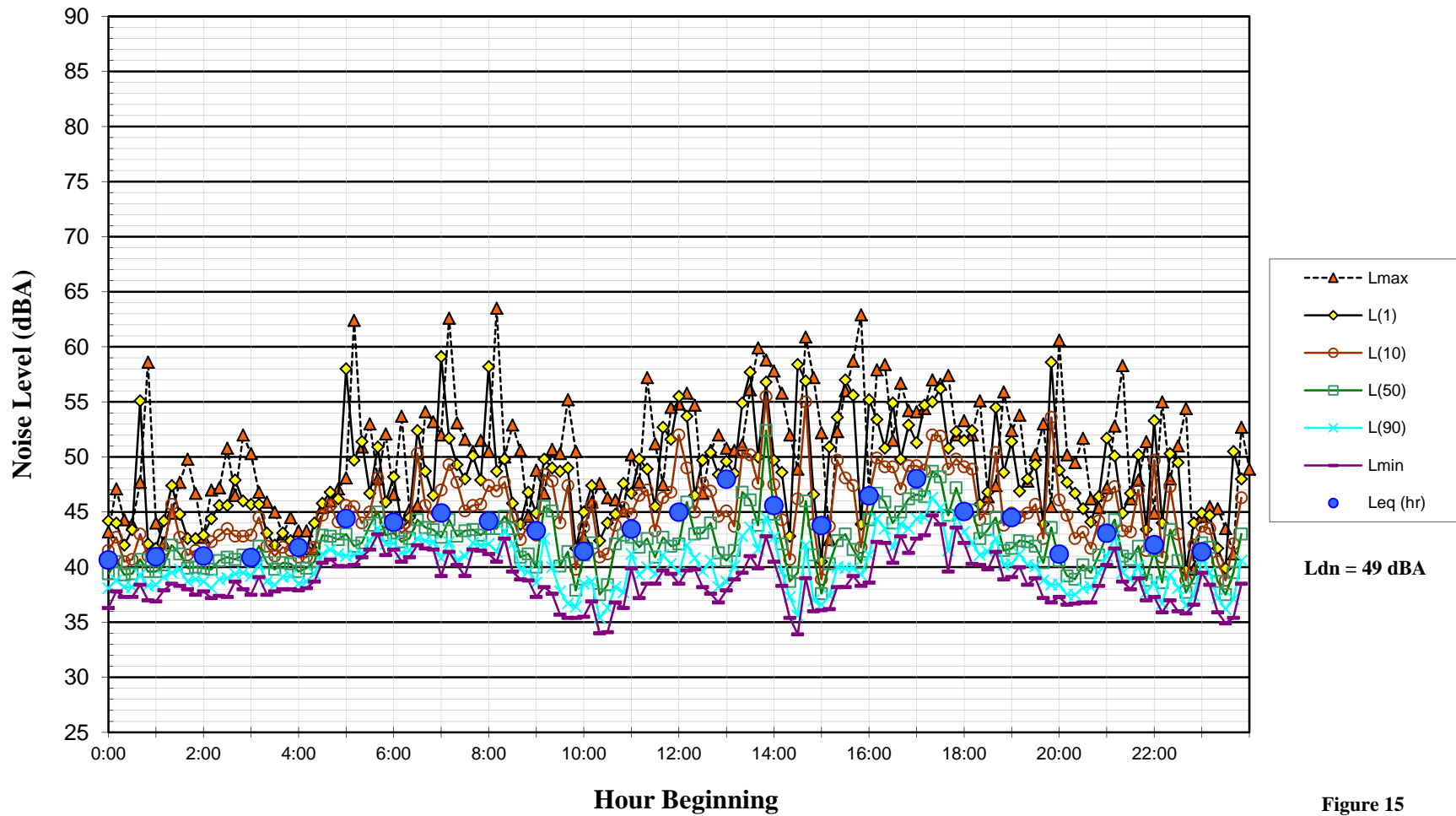
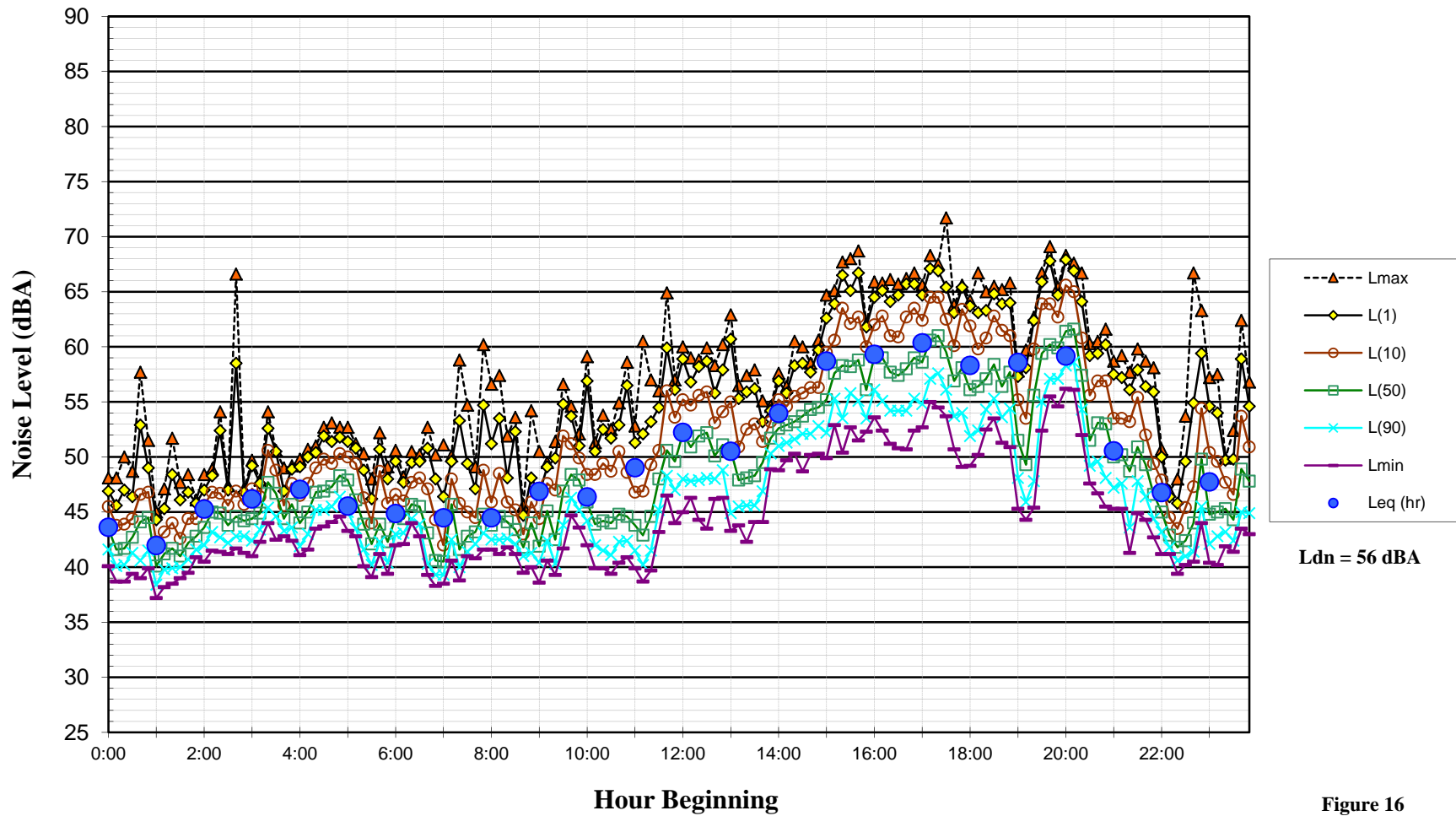

Figure 15

**Noise Levels at Noise Measurement Site LT-2
Adjacent to Seawitch Drive Condominiums Southeast of Site
Tuesday, September 24, 2013**



Ldn = 56 dBA

Figure 16

**Noise Levels at Noise Measurement Site LT-2
Adjacent to Seawitch Drive Condominiums Southeast of Site
Wednesday, September 25, 2013**

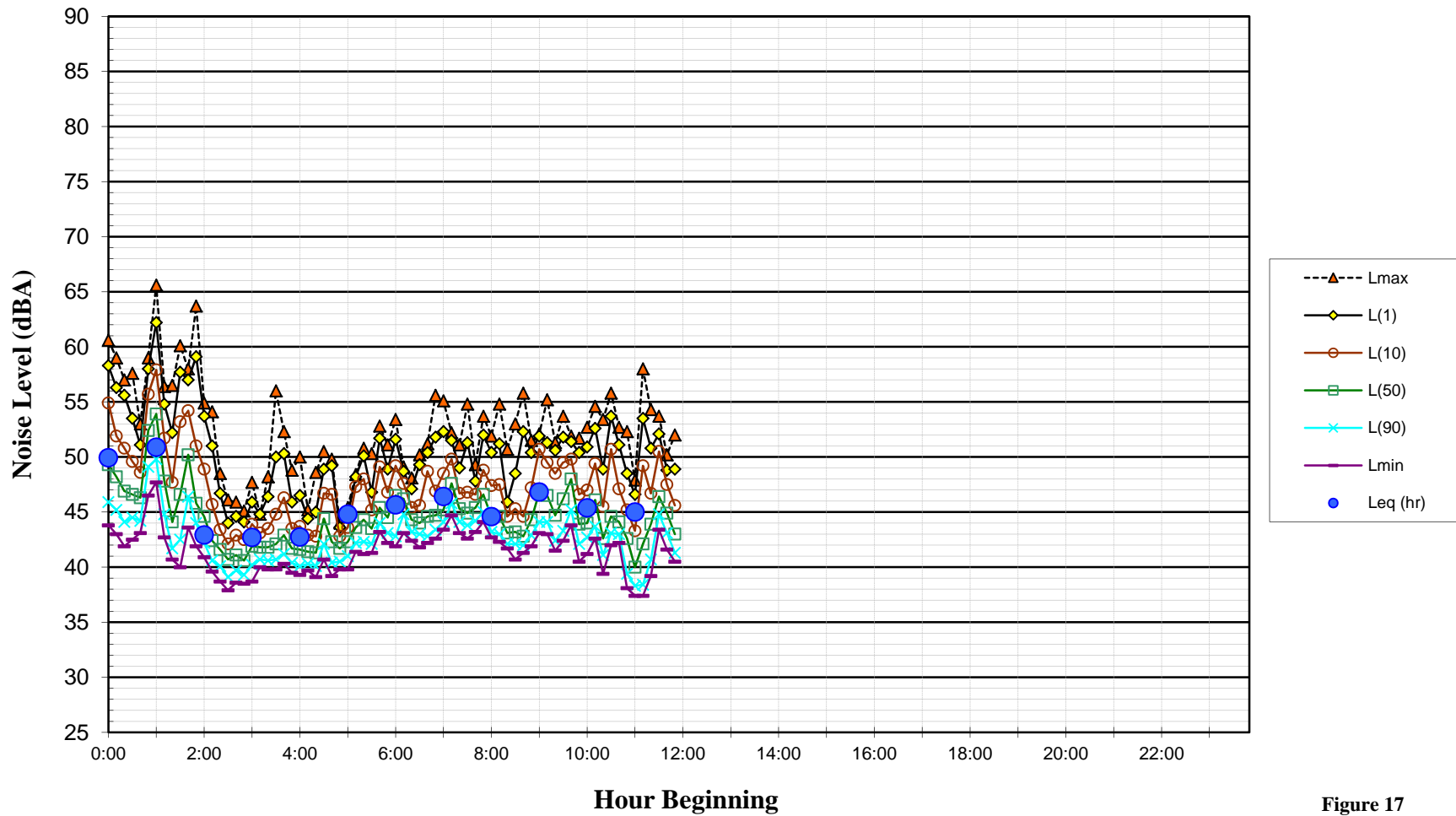

Figure 17

**Noise Levels at Noise Measurement Site LT-3
Top of Hill Overlooking Site Adjacent to Harbor Park Apartments
Wednesday, September 18, 2013**

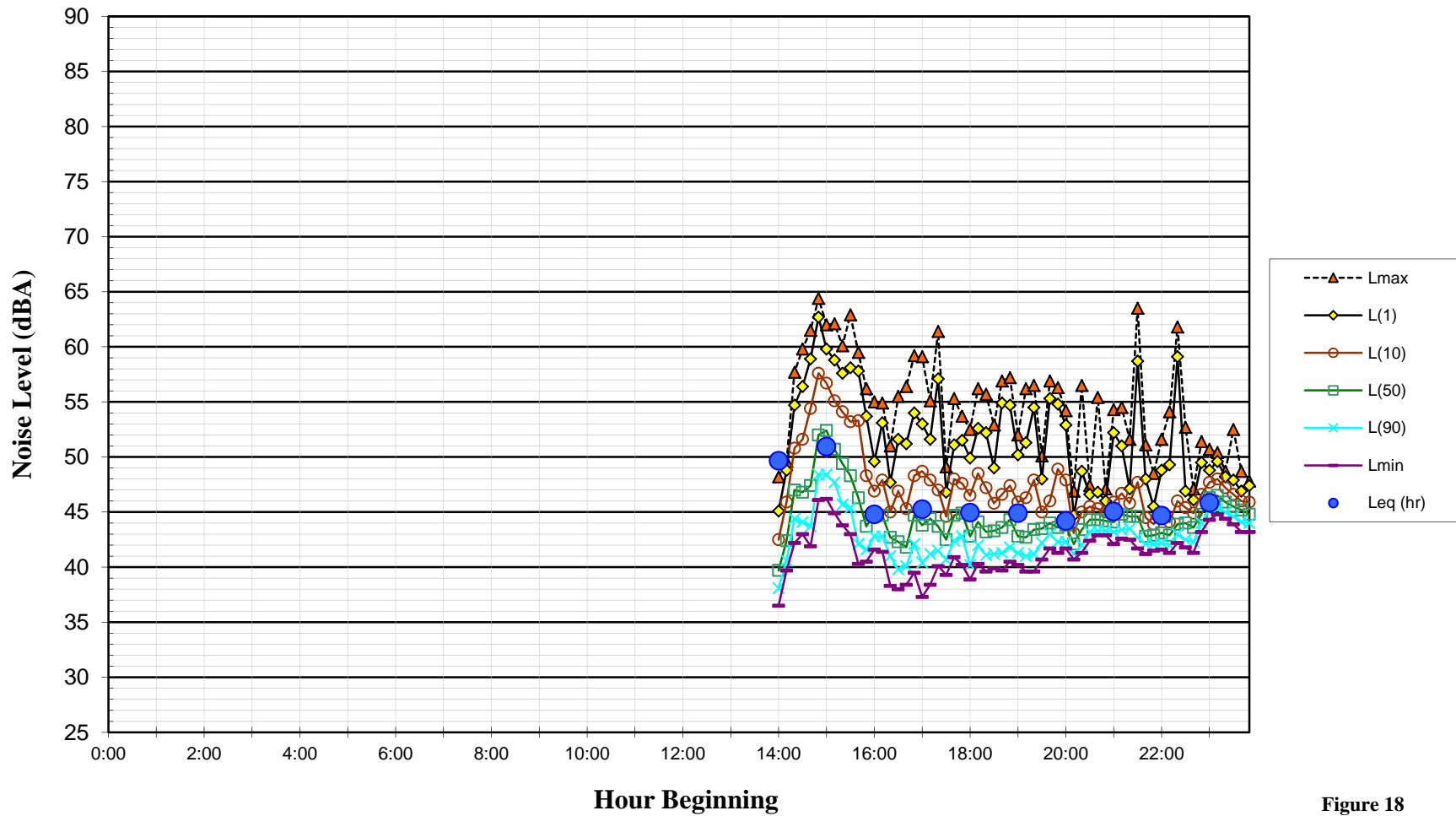

Figure 18

**Noise Levels at Noise Measurement Site LT-3
Top of Hill Overlooking Site Adjacent to Harbor Park Apartments
Thursday, September 19, 2013**

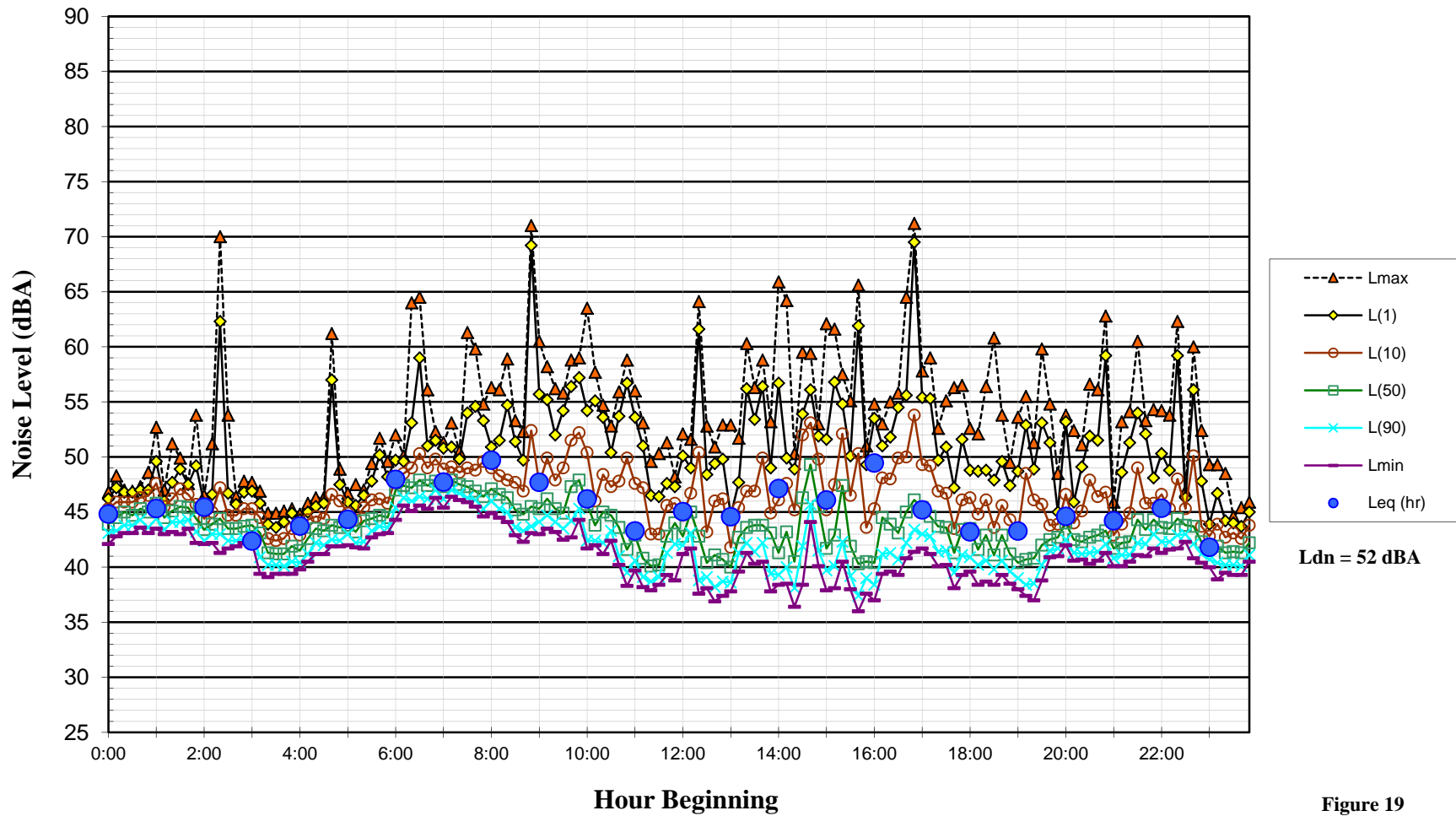

Figure 19

**Noise Levels at Noise Measurement Site LT-3
Top of Hill Overlooking Site Adjacent to Harbor Park Apartments
Friday, September 20, 2013**

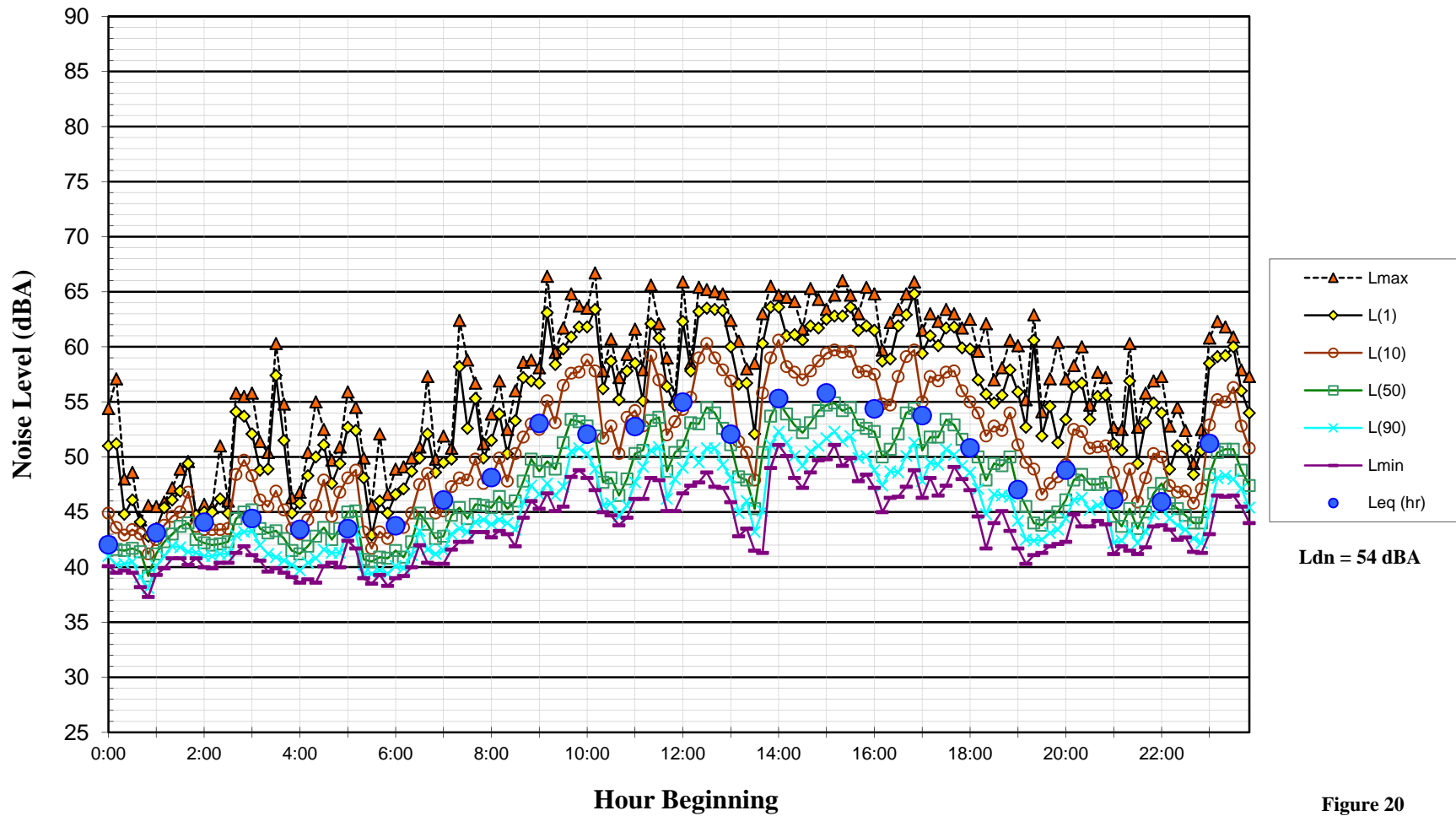

Figure 20

**Noise Levels at Noise Measurement Site LT-3
Top of Hill Overlooking Site Adjacent to Harbor Park Apartments
Saturday, September 21, 2013**

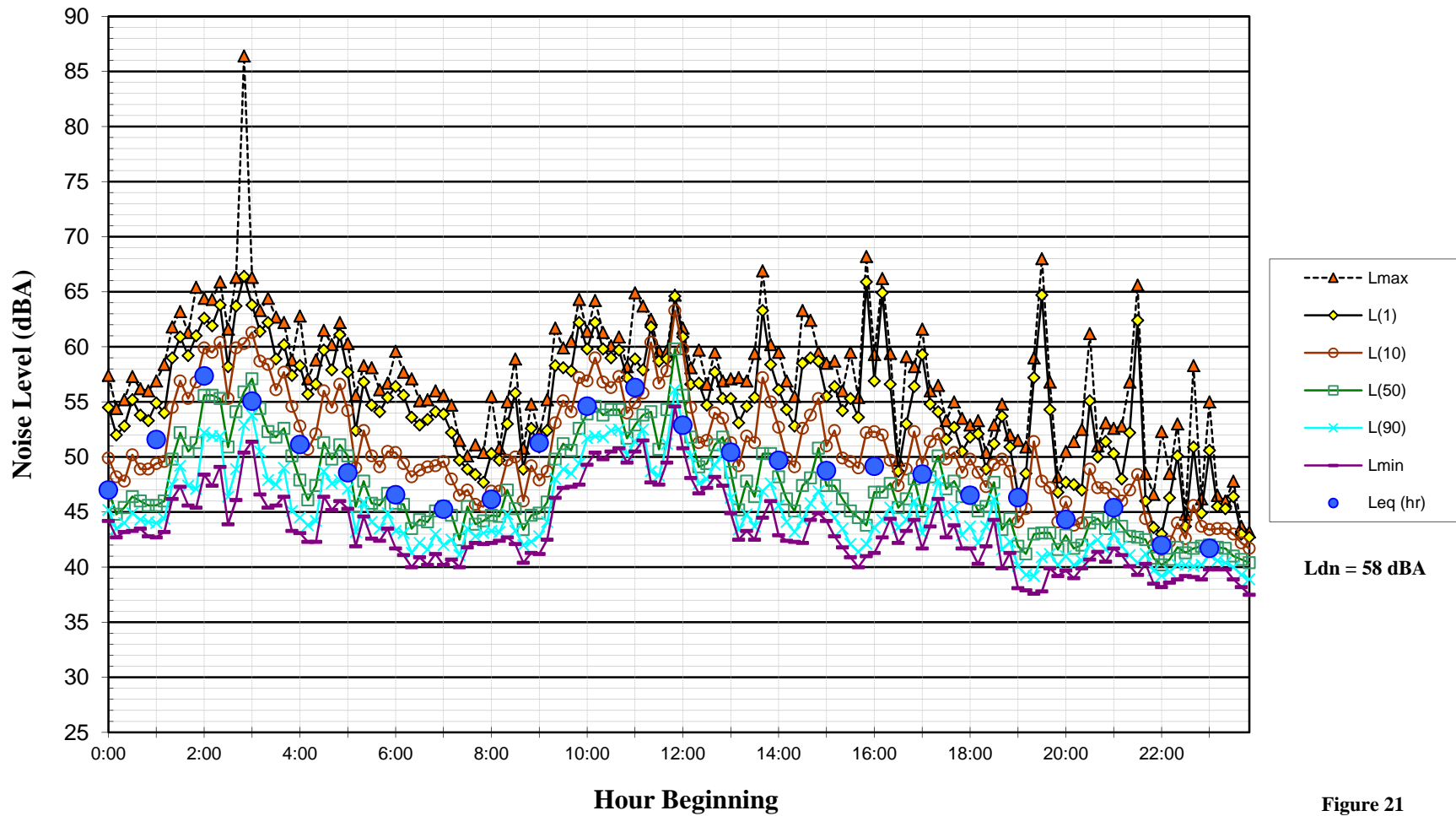
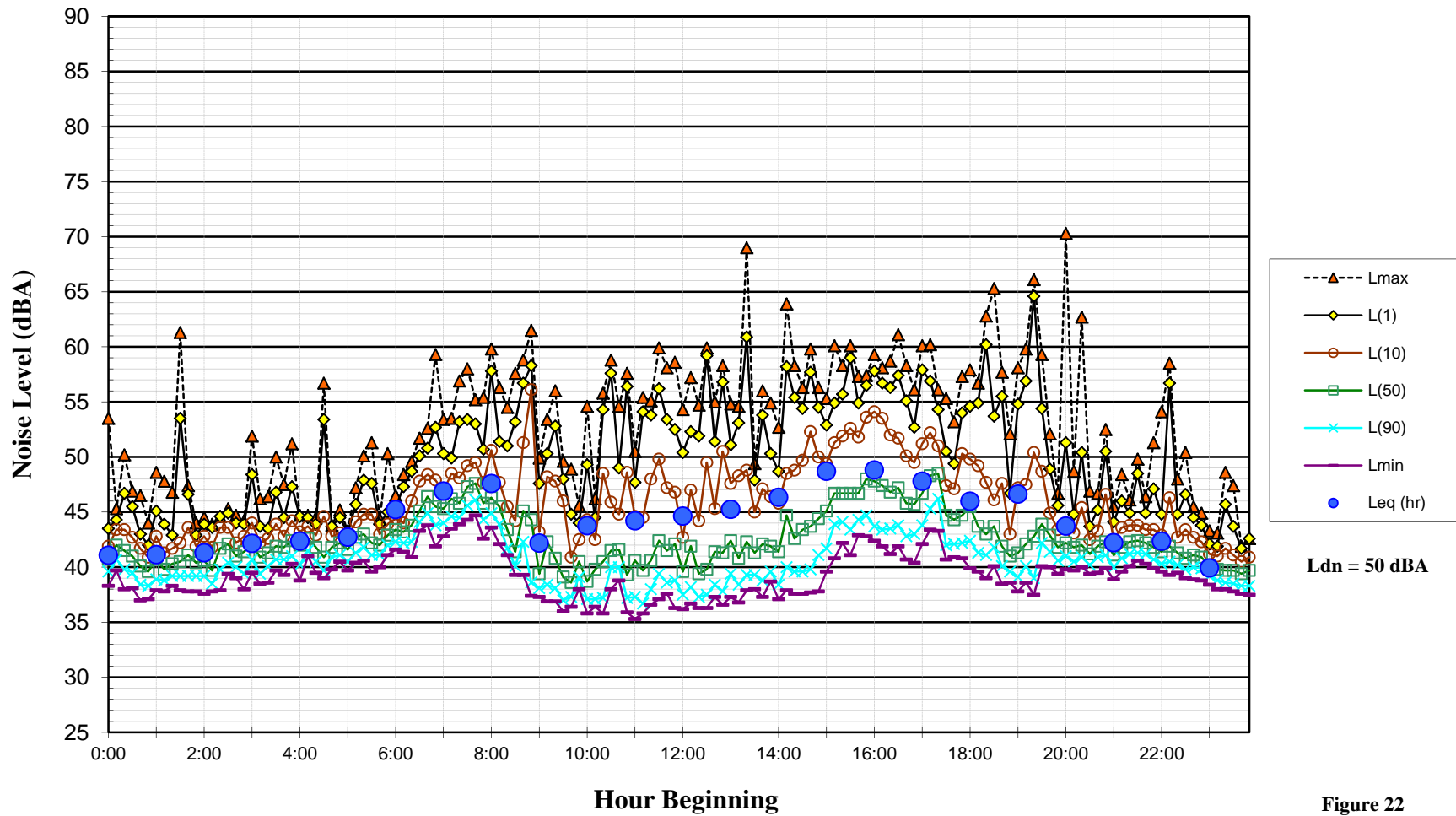

Figure 21

**Noise Levels at Noise Measurement Site LT-3
Top of Hill Overlooking Site Adjacent to Harbor Park Apartments
Sunday, September 22, 2013**



Ldn = 50 dBA

Figure 22

**Noise Levels at Noise Measurement Site LT-3
Top of Hill Overlooking Site Adjacent to Harbor Park Apartments
Monday, September 23, 2013**

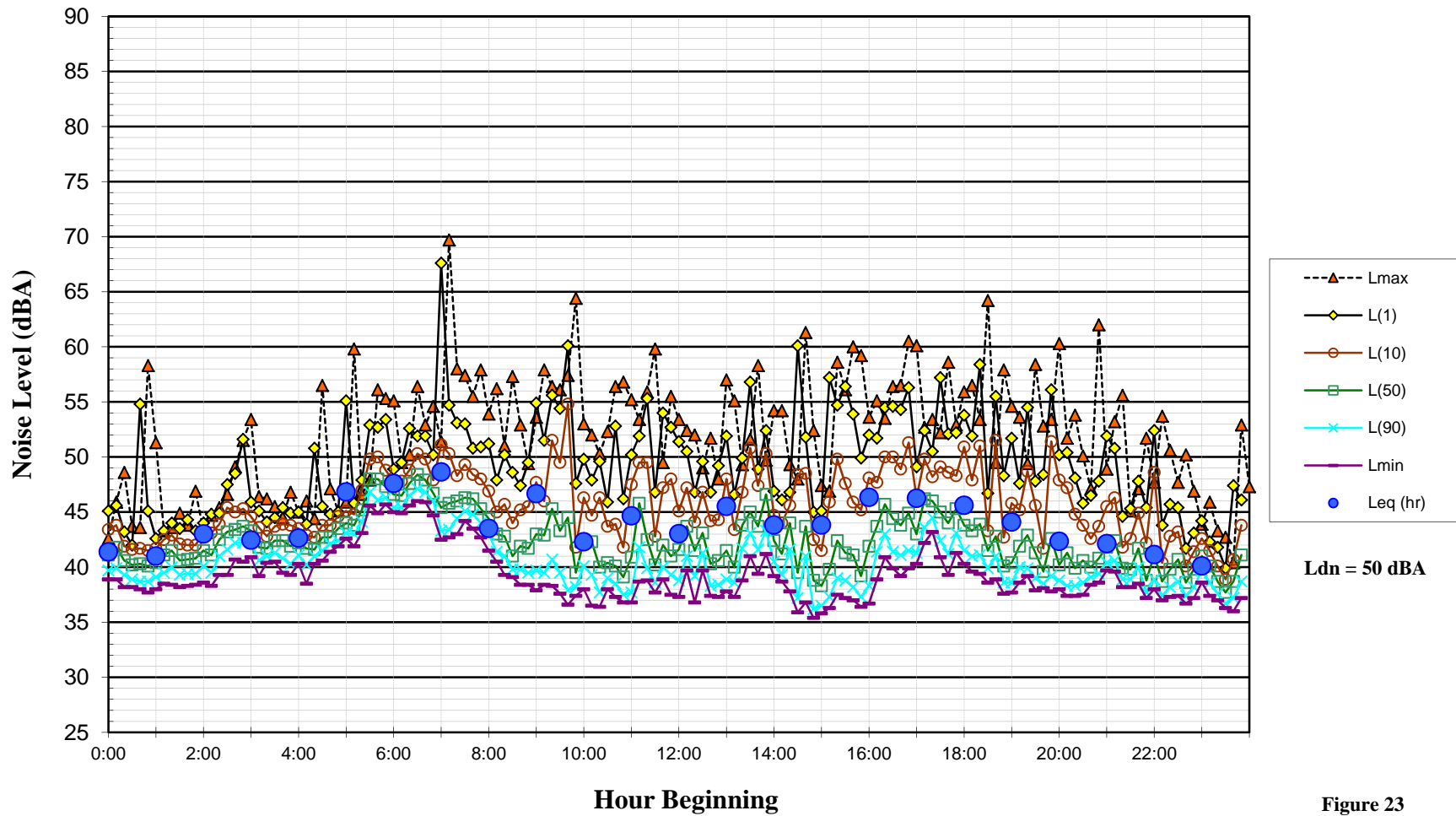

Figure 23

**Noise Levels at Noise Measurement Site LT-3
Top of Hill Overlooking Site Adjacent to Harbor Park Apartments
Tuesday, September 24, 2013**

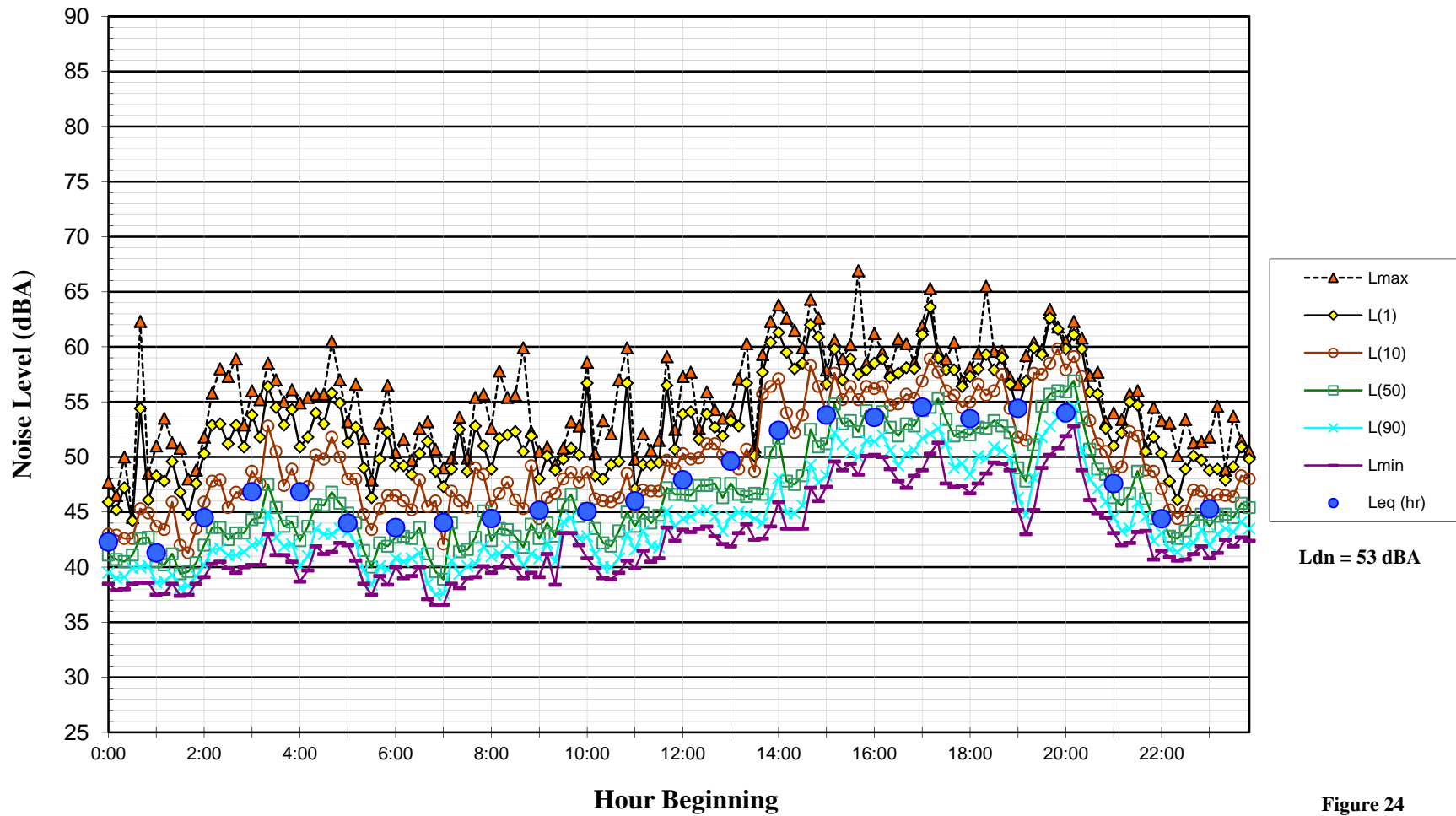

Figure 24

**Noise Levels at Noise Measurement Site LT-3
Top of Hill Overlooking Site Adjacent to Harbor Park Apartments
Wednesday, September 25, 2013**

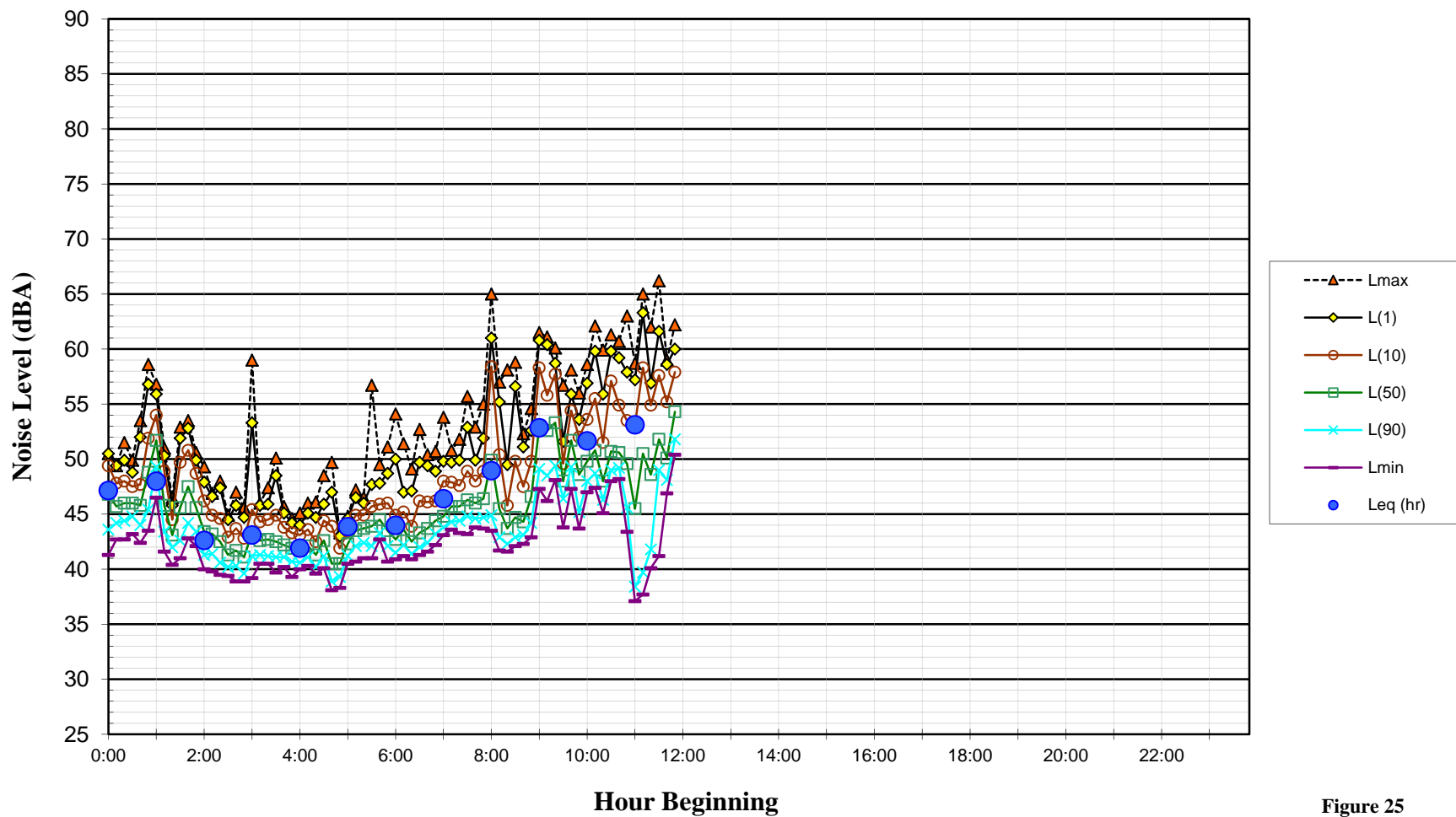

Figure 25

**Noise Levels at Noise Measurement Site LT-4
Northwest Corner of Lemon Street and 3rd Street
Wednesday, September 18, 2013**

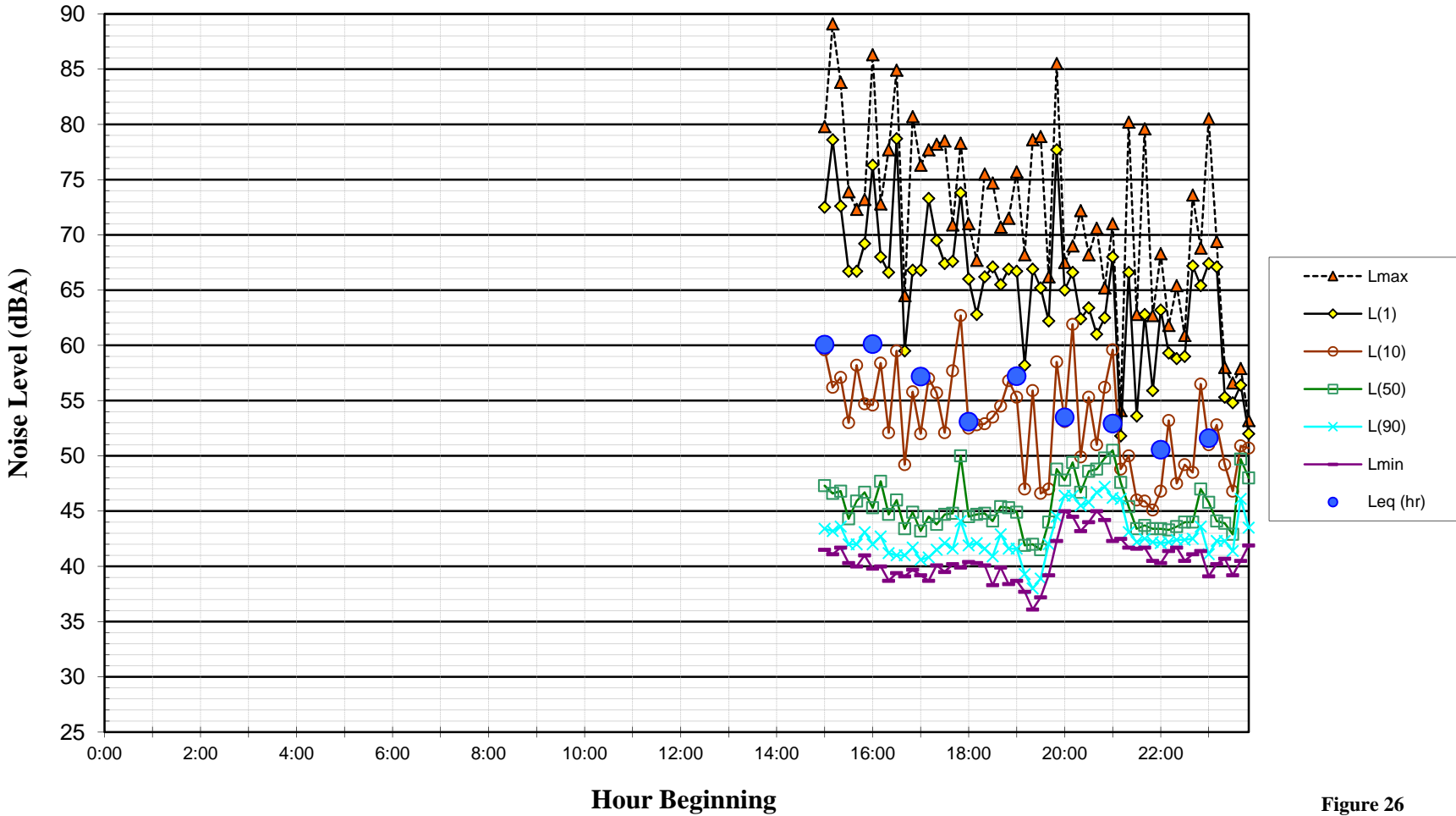
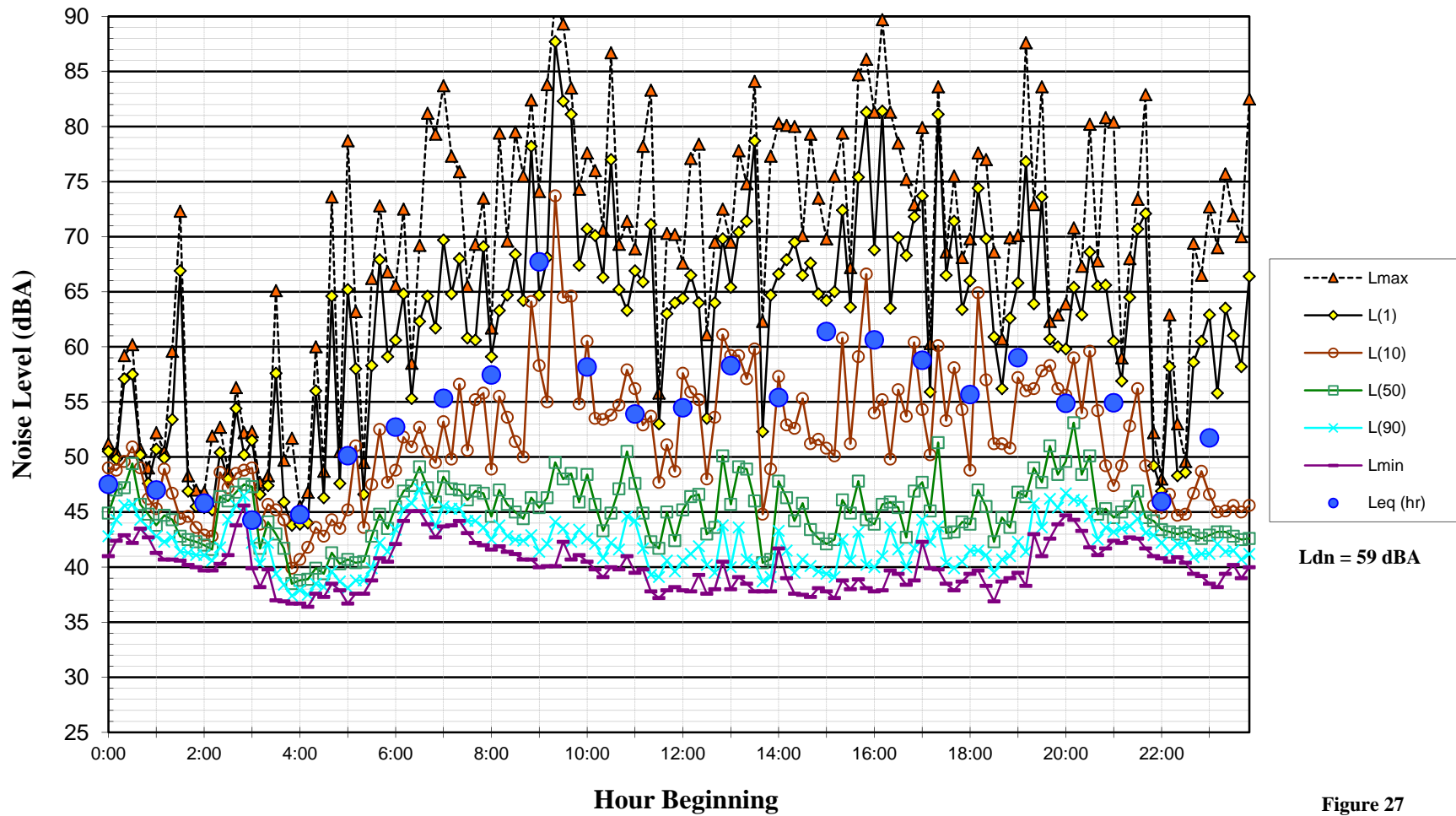

Figure 26

**Noise Levels at Noise Measurement Site LT-4
Northwest Corner of Lemon Street and 3rd Street
Thursday, September 19, 2013**



Ldn = 59 dBA

Figure 27

**Noise Levels at Noise Measurement Site LT-4
Northwest Corner of Lemon Street and 3rd Street
Friday, September 20, 2013**

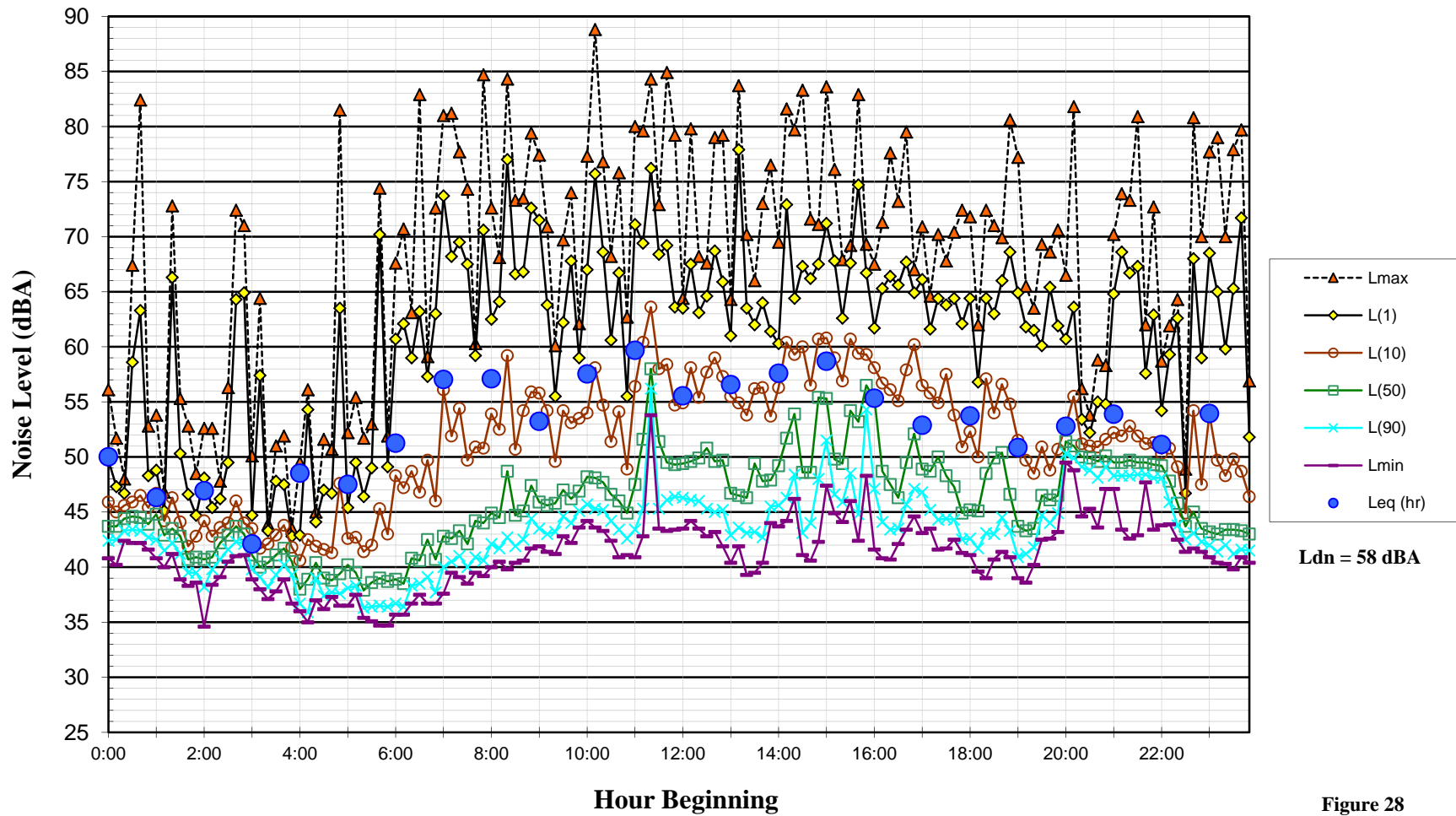

Figure 28

**Noise Levels at Noise Measurement Site LT-4
Northwest Corner of Lemon Street and 3rd Street
Saturday, September 21, 2013**

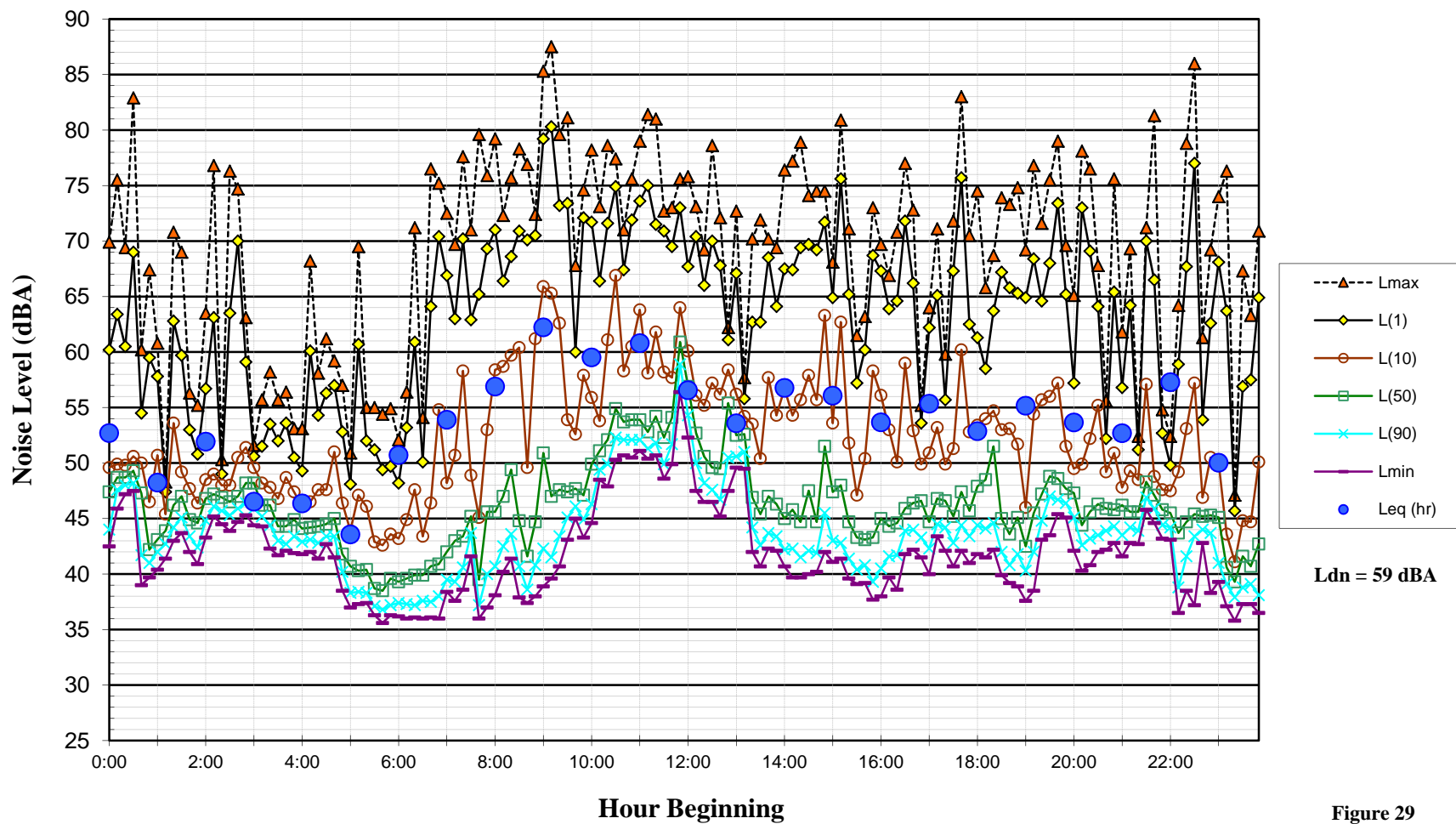

Figure 29

**Noise Levels at Noise Measurement Site LT-4
Northwest Corner of Lemon Street and 3rd Street
Sunday, September 22, 2013**

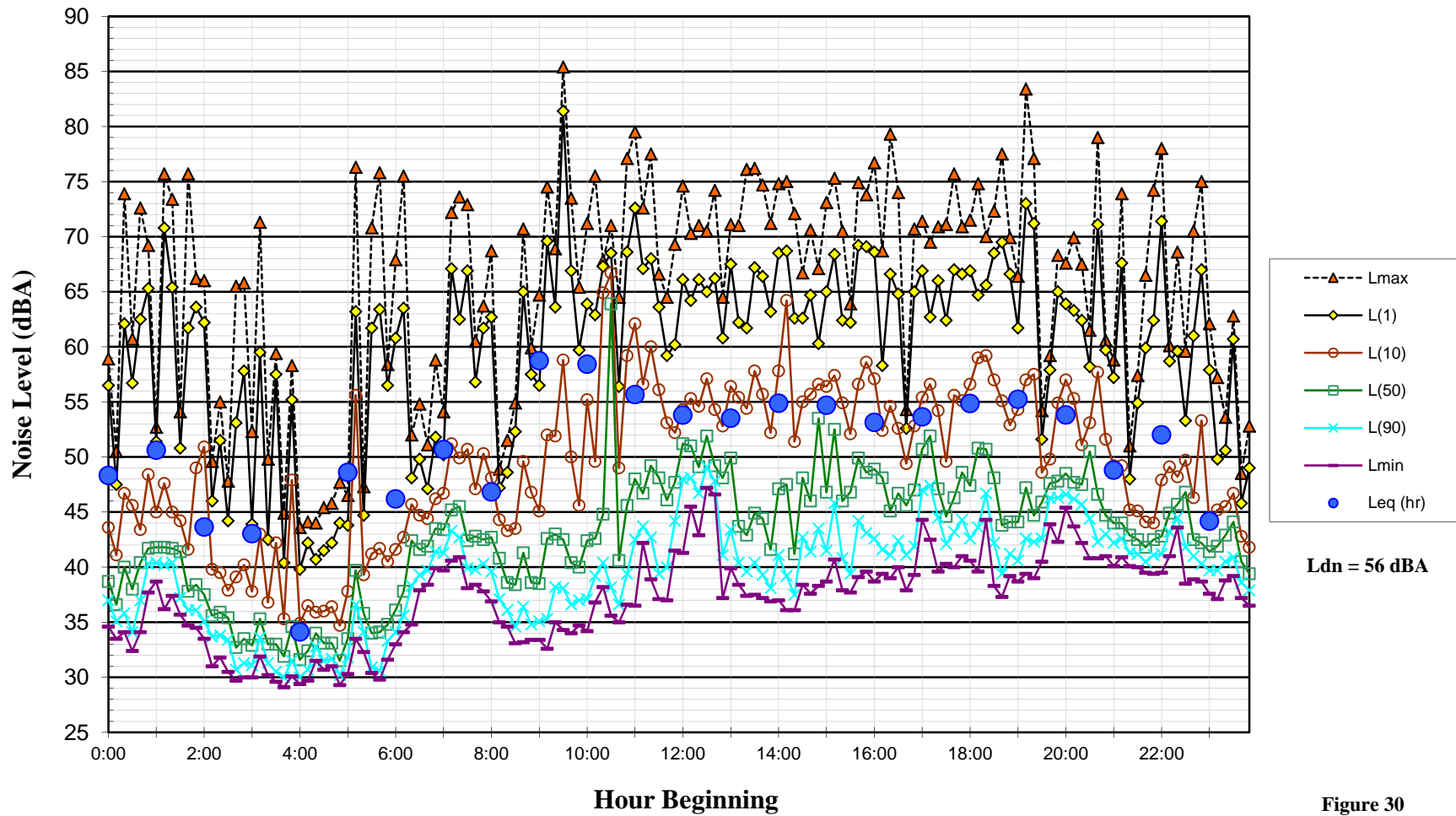

Figure 30

**Noise Levels at Noise Measurement Site LT-4
Northwest Corner of Lemon Street and 3rd Street
Monday, September 23, 2013**

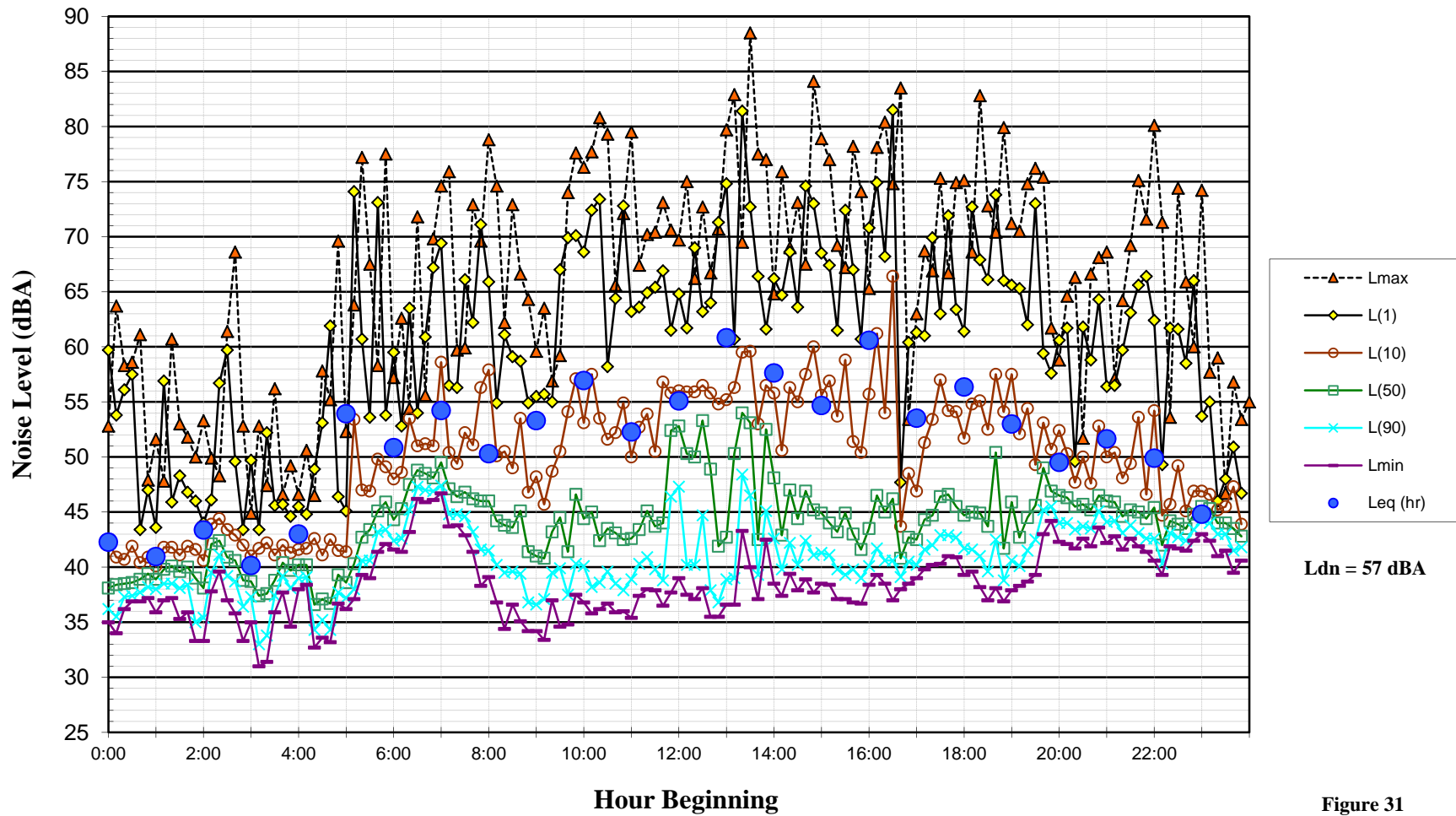

Figure 31

**Noise Levels at Noise Measurement Site LT-4
Northwest Corner of Lemon Street and 3rd Street
Tuesday, September 24, 2013**

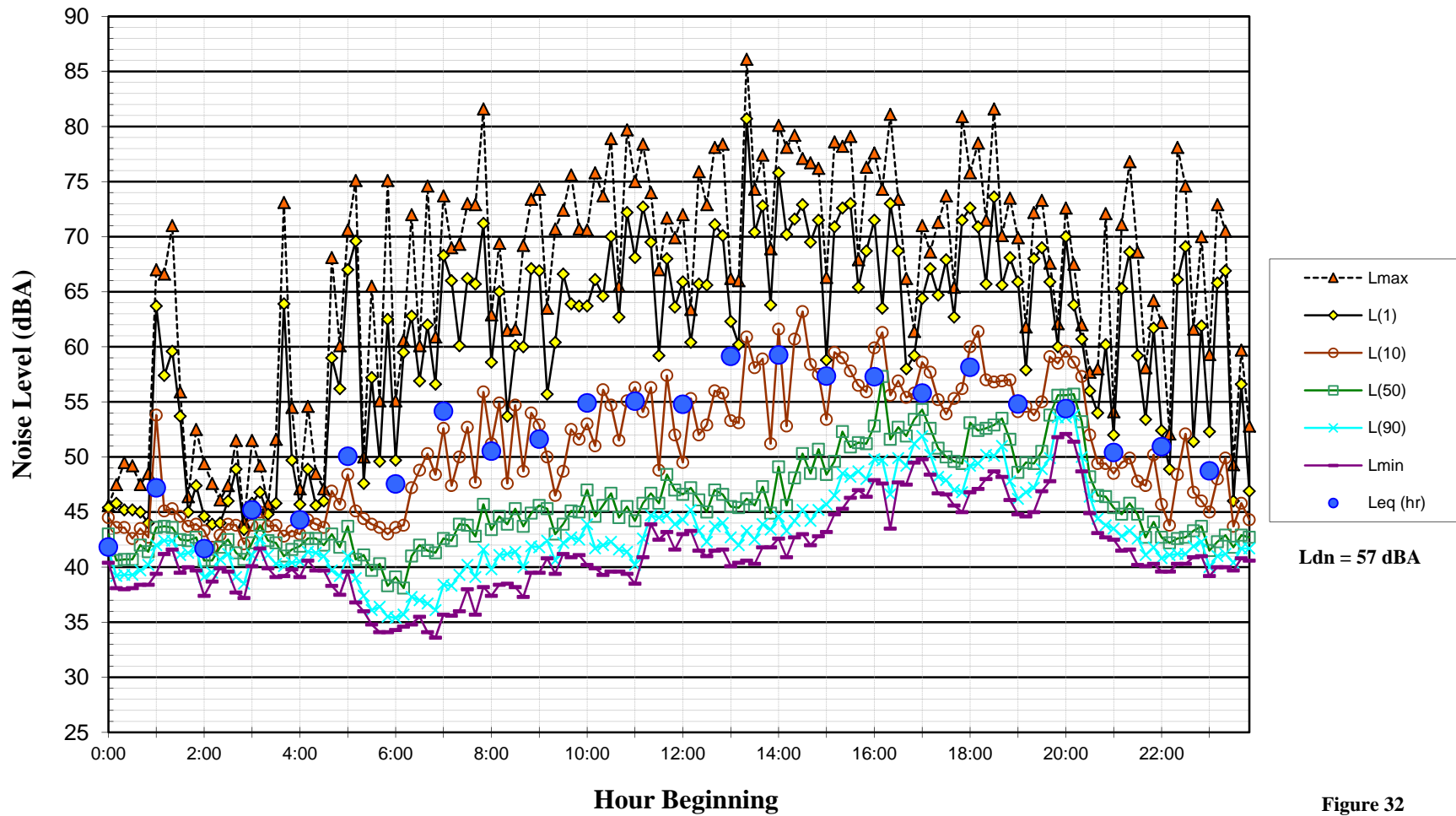

Figure 32

**Noise Levels at Noise Measurement Site LT-4
Northwest Corner of Lemon Street and 3rd Street
Wednesday, September 25, 2013**

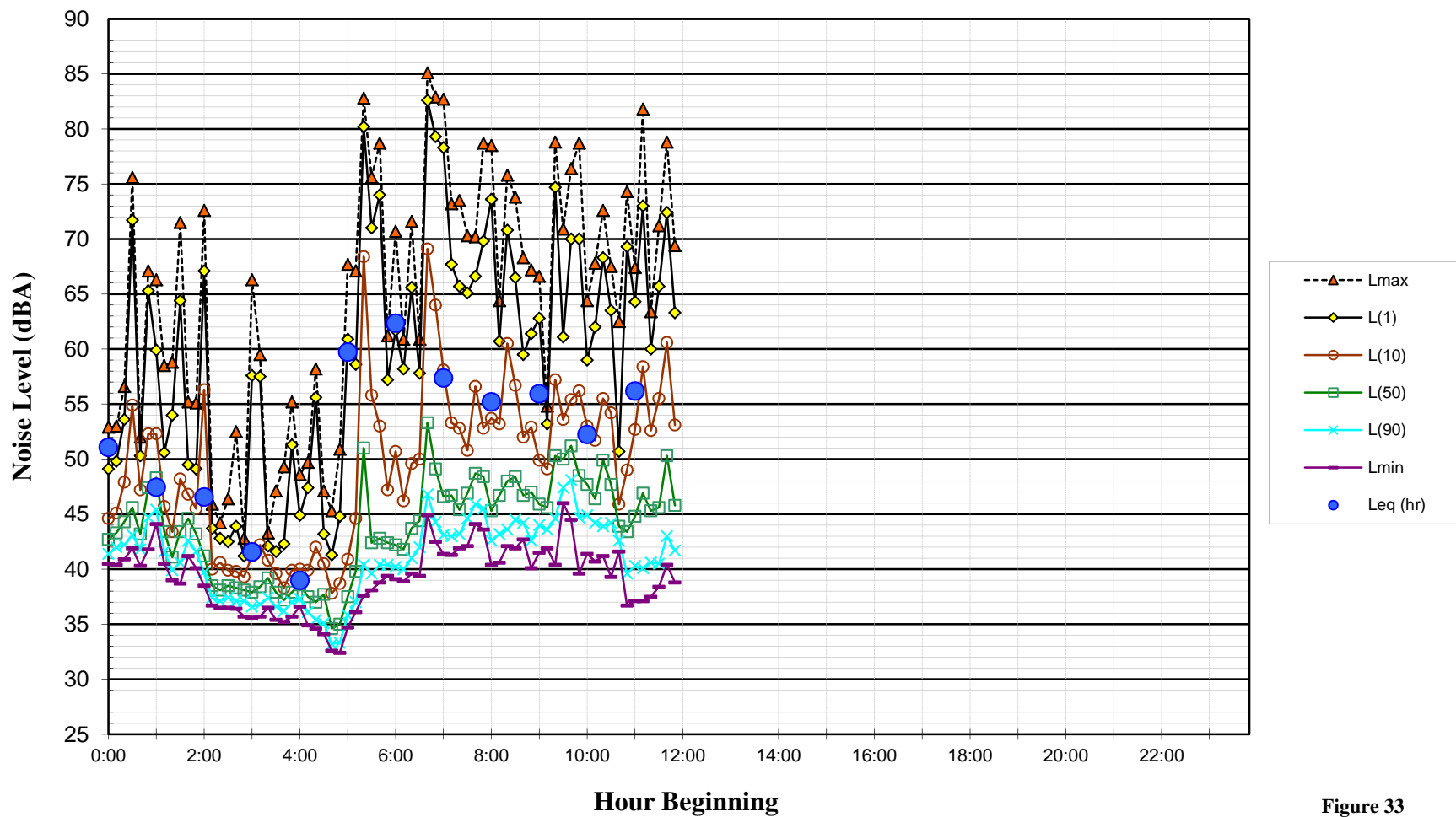

Figure 33

Noise Levels at Noise Measurement Site LT-5
Norman C. King Community Center, 27 m from the Centerline of Sonoma Boulevard
Wednesday, September 18, 2013

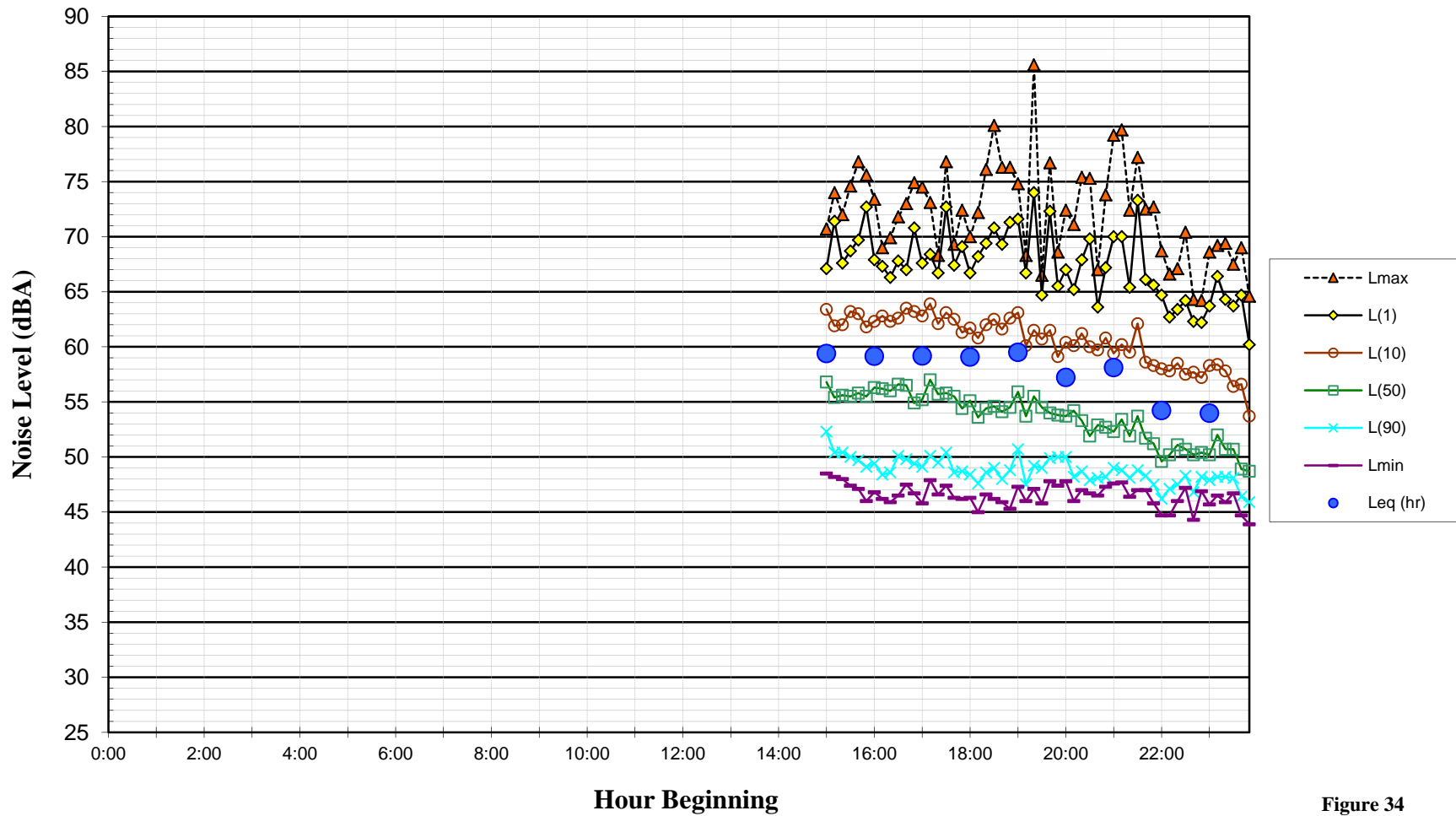

Figure 34

Noise Levels at Noise Measurement Site LT-5
Norman C. King Community Center, 27 m from the Centerline of Sonoma Boulevard
Thursday, September 19, 2013

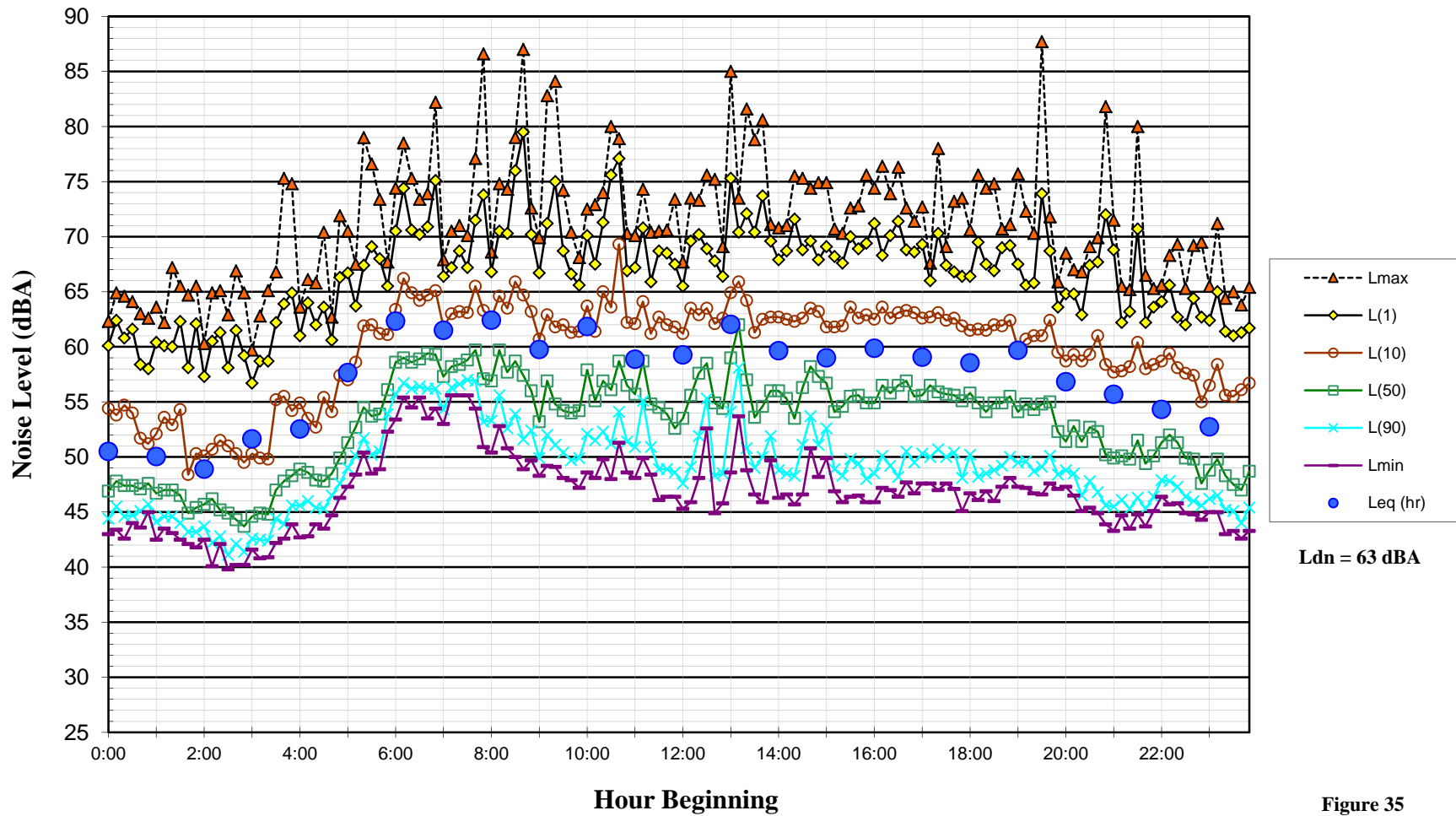

Figure 35

Noise Levels at Noise Measurement Site LT-5
Norman C. King Community Center, 27 m from the Centerline of Sonoma Boulevard
Friday, September 20, 2013

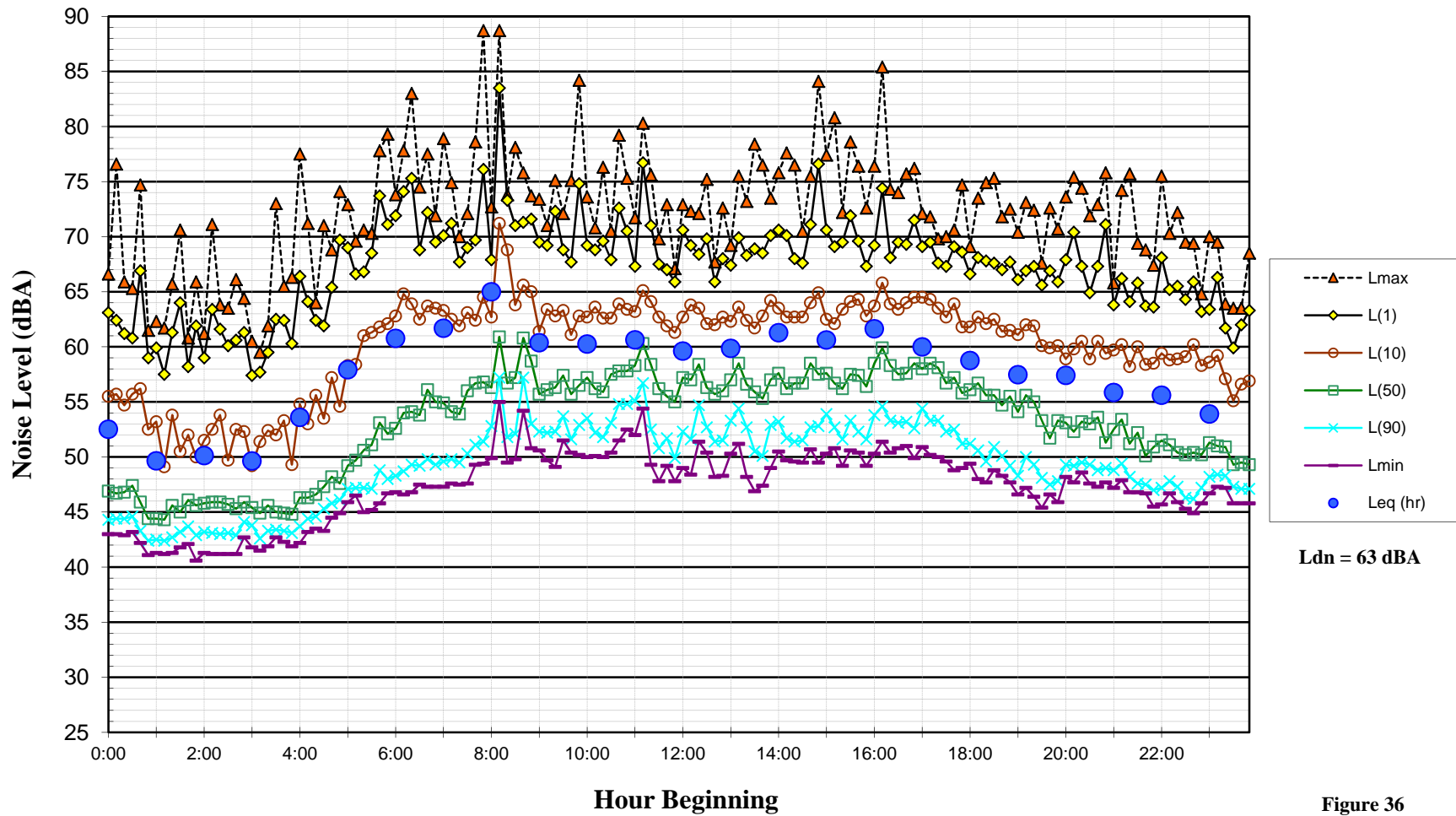

Figure 36

Noise Levels at Noise Measurement Site LT-5
Norman C. King Community Center, 27 m from the Centerline of Sonoma Boulevard
Saturday, September 21, 2013

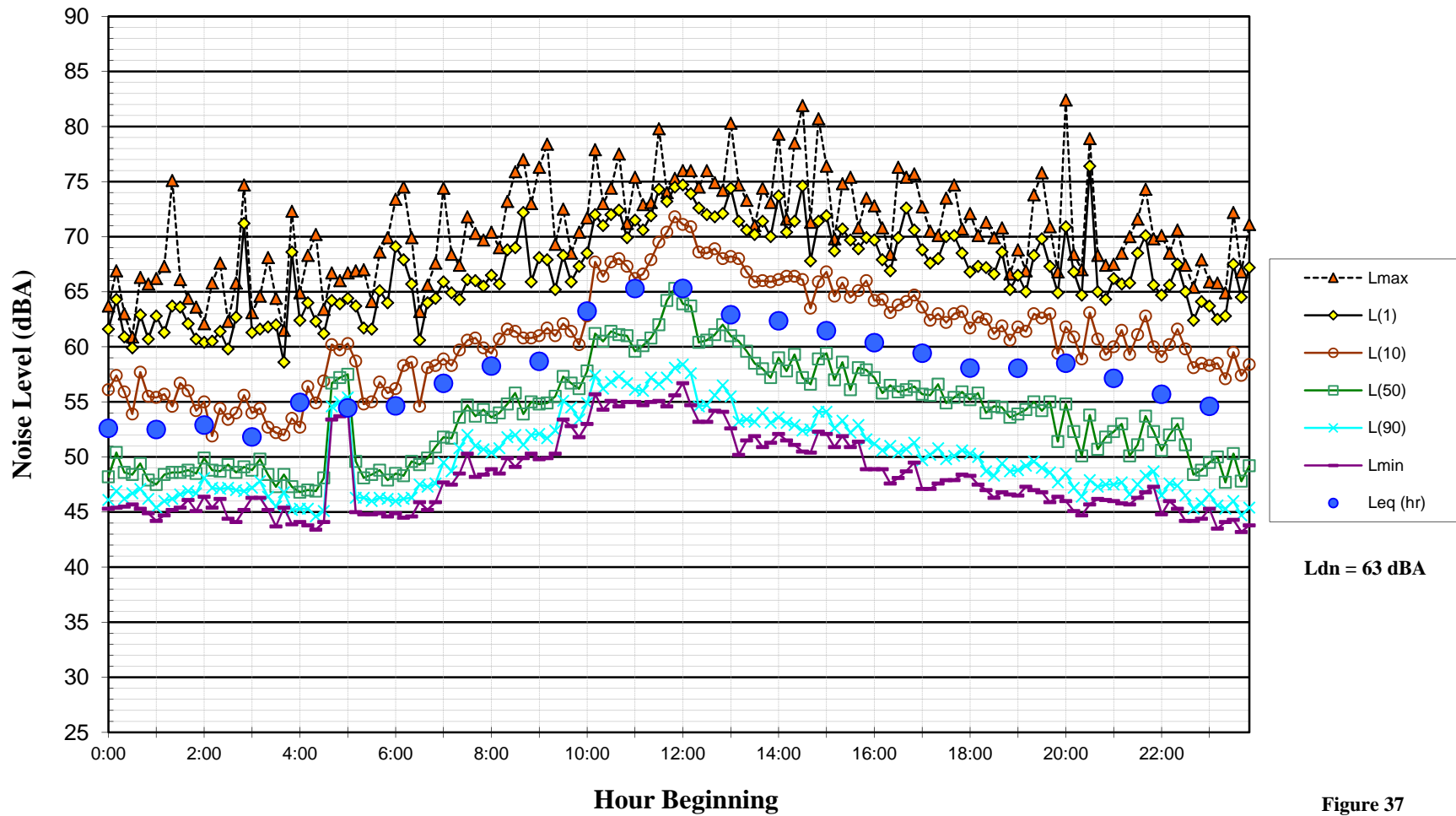

Figure 37

Noise Levels at Noise Measurement Site LT-5
Norman C. King Community Center, 27 m from the Centerline of Sonoma Boulevard
Sunday, September 22, 2013

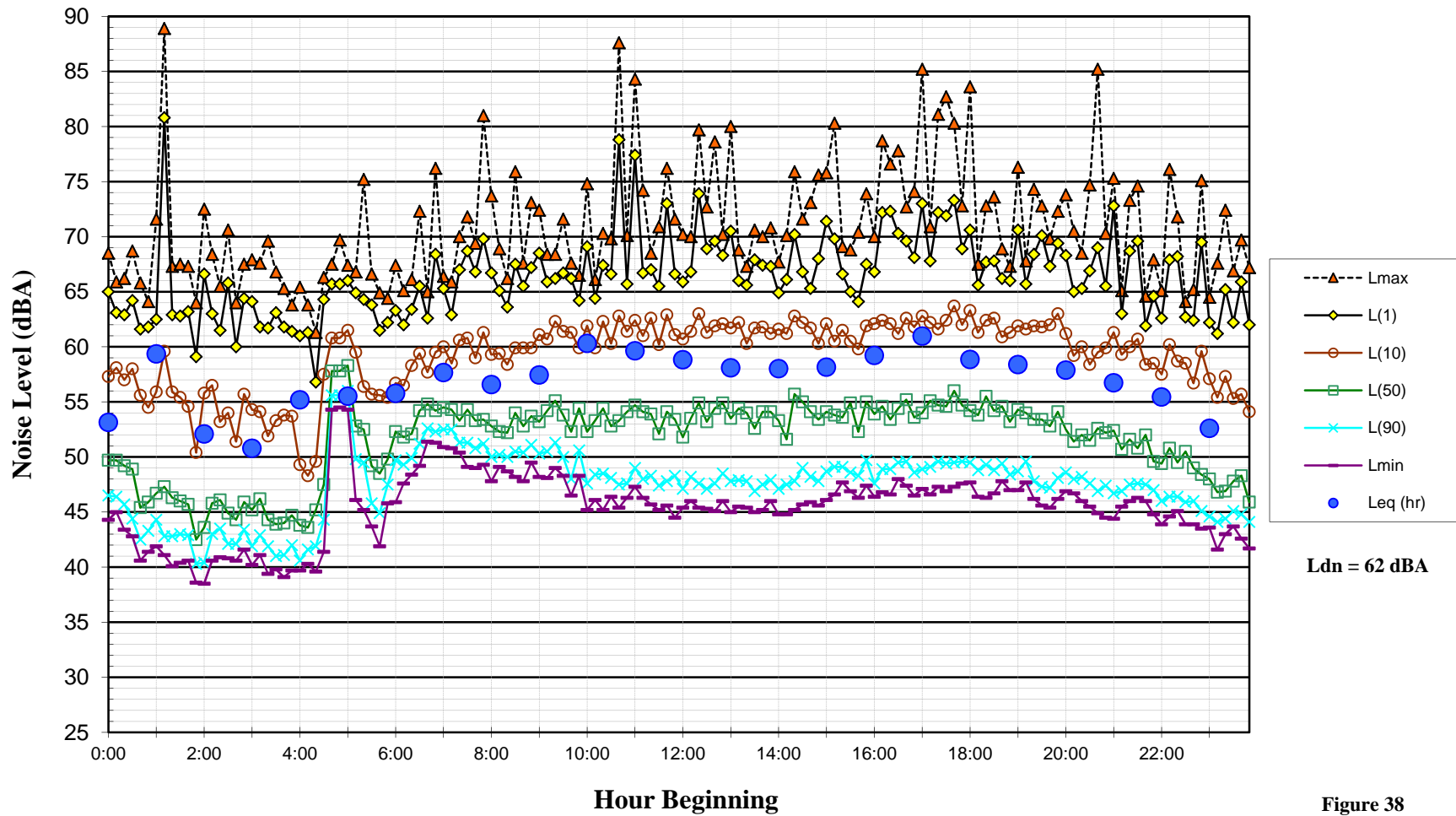

Figure 38

Noise Levels at Noise Measurement Site LT-5
Norman C. King Community Center, 27 m from the Centerline of Sonoma Boulevard
Monday, September 23, 2013

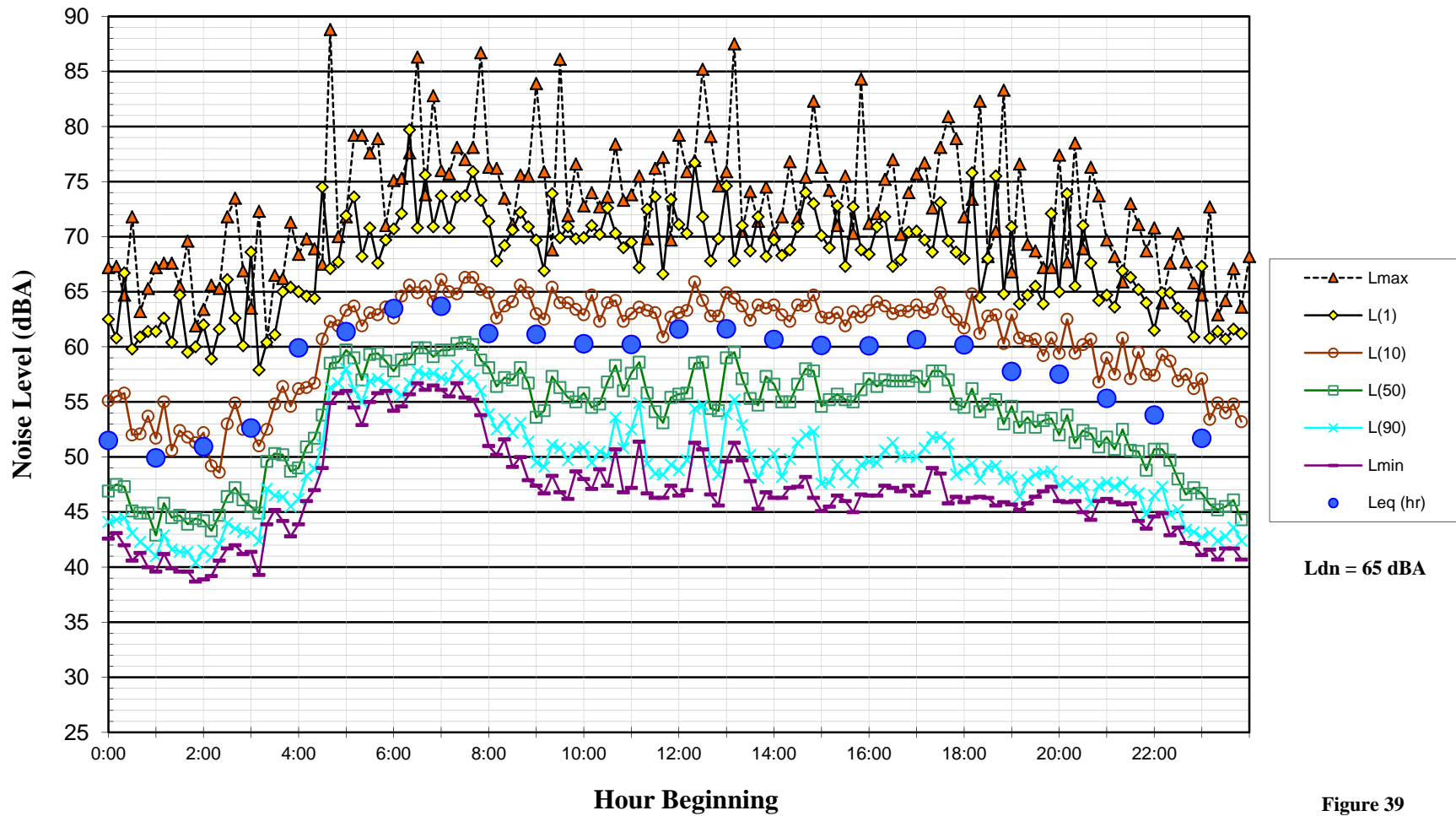

Figure 39

Noise Levels at Noise Measurement Site LT-5
Norman C. King Community Center, 27 m from the Centerline of Sonoma Boulevard
Tuesday, September 24, 2013

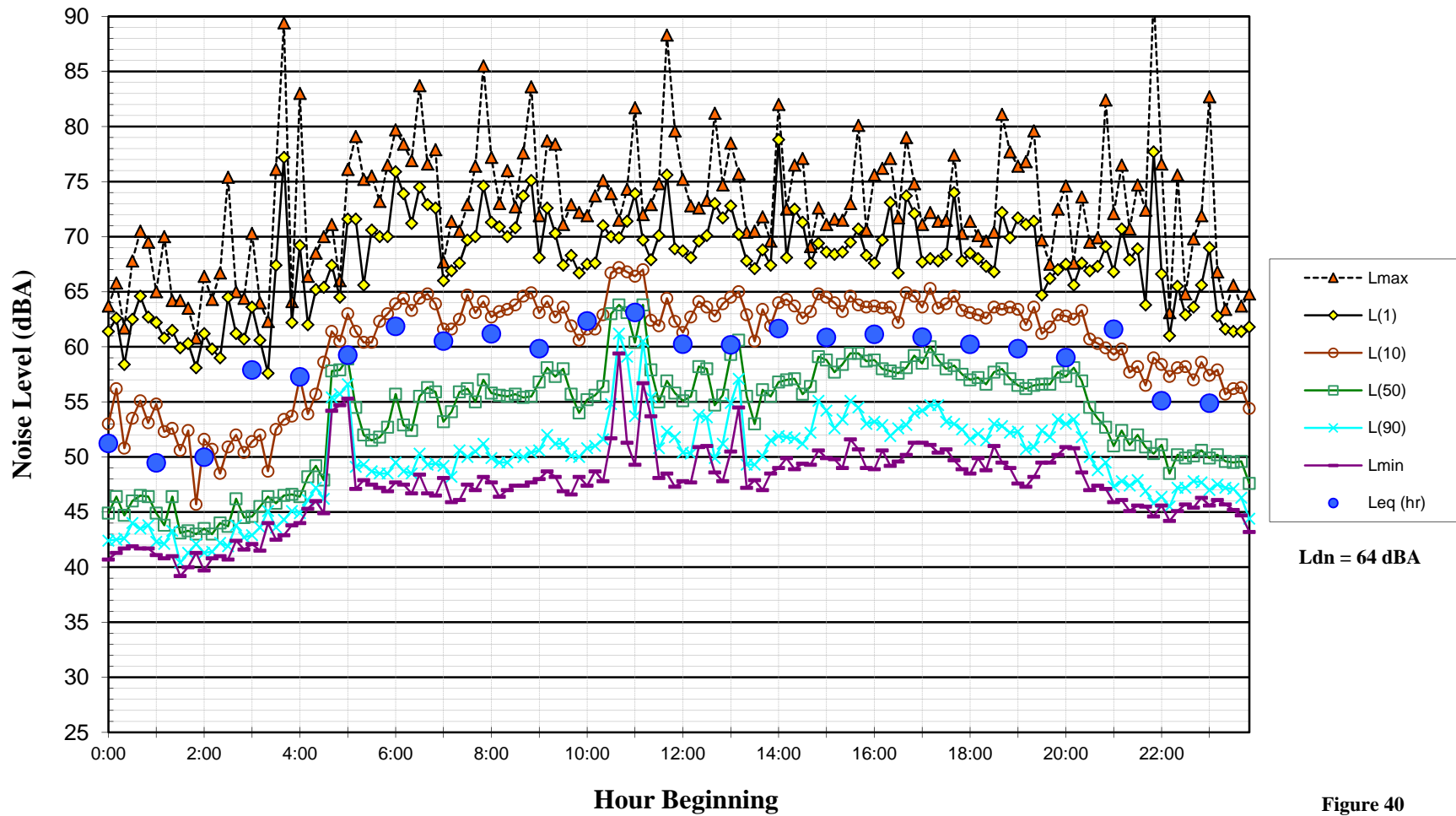

Figure 40

Noise Levels at Noise Measurement Site LT-5
Norman C. King Community Center, 27 m from the Centerline of Sonoma Boulevard
Wednesday, September 25, 2013

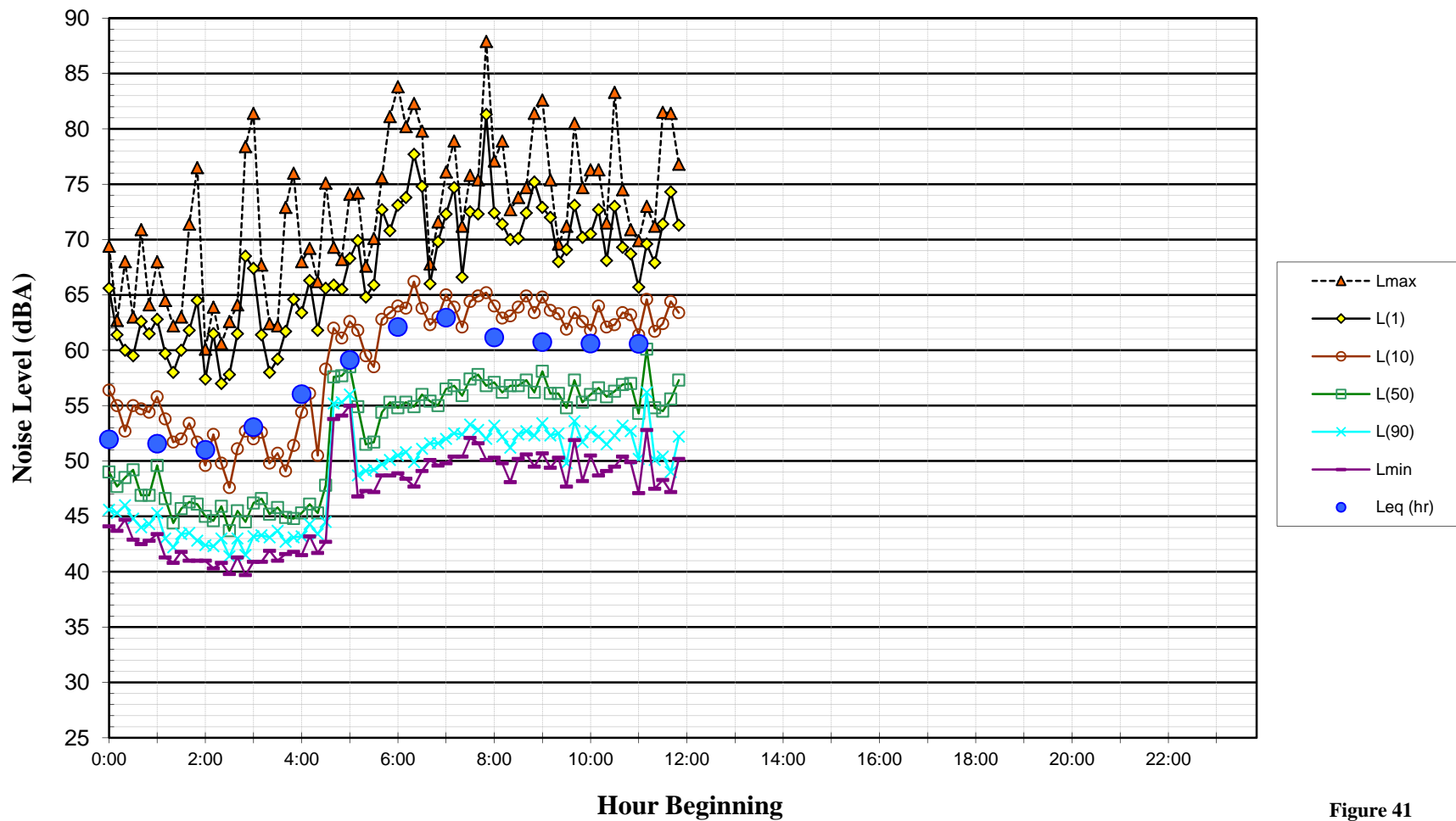

Figure 41

APPENDIX C
Metrological Data During Noise Survey

Weather History for Napa County, CA

Wednesday, September 18, 2013

Wednesday, September 18, 2013

« Previous Day

September ▾

18 ▾

2013 ▾

View

Next Day »

Daily

Weekly

Monthly

Custom

	Actual	Average	Record
Temperature			
Mean Temperature	66 °F	64 °F	
Max Temperature	85 °F	80 °F	97 °F (2000)
Min Temperature	47 °F	49 °F	38 °F (2008)
Degree Days			
Heating Degree Days	0		
Month to date heating degree days	1		
Since 1 July heating degree days	37		
Cooling Degree Days	1		
Month to date cooling degree days	58		
Year to date cooling degree days	295		
Growing Degree Days	16 (Base 50)		
Moisture			
Dew Point	47 °F		
Average Humidity	58		
Maximum Humidity	93		
Minimum Humidity	23		
Precipitation			
Precipitation	0.00 in	-	1.87 in (1959)
Month to date precipitation	0.00		
Year to date precipitation	1.97		
Since 1 July precipitation	0.00		
Sea Level Pressure			
Sea Level Pressure	29.83 in		
Wind			
Wind Speed	6 mph (SSW)		
Max Wind Speed	18 mph		
Max Gust Speed	23 mph		
Visibility	10 miles		
Events			

T = Trace of Precipitation, MM = Missing Value

Source: NWS Daily Summary

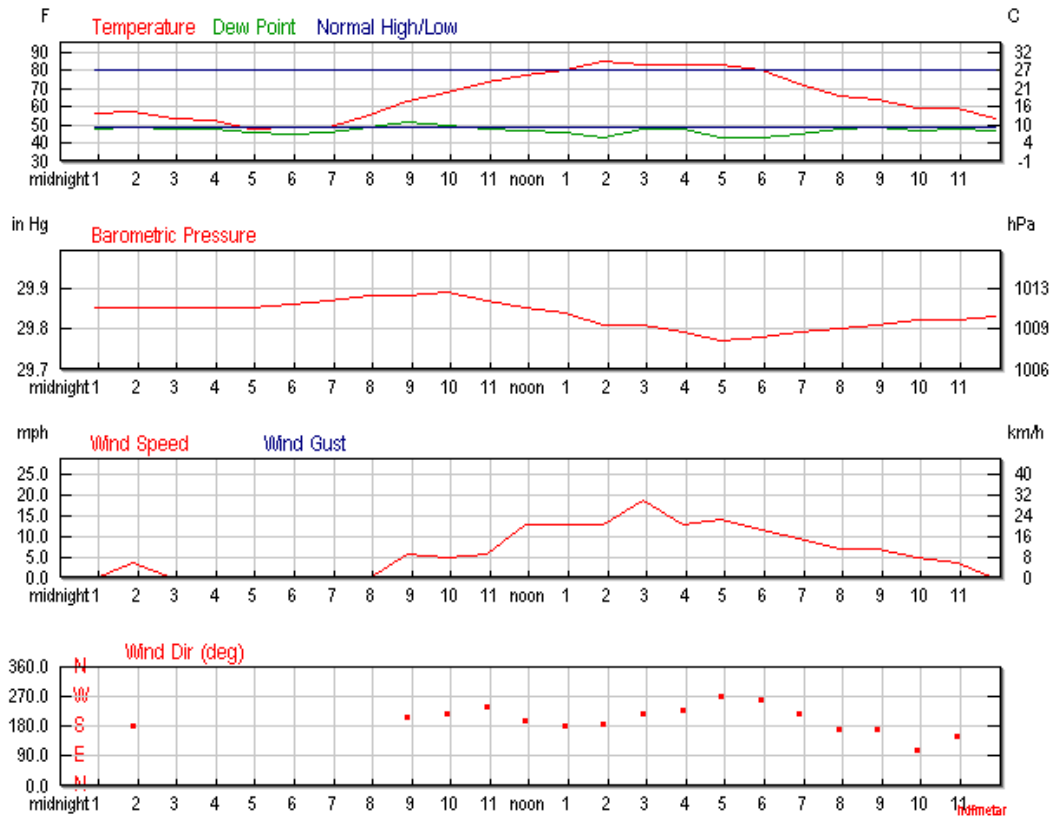

[Certify This Report](#)

Hourly Weather History & Observations

Time (PDT)	Temp.	Dew Point	Humidity	Pressure	Visibility	Wind Dir	Wind Speed	Gust Speed	Precip	Events	Conditions
12:54 AM	55.9 °F	48.0 °F	75%	29.85 in	10.0 mi	Calm	Calm	-	N/A		Clear
1:54 AM	57.0 °F	48.9 °F	74%	29.85 in	10.0 mi	South	3.5 mph	-	N/A		Clear
2:54 AM	53.1 °F	48.0 °F	83%	29.85 in	10.0 mi	Calm	Calm	-	N/A		Clear
3:54 AM	52.0 °F	48.0 °F	86%	29.85 in	10.0 mi	Calm	Calm	-	N/A		Clear
4:54 AM	48.0 °F	46.0 °F	93%	29.85 in	10.0 mi	Calm	Calm	-	N/A		Clear
5:54 AM	48.9 °F	45.0 °F	86%	29.86 in	10.0 mi	Calm	Calm	-	N/A		Clear
6:54 AM	48.9 °F	46.0 °F	90%	29.87 in	10.0 mi	Calm	Calm	-	N/A		Clear
7:54 AM	55.0 °F	48.9 °F	80%	29.88 in	10.0 mi	Calm	Calm	-	N/A		Clear
8:54 AM	63.0 °F	51.1 °F	65%	29.88 in	10.0 mi	SSW	5.8 mph	-	N/A		Clear
9:54 AM	68.0 °F	50.0 °F	52%	29.89 in	10.0 mi	SW	4.6 mph	-	N/A		Clear
10:54 AM	73.0 °F	48.0 °F	41%	29.87 in	10.0 mi	WSW	5.8 mph	-	N/A		Clear
11:54 AM	77.0 °F	46.9 °F	34%	29.85 in	10.0 mi	SSW	12.7 mph	-	N/A		Clear
12:54 PM	80.1 °F	46.0 °F	30%	29.84 in	10.0 mi	South	12.7 mph	-	N/A		Clear
1:54 PM	84.9 °F	43.0 °F	23%	29.81 in	10.0 mi	South	12.7 mph	-	N/A		Clear
2:54 PM	82.9 °F	48.0 °F	29%	29.81 in	10.0 mi	SW	18.4 mph	-	N/A		Clear
3:54 PM	82.9 °F	48.0 °F	29%	29.79 in	10.0 mi	SW	12.7 mph	-	N/A		Clear

10/1/13

Weather History for Napa County, CA | Weather Underground

4:54 PM	82.9 °F	43.0 °F	24%	29.77 in	10.0 mi	West	13.8 mph	-	N/A	Clear
5:54 PM	80.1 °F	43.0 °F	27%	29.78 in	10.0 mi	West	11.5 mph	-	N/A	Clear
6:54 PM	72.0 °F	45.0 °F	38%	29.79 in	10.0 mi	SW	9.2 mph	-	N/A	Clear
7:54 PM	66.0 °F	48.0 °F	52%	29.80 in	10.0 mi	South	6.9 mph	-	N/A	Clear
8:54 PM	64.0 °F	48.9 °F	58%	29.81 in	10.0 mi	South	6.9 mph	-	N/A	Clear
9:54 PM	59.0 °F	46.9 °F	64%	29.82 in	10.0 mi	ESE	4.6 mph	-	N/A	Clear
10:54 PM	59.0 °F	48.0 °F	67%	29.82 in	10.0 mi	SSE	3.5 mph	-	N/A	Clear
11:54 PM	53.1 °F	46.9 °F	80%	29.83 in	10.0 mi	Calm	Calm	-	N/A	Clear

[Show full METARS](#) | [METAR FAQ](#) | [Comma Delimited File](#)

Weather History for Napa County, CA

Thursday, September 19, 2013

Thursday, September 19, 2013

[« Previous Day](#)

September 19 2013 [View](#)

[Next Day »](#)

- Daily
- Weekly
- Monthly
- Custom

	Actual	Average	Record
Temperature			
Mean Temperature	67 °F	64 °F	
Max Temperature	88 °F	80 °F	97 °F (2002)
Min Temperature	45 °F	49 °F	41 °F (2008)
Degree Days			
Heating Degree Days	0		
Month to date heating degree days	1		
Since 1 July heating degree days	37		
Cooling Degree Days	2		
Month to date cooling degree days	60		
Year to date cooling degree days	297		
Growing Degree Days	16 (Base 50)		
Moisture			
Dew Point	48 °F		
Average Humidity	56		
Maximum Humidity	93		
Minimum Humidity	19		
Precipitation			
Precipitation	0.00 in	-	0.51 in (1977)
Month to date precipitation	0.00		
Year to date precipitation	1.97		
Since 1 July precipitation	0.00		
Sea Level Pressure			
Sea Level Pressure	29.79 in		
Wind			
Wind Speed	5 mph (SSW)		
Max Wind Speed	14 mph		
Max Gust Speed	16 mph		
Visibility	10 miles		
Events			

T = Trace of Precipitation, MM = Missing Value

Source: NWS Daily Summary

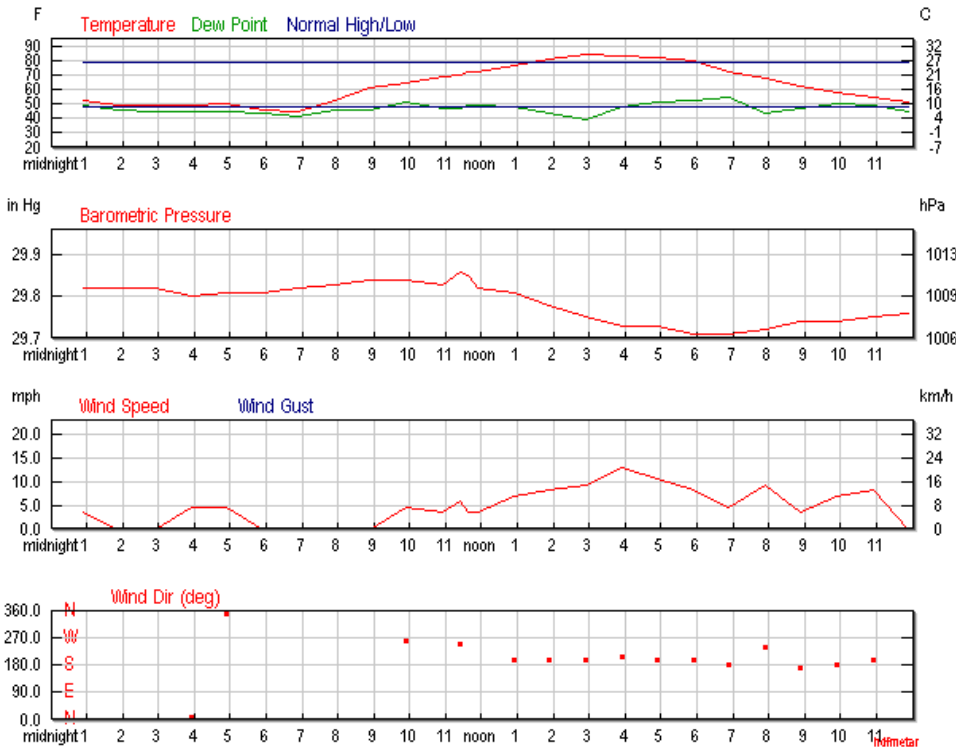

Certify This Report



Hourly Weather History & Observations

Time (PDT)	Temp.	Heat Index	Dew Point	Humidity	Pressure	Visibility	Wind Dir	Wind Speed	Gust Speed	Precip	Events	Conditions
12:54 AM	54.0 °F	-	50.0 °F	86%	29.82 in	10.0 mi	SSE	3.5 mph	-	N/A		Clear
1:54 AM	50.0 °F	-	46.9 °F	89%	29.82 in	10.0 mi	Calm	Calm	-	N/A		Clear
2:54 AM	50.0 °F	-	46.0 °F	86%	29.82 in	10.0 mi	Calm	Calm	-	N/A		Clear
3:54 AM	50.0 °F	-	46.0 °F	86%	29.80 in	10.0 mi	North	4.6 mph	-	N/A		Clear
4:54 AM	51.1 °F	-	46.0 °F	83%	29.81 in	10.0 mi	North	4.6 mph	-	N/A		Clear
5:54 AM	46.9 °F	-	44.1 °F	90%	29.81 in	10.0 mi	Calm	Calm	-	N/A		Clear
6:54 AM	46.0 °F	-	42.1 °F	86%	29.82 in	10.0 mi	Calm	Calm	-	N/A		Clear
7:54 AM	53.1 °F	-	46.9 °F	80%	29.83 in	10.0 mi	Calm	Calm	-	N/A		Clear
8:54 AM	62.1 °F	-	46.9 °F	58%	29.84 in	10.0 mi	Calm	Calm	-	N/A		Clear
9:54 AM	66.0 °F	-	52.0 °F	60%	29.84 in	10.0 mi	West	4.6 mph	-	N/A		Clear
10:54 AM	70.0 °F	-	48.0 °F	46%	29.83 in	10.0 mi	Variable	3.5 mph	-	N/A		Clear
11:23 AM	71.6 °F	-	48.2 °F	43%	29.86 in	2.5 mi	WSW	5.8 mph	-	N/A		Haze
11:38 AM	73.4 °F	-	50.0 °F	44%	29.85 in	10.0 mi	Variable	3.5 mph	-	N/A		Clear
11:54 AM	73.0 °F	-	50.0 °F	44%	29.82 in	10.0 mi	Variable	3.5 mph	-	N/A		Clear
12:54 PM	78.1 °F	-	48.9 °F	36%	29.81 in	10.0 mi	SSW	6.9 mph	-	N/A		Clear
1:54 PM	82.0 °F	-	45.0 °F	27%	29.78 in	10.0 mi	SSW	8.1 mph	-	N/A		Clear
2:54 PM	86.0 °F	-	39.9 °F	20%	29.75 in	10.0 mi	SSW	9.2 mph	-	N/A		Clear

3:54 PM	84.9 °F	-	48.9 °F	29%	29.73 in	10.0 mi	SSW	12.7 mph	-	N/A	Clear
4:54 PM	82.9 °F	-	52.0 °F	34%	29.73 in	10.0 mi	SSW	10.4 mph	-	N/A	Clear
5:54 PM	81.0 °F	80.4 °F	53.1 °F	38%	29.71 in	10.0 mi	SSW	8.1 mph	-	N/A	Clear
6:54 PM	73.9 °F	-	55.9 °F	53%	29.71 in	10.0 mi	South	4.6 mph	-	N/A	Clear
7:54 PM	69.1 °F	-	44.1 °F	40%	29.72 in	10.0 mi	WSW	9.2 mph	-	N/A	Clear
8:54 PM	63.0 °F	-	48.0 °F	58%	29.74 in	10.0 mi	South	3.5 mph	-	N/A	Clear
9:54 PM	59.0 °F	-	51.1 °F	75%	29.74 in	10.0 mi	South	6.9 mph	-	N/A	Clear
10:54 PM	55.9 °F	-	50.0 °F	80%	29.75 in	10.0 mi	SSW	8.1 mph	-	N/A	Clear
11:54 PM	52.0 °F	-	46.0 °F	80%	29.76 in	10.0 mi	Calm	Calm	-	N/A	Clear

[Show full METARS](#) | [METAR FAQ](#) | [Comma Delimited File](#)

Weather History for Napa County, CA

Friday, September 20, 2013

Friday, September 20, 2013

« Previous Day

September ▾ 20 ▾ 2013 ▾ View

Next Day »

- Daily
- Weekly
- Monthly
- Custom

	Actual	Average	Record
Temperature			
Mean Temperature	61 °F	64 °F	
Max Temperature	80 °F	79 °F	97 °F (2011)
Min Temperature	42 °F	49 °F	38 °F (2004)
Degree Days			
Heating Degree Days	4		
Month to date heating degree days	5		
Since 1 July heating degree days	41		
Cooling Degree Days	0		
Month to date cooling degree days	60		
Year to date cooling degree days	297		
Growing Degree Days	11 (Base 50)		
Moisture			
Dew Point	53 °F		
Average Humidity	73		
Maximum Humidity	100		
Minimum Humidity	45		
Precipitation			
Precipitation	0.00 in	-	0.14 in (1973)
Month to date precipitation	0.00		
Year to date precipitation	1.97		
Since 1 July precipitation	0.00		
Sea Level Pressure			
Sea Level Pressure	29.78 in		
Wind			
Wind Speed	11 mph (SW)		
Max Wind Speed	23 mph		
Max Gust Speed	29 mph		
Visibility	9 miles		
Events			

T = Trace of Precipitation, MM = Missing Value

Source: NWS Daily Summary

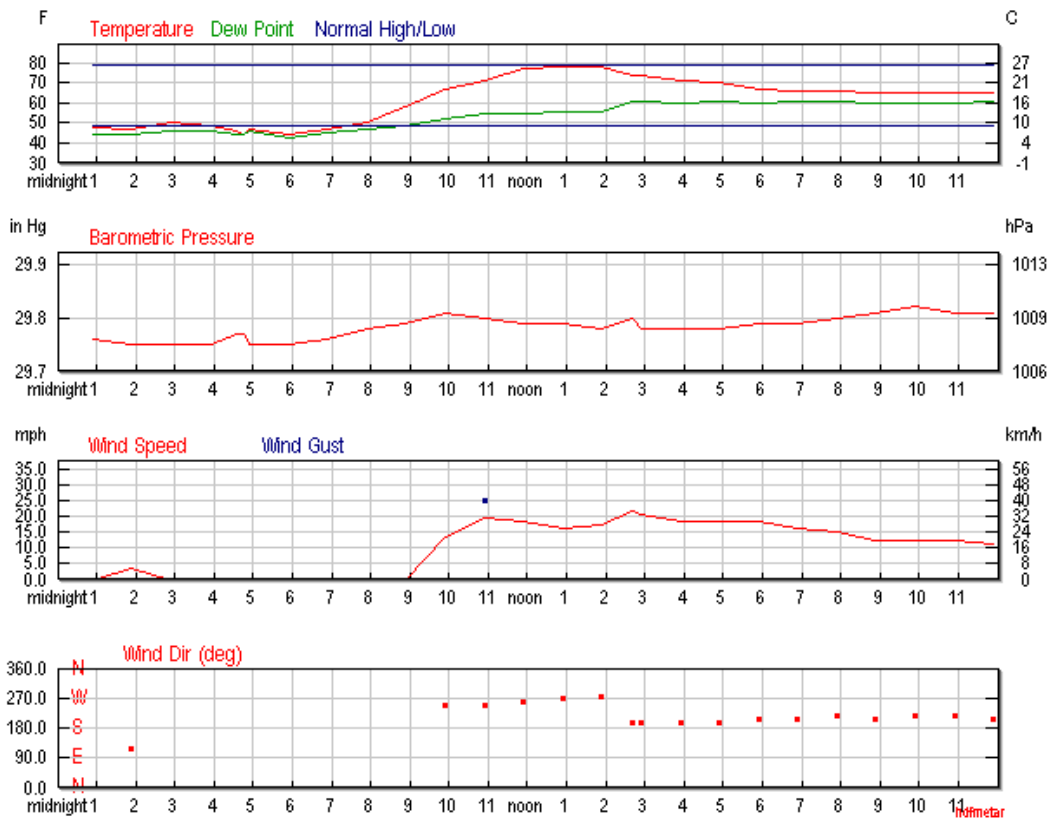

[Certify This Report](#)

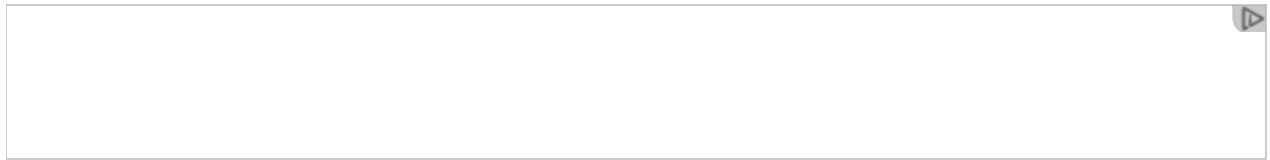

Hourly Weather History & Observations

Time (PDT)	Temp.	Dew Point	Humidity	Pressure	Visibility	Wind Dir	Wind Speed	Gust Speed	Precip	Events	Conditions
12:54 AM	48.0 °F	44.1 °F	86%	29.76 in	10.0 mi	Calm	Calm	-	N/A		Clear
1:54 AM	46.9 °F	44.1 °F	90%	29.75 in	10.0 mi	ESE	3.5 mph	-	N/A		Clear
2:54 AM	50.0 °F	46.0 °F	86%	29.75 in	10.0 mi	Calm	Calm	-	N/A		Clear
3:54 AM	48.9 °F	46.0 °F	90%	29.75 in	10.0 mi	Calm	Calm	-	N/A		Clear
4:36 AM	46.4 °F	44.6 °F	93%	29.77 in	1.8 mi	Calm	Calm	-	N/A		Clear
4:45 AM	44.6 °F	44.6 °F	100%	29.77 in	3.0 mi	Calm	Calm	-	N/A		Clear
4:54 AM	46.9 °F	46.0 °F	97%	29.75 in	10.0 mi	Calm	Calm	-	N/A		Clear
5:54 AM	44.1 °F	43.0 °F	96%	29.75 in	6.0 mi	Calm	Calm	-	N/A		Clear
6:54 AM	46.9 °F	45.0 °F	93%	29.76 in	10.0 mi	Calm	Calm	-	N/A		Clear
7:54 AM	50.0 °F	46.9 °F	89%	29.78 in	10.0 mi	Calm	Calm	-	N/A		Clear
8:54 AM	57.9 °F	48.9 °F	72%	29.79 in	10.0 mi	Calm	Calm	-	N/A		Clear
9:54 AM	66.9 °F	52.0 °F	59%	29.81 in	10.0 mi	WSW	13.8 mph	19.6 mph	N/A		Clear
10:54 AM	71.1 °F	55.0 °F	57%	29.80 in	8.0 mi	WSW	19.6 mph	25.3 mph	N/A		Partly Cloudy

10/1/13

Weather History for Napa County, CA | Weather Underground

11:54 AM	77.0 °F	55.0 °F	47%	29.79 in	10.0 mi	West	18.4 mph	-	N/A	Clear
12:54 PM	78.1 °F	55.9 °F	46%	29.79 in	10.0 mi	West	16.1 mph	27.6 mph	N/A	Clear
1:54 PM	78.1 °F	55.9 °F	46%	29.78 in	10.0 mi	West	17.3 mph	-	N/A	Scattered Clouds
2:42 PM	73.4 °F	60.8 °F	65%	29.80 in	10.0 mi	SSW	21.9 mph	-	N/A	Mostly Cloudy
2:54 PM	73.9 °F	61.0 °F	64%	29.78 in	10.0 mi	SSW	20.7 mph	-	N/A	Mostly Cloudy
3:54 PM	71.1 °F	60.1 °F	68%	29.78 in	10.0 mi	SSW	18.4 mph	-	N/A	Mostly Cloudy
4:54 PM	70.0 °F	61.0 °F	73%	29.78 in	10.0 mi	SSW	18.4 mph	-	N/A	Overcast
5:54 PM	66.9 °F	60.1 °F	79%	29.79 in	10.0 mi	SSW	18.4 mph	-	N/A	Overcast
6:54 PM	66.0 °F	61.0 °F	84%	29.79 in	10.0 mi	SSW	16.1 mph	-	N/A	Overcast
7:54 PM	66.0 °F	61.0 °F	84%	29.80 in	10.0 mi	SW	15.0 mph	-	N/A	Overcast
8:54 PM	64.9 °F	60.1 °F	84%	29.81 in	10.0 mi	SSW	12.7 mph	-	N/A	Mostly Cloudy
9:54 PM	64.9 °F	60.1 °F	84%	29.82 in	10.0 mi	SW	12.7 mph	-	N/A	Overcast
10:54 PM	64.9 °F	60.1 °F	84%	29.81 in	10.0 mi	SW	12.7 mph	-	N/A	Overcast
11:54 PM	64.9 °F	61.0 °F	87%	29.81 in	10.0 mi	SSW	11.5 mph	-	N/A	Overcast

[Show full METARS](#) | [METAR FAQ](#) | [Comma Delimited File](#)

Weather History for Napa County, CA

Saturday, September 21, 2013

Saturday, September 21, 2013

« Previous Day

September ▾

21 ▾

2013 ▾

View

Next Day »

Daily

Weekly

Monthly

Custom

	Actual	Average	Record
Temperature			
Mean Temperature	62 °F	64 °F	
Max Temperature	71 °F	79 °F	102 °F (2003)
Min Temperature	53 °F	48 °F	41 °F (2012)
Degree Days			
Heating Degree Days	3		
Month to date heating degree days	8		
Since 1 July heating degree days	44		
Cooling Degree Days	0		
Month to date cooling degree days	60		
Year to date cooling degree days	297		
Growing Degree Days	12 (Base 50)		
Moisture			
Dew Point	59 °F		
Average Humidity	79		
Maximum Humidity	100		
Minimum Humidity	57		
Precipitation			
Precipitation	0.82 in	-	0.82 in (2013)
Month to date precipitation	0.82		
Year to date precipitation	2.79		
Since 1 July precipitation	0.82		
Sea Level Pressure			
Sea Level Pressure	29.81 in		
Wind			
Wind Speed	11 mph (SW)		
Max Wind Speed	22 mph		
Max Gust Speed	25 mph		
Visibility	8 miles		
Events	Fog , Rain		

T = Trace of Precipitation, MM = Missing Value

Source: NWS Daily Summary

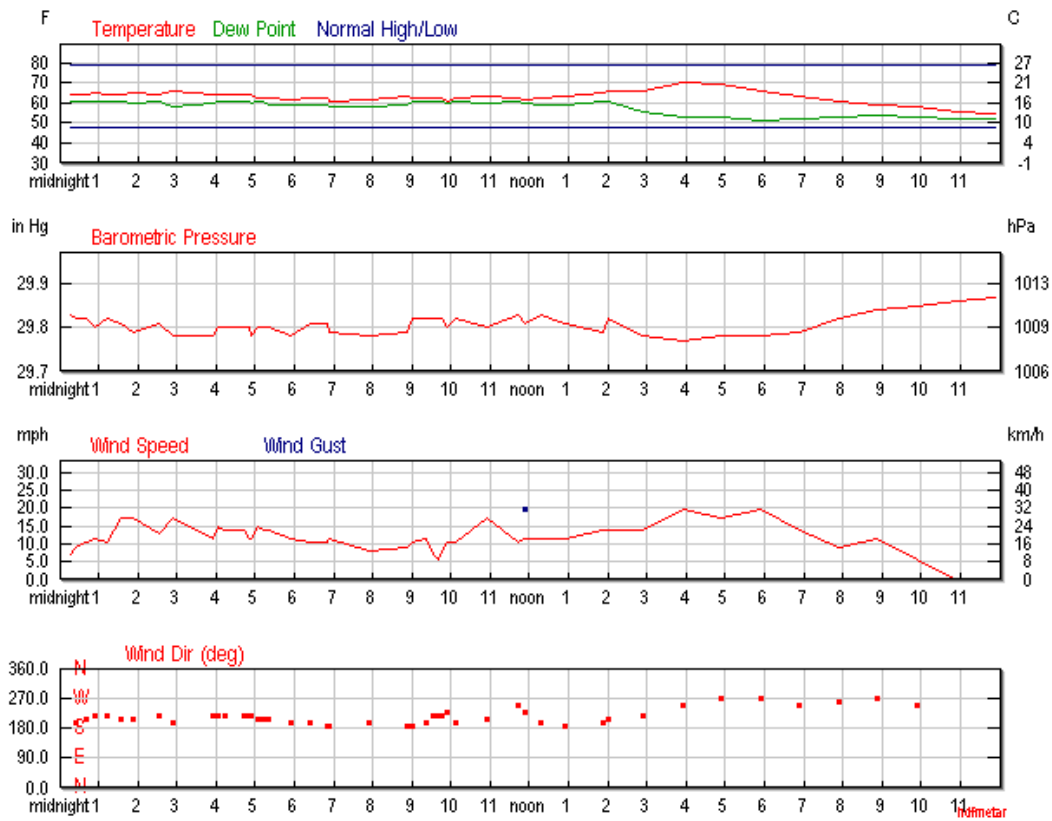

[Certify This Report](#)



Hourly Weather History & Observations

Time (PDT)	Temp.	Dew Point	Humidity	Pressure	Visibility	Wind Dir	Wind Speed	Gust Speed	Precip	Events	Conditions
12:18 AM	64.4 °F	60.8 °F	88%	29.83 in	10.0 mi	SW	6.9 mph	-	N/A		Overcast
12:25 AM	64.4 °F	60.8 °F	88%	29.82 in	10.0 mi	SSW	9.2 mph	-	N/A		Overcast
12:40 AM	64.4 °F	60.8 °F	88%	29.82 in	10.0 mi	SSW	10.4 mph	-	N/A		Overcast
12:54 AM	64.9 °F	61.0 °F	87%	29.80 in	10.0 mi	SW	11.5 mph	-	N/A		Overcast
1:12 AM	64.4 °F	60.8 °F	88%	29.82 in	10.0 mi	SW	10.4 mph	-	N/A		Overcast
1:33 AM	64.4 °F	60.8 °F	88%	29.81 in	10.0 mi	SSW	17.3 mph	-	N/A		Scattered Clouds
1:54 AM	64.9 °F	60.1 °F	84%	29.79 in	10.0 mi	SSW	17.3 mph	-	N/A		Mostly Cloudy
2:33 AM	64.4 °F	60.8 °F	88%	29.81 in	10.0 mi	SW	12.7 mph	-	N/A		Overcast
2:54 AM	66.0 °F	57.9 °F	75%	29.78 in	10.0 mi	SSW	17.3 mph	23.0 mph	N/A		Overcast
3:54 AM	64.0 °F	60.1 °F	87%	29.78 in	10.0 mi	SW	11.5 mph	-	0.00 in		Overcast
4:02 AM	64.4 °F	60.8 °F	88%	29.80 in	10.0 mi	SW	15.0 mph	-	0.00 in	Rain	Light Rain
4:13 AM	64.4 °F	60.8 °F	88%	29.80 in	10.0 mi	SW	13.8 mph	-	0.00 in		Overcast

4:43 AM	64.4 °F	60.8 °F	88%	29.80 in	10.0 mi	SW	13.8 mph	-	0.00 in		Overcast
4:52 AM	64.4 °F	60.8 °F	88%	29.80 in	10.0 mi	SW	11.5 mph	-	0.00 in		Overcast
4:54 AM	64.0 °F	60.1 °F	87%	29.78 in	10.0 mi	SW	11.5 mph	-	0.00 in		Overcast
5:05 AM	62.6 °F	60.8 °F	94%	29.80 in	10.0 mi	SSW	15.0 mph	-	N/A		Overcast
5:12 AM	62.6 °F	60.8 °F	94%	29.80 in	10.0 mi	SSW	13.8 mph	-	N/A		Overcast
5:19 AM	62.6 °F	59.0 °F	88%	29.80 in	10.0 mi	SSW	13.8 mph	-	N/A		Overcast
5:54 AM	62.1 °F	59.0 °F	90%	29.78 in	10.0 mi	SSW	11.5 mph	-	N/A		Scattered Clouds
6:25 AM	62.6 °F	59.0 °F	88%	29.81 in	10.0 mi	SSW	10.4 mph	-	N/A		Mostly Cloudy
6:50 AM	62.6 °F	59.0 °F	88%	29.81 in	10.0 mi	South	10.4 mph	-	N/A		Overcast
6:54 AM	61.0 °F	57.9 °F	90%	29.79 in	10.0 mi	South	11.5 mph	-	N/A		Mostly Cloudy
7:54 AM	62.1 °F	57.9 °F	86%	29.78 in	10.0 mi	SSW	8.1 mph	-	N/A		Mostly Cloudy
8:54 AM	63.0 °F	59.0 °F	87%	29.79 in	5.0 mi	South	9.2 mph	-	0.03 in	Rain	Light Rain
9:01 AM	62.6 °F	60.8 °F	94%	29.82 in	8.0 mi	South	10.4 mph	-	0.00 in	Rain	Light Rain
9:22 AM	62.6 °F	60.8 °F	94%	29.82 in	2.0 mi	SSW	11.5 mph	-	0.03 in	Rain	Rain
9:33 AM	62.6 °F	60.8 °F	94%	29.82 in	1.8 mi	SW	6.9 mph	-	0.10 in	Rain	Rain
9:40 AM	62.6 °F	60.8 °F	94%	29.82 in	1.2 mi	SW	5.8 mph	-	0.14 in	Rain	Heavy Rain
9:47 AM	62.6 °F	60.8 °F	94%	29.82 in	0.5 mi	SW	8.1 mph	-	0.34 in	Fog , Rain	Heavy Rain
9:54 AM	61.0 °F	60.1 °F	97%	29.80 in	0.2 mi	SW	10.4 mph	17.3 mph	0.61 in	Fog , Rain	Heavy Rain
10:06 AM	62.6 °F	60.8 °F	94%	29.82 in	4.0 mi	SSW	10.4 mph	-	0.03 in	Rain	Rain
10:54 AM	63.0 °F	60.1 °F	90%	29.80 in	5.0 mi	SSW	17.3 mph	-	0.09 in	Rain	Rain
11:44 AM	62.6 °F	60.8 °F	94%	29.83 in	2.5 mi	WSW	10.4 mph	19.6 mph	0.06 in	Rain	Heavy Rain
11:54 AM	62.1 °F	60.1 °F	93%	29.81 in	3.0 mi	SW	11.5 mph	19.6 mph	0.08 in	Rain	Heavy Rain
12:17 PM	62.6 °F	59.0 °F	88%	29.83 in	10.0 mi	SSW	11.5 mph	-	0.00 in	Rain	Light Rain
12:54 PM	63.0 °F	59.0 °F	87%	29.81 in	10.0 mi	South	11.5 mph	-	0.00 in		Overcast
1:54 PM	64.9 °F	61.0 °F	87%	29.79 in	10.0 mi	SSW	13.8 mph	-	0.01 in		Overcast
2:01 PM	66.2 °F	60.8 °F	83%	29.82 in	10.0 mi	SSW	13.8 mph	-	N/A		Overcast
2:54 PM	66.0 °F	55.9 °F	70%	29.78 in	10.0 mi	SW	13.8 mph	-	N/A		Mostly Cloudy
3:54 PM	70.0 °F	53.1 °F	55%	29.77 in	10.0 mi	WSW	19.6 mph	23.0 mph	N/A		Partly Cloudy
4:54 PM	69.1 °F	53.1 °F	57%	29.78 in	10.0 mi	West	17.3 mph	-	N/A		Scattered Clouds
5:54 PM	66.0 °F	51.1 °F	59%	29.78 in	10.0 mi	West	19.6 mph	-	N/A		Scattered Clouds
6:54 PM	63.0 °F	52.0 °F	67%	29.79 in	10.0 mi	WSW	13.8 mph	-	N/A		Partly Cloudy
7:54 PM	61.0 °F	53.1 °F	75%	29.82 in	10.0 mi	West	9.2 mph	-	N/A		Partly Cloudy
8:54 PM	59.0 °F	54.0 °F	83%	29.84 in	10.0 mi	West	11.5 mph	-	N/A		Clear
9:54 PM	57.9 °F	53.1 °F	84%	29.85 in	10.0 mi	WSW	5.8 mph	-	N/A		Clear

10/1/13

Weather History for Napa County, CA | Weather Underground

10:54 PM	55.9 °F	52.0 °F	87%	29.86 in	10.0 mi	Calm	Calm	-	N/A	Clear
11:54 PM	55.0 °F	52.0 °F	89%	29.87 in	10.0 mi	Calm	Calm	-	N/A	Clear

[Show full METARS](#) | [METAR FAQ](#) | [Comma Delimited File](#)

Weather History for Napa County, CA

Sunday, September 22, 2013

Sunday, September 22, 2013

« Previous Day

September 22 2013 View

Next Day »

- Daily
- Weekly
- Monthly
- Custom

	Actual	Average	Record
Temperature			
Mean Temperature	60 °F	64 °F	
Max Temperature	74 °F	79 °F	99 °F (2003)
Min Temperature	45 °F	48 °F	40 °F (2005)
Degree Days			
Heating Degree Days	5		
Month to date heating degree days	13		
Since 1 July heating degree days	49		
Cooling Degree Days	0		
Month to date cooling degree days	60		
Year to date cooling degree days	297		
Grow ing Degree Days	8 (Base 50)		
Moisture			
Dew Point	49 °F		
Average Humidity	72		
Maximum Humidity	100		
Minimum Humidity	44		
Precipitation			
Precipitation	0.00 in	-	0.40 in (1923)
Month to date precipitation	0.82		
Year to date precipitation	2.79		
Since 1 July precipitation	0.82		
Sea Level Pressure			
Sea Level Pressure	29.93 in		
Wind			
Wind Speed	4 mph (West)		
Max Wind Speed	20 mph		
Max Gust Speed	41 mph		
Visibility	7 miles		
Events	Fog		

T = Trace of Precipitation, MM = Missing Value

Source: NWS Daily Summary

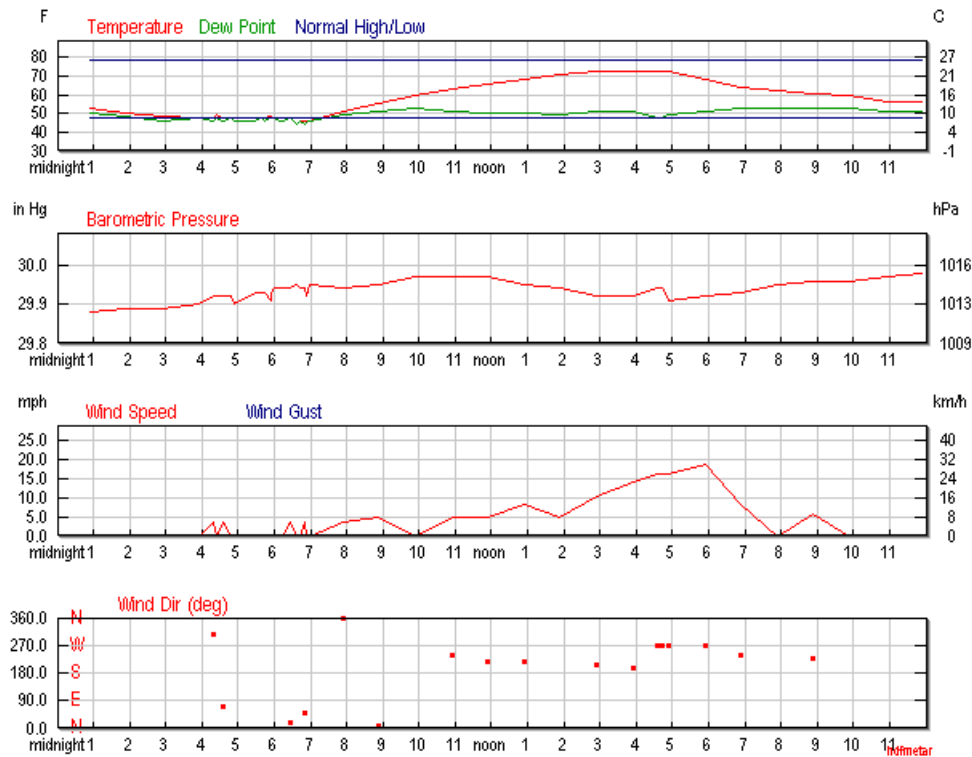

[Certify This Report](#)

Dream House Raffle
 Win this SILICON VALLEY DREAM HOUSE OR Choose \$4 million in cash
[LEARN MORE >>](#)

Hourly Weather History & Observations

Time (PDT)	Temp.	Windchill	Dew Point	Humidity	Pressure	Visibility	Wind Dir	Wind Speed	Gust Speed	Precip	Events	Conditions
12:54 AM	53.1 °F	-	51.1 °F	93%	29.88 in	10.0 mi	Calm	Calm	-	N/A		Clear
1:54 AM	51.1 °F	-	48.9 °F	92%	29.89 in	10.0 mi	Calm	Calm	-	N/A		Clear
2:54 AM	48.9 °F	-	46.9 °F	93%	29.89 in	10.0 mi	Calm	Calm	-	N/A		Clear
3:54 AM	48.0 °F	-	48.0 °F	100%	29.90 in	10.0 mi	Calm	Calm	-	N/A		Clear
4:18 AM	48.2 °F	-	46.4 °F	93%	29.92 in	1.8 mi	NW	3.5 mph	-	N/A		Clear
4:25 AM	50.0 °F	-	48.2 °F	94%	29.92 in	3.0 mi	Calm	Calm	-	N/A		Clear
4:36 AM	48.2 °F	-	46.4 °F	93%	29.92 in	2.5 mi	ENE	3.5 mph	-	N/A		Partly Cloudy
4:47 AM	48.2 °F	-	48.2 °F	100%	29.92 in	10.0 mi	Calm	Calm	-	N/A		Clear
4:54 AM	48.0 °F	-	46.9 °F	96%	29.90 in	9.0 mi	Calm	Calm	-	N/A		Clear
5:29 AM	48.2 °F	-	46.4 °F	93%	29.93 in	2.0 mi	Calm	Calm	-	N/A		Clear
5:39 AM	48.2 °F	-	48.2 °F	100%	29.93 in	9.0 mi	Calm	Calm	-	N/A		Clear
5:44 AM	48.2 °F	-	46.4 °F	93%	29.93 in	1.2 mi	Calm	Calm	-	N/A		Clear
5:54 AM	48.9 °F	-	48.0 °F	97%	29.91 in	1.8 mi	Calm	Calm	-	N/A		Clear
5:56 AM	48.2 °F	-	48.2 °F	100%	29.93 in	3.0 mi	Calm	Calm	-	N/A		Clear
5:59 AM	48.2 °F	-	48.2 °F	100%	29.94 in	1.8 mi	Calm	Calm	-	N/A		Clear
6:07 AM	48.2 °F	-	46.4 °F	93%	29.94 in	0.5 mi	Calm	Calm	-	N/A	Fog	Fog

6:14 AM	48.2 °F	-	46.4 °F	93%	29.94 in	1.0 mi	Calm	Calm	-	N/A	Clear
6:26 AM	48.2 °F	-	48.2 °F	100%	29.94 in	3.0 mi	NNE	3.5 mph	-	N/A	Clear
6:36 AM	44.6 °F	-	44.6 °F	100%	29.95 in	1.8 mi	Calm	Calm	-	N/A	Clear
6:43 AM	46.4 °F	-	46.4 °F	100%	29.94 in	3.0 mi	Calm	Calm	-	N/A	Clear
6:51 AM	46.4 °F	45.2 °F	44.6 °F	93%	29.94 in	1.8 mi	NE	3.5 mph	-	N/A	Clear
6:54 AM	46.9 °F	-	46.0 °F	97%	29.92 in	1.2 mi	Calm	Calm	-	N/A	Clear
6:59 AM	46.4 °F	-	46.4 °F	100%	29.95 in	10.0 mi	Calm	Calm	-	N/A	Clear
7:54 AM	52.0 °F	-	50.0 °F	93%	29.94 in	10.0 mi	North	3.5 mph	-	N/A	Clear
8:54 AM	55.9 °F	-	52.0 °F	87%	29.95 in	10.0 mi	North	4.6 mph	-	N/A	Clear
9:54 AM	60.1 °F	-	53.1 °F	78%	29.97 in	10.0 mi	Calm	Calm	-	N/A	Clear
10:54 AM	64.0 °F	-	52.0 °F	65%	29.97 in	10.0 mi	WSW	4.6 mph	-	N/A	Clear
11:54 AM	66.0 °F	-	51.1 °F	59%	29.97 in	10.0 mi	SW	4.6 mph	-	N/A	Partly Cloudy
12:54 PM	69.1 °F	-	51.1 °F	53%	29.95 in	10.0 mi	SW	8.1 mph	-	N/A	Scattered Clouds
1:54 PM	71.1 °F	-	50.0 °F	47%	29.94 in	10.0 mi	Variable	4.6 mph	-	N/A	Scattered Clouds
2:54 PM	73.0 °F	-	52.0 °F	48%	29.92 in	10.0 mi	SSW	10.4 mph	-	N/A	Scattered Clouds
3:54 PM	73.0 °F	-	52.0 °F	48%	29.92 in	10.0 mi	SSW	13.8 mph	-	N/A	Clear
4:35 PM	73.4 °F	-	48.2 °F	41%	29.94 in	10.0 mi	West	16.1 mph	-	N/A	Clear
4:44 PM	73.4 °F	-	48.2 °F	41%	29.94 in	10.0 mi	West	16.1 mph	-	N/A	Clear
4:54 PM	73.0 °F	-	50.0 °F	44%	29.91 in	10.0 mi	West	16.1 mph	-	N/A	Clear
5:54 PM	69.1 °F	-	52.0 °F	54%	29.92 in	10.0 mi	West	18.4 mph	-	N/A	Clear
6:54 PM	64.9 °F	-	53.1 °F	65%	29.93 in	10.0 mi	WSW	8.1 mph	-	N/A	Clear
7:54 PM	63.0 °F	-	53.1 °F	70%	29.95 in	10.0 mi	Calm	Calm	-	N/A	Clear
8:54 PM	61.0 °F	-	53.1 °F	75%	29.96 in	10.0 mi	SW	5.8 mph	-	N/A	Clear
9:54 PM	60.1 °F	-	53.1 °F	78%	29.96 in	10.0 mi	Calm	Calm	-	N/A	Clear
10:54 PM	57.0 °F	-	52.0 °F	83%	29.97 in	10.0 mi	Calm	Calm	-	N/A	Clear
11:54 PM	57.0 °F	-	52.0 °F	83%	29.98 in	10.0 mi	Calm	Calm	-	N/A	Clear

[Show full METARS](#) | [METAR FAQ](#) | [Comma Delimited File](#)

Weather History for Napa County, CA

Monday, September 23, 2013

Monday, September 23, 2013

[« Previous Day](#)

September 23 2013 [View](#)

[Next Day »](#)

- Daily
- Weekly
- Monthly
- Custom

	Actual	Average	Record
Temperature			
Mean Temperature	66 °F	63 °F	
Max Temperature	81 °F	79 °F	94 °F (2002)
Min Temperature	50 °F	48 °F	39 °F (1932)
Degree Days			
Heating Degree Days	0		
Month to date heating degree days	13		
Since 1 July heating degree days	49		
Cooling Degree Days	1		
Month to date cooling degree days	61		
Year to date cooling degree days	298		
Growing Degree Days	15 (Base 50)		
Moisture			
Dew Point	54 °F		
Average Humidity	68		
Maximum Humidity	96		
Minimum Humidity	39		
Precipitation			
Precipitation	0.00 in	-	0.36 in (1990)
Month to date precipitation	0.82		
Year to date precipitation	2.79		
Since 1 July precipitation	0.82		
Sea Level Pressure			
Sea Level Pressure	29.95 in		
Wind			
Wind Speed	5 mph (SW)		
Max Wind Speed	18 mph		
Max Gust Speed	21 mph		
Visibility	10 miles		
Events			

T = Trace of Precipitation, MM = Missing Value

Source: NWS Daily Summary

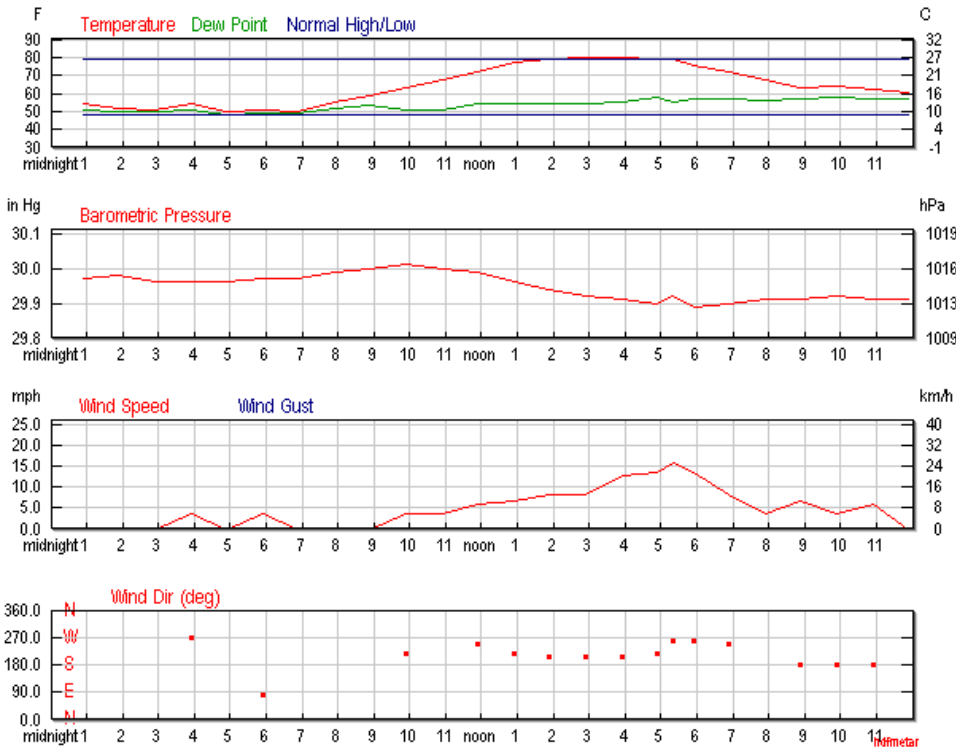

Certify This Report

24/7 ACCESS TO CARS AROUND THE globe.
 GAS & INSURANCE INCLUDED.
 join now for \$50 FREE driving.
 zipcar.
 let's go

Hourly Weather History & Observations

Time (PDT)	Temp.	Heat Index	Dew Point	Humidity	Pressure	Visibility	Wind Dir	Wind Speed	Gust Speed	Precip	Events	Conditions
12:54 AM	54.0 °F	-	51.1 °F	90%	29.97 in	10.0 mi	Calm	Calm	-	N/A		Clear
1:54 AM	52.0 °F	-	50.0 °F	93%	29.98 in	10.0 mi	Calm	Calm	-	N/A		Clear
2:54 AM	51.1 °F	-	50.0 °F	96%	29.96 in	10.0 mi	Calm	Calm	-	N/A		Clear
3:54 AM	54.0 °F	-	51.1 °F	90%	29.96 in	10.0 mi	West	3.5 mph	-	N/A		Clear
4:54 AM	50.0 °F	-	48.0 °F	93%	29.96 in	10.0 mi	Calm	Calm	-	N/A		Clear
5:54 AM	51.1 °F	-	48.9 °F	92%	29.97 in	10.0 mi	East	3.5 mph	-	N/A		Clear
6:54 AM	50.0 °F	-	48.9 °F	96%	29.97 in	10.0 mi	Calm	Calm	-	N/A		Clear
7:54 AM	55.0 °F	-	52.0 °F	89%	29.99 in	10.0 mi	Calm	Calm	-	N/A		Clear
8:54 AM	59.0 °F	-	53.1 °F	81%	30.00 in	10.0 mi	Calm	Calm	-	N/A		Clear
9:54 AM	63.0 °F	-	51.1 °F	65%	30.01 in	10.0 mi	SW	3.5 mph	-	N/A		Clear
10:54 AM	68.0 °F	-	51.1 °F	55%	30.00 in	10.0 mi	Variable	3.5 mph	-	N/A		Clear
11:54 AM	72.0 °F	-	54.0 °F	53%	29.99 in	10.0 mi	WSW	5.8 mph	-	N/A		Clear
12:54 PM	77.0 °F	-	54.0 °F	45%	29.96 in	10.0 mi	SW	6.9 mph	-	N/A		Clear
1:54 PM	79.0 °F	-	54.0 °F	42%	29.94 in	10.0 mi	SSW	8.1 mph	-	N/A		Clear
2:54 PM	80.1 °F	80.0 °F	54.0 °F	40%	29.92 in	10.0 mi	SSW	8.1 mph	-	N/A		Clear
3:54 PM	80.1 °F	80.1 °F	55.0 °F	42%	29.91 in	10.0 mi	SSW	12.7 mph	-	N/A		Clear
4:54 PM	79.0 °F	-	57.9 °F	48%	29.90 in	10.0 mi	SW	13.8 mph	-	N/A		Clear

5:21 PM	78.8 °F	-	55.4 °F	44%	29.92 in	10.0 mi	West	16.1 mph	-	N/A	Clear
5:54 PM	75.9 °F	-	57.0 °F	52%	29.89 in	10.0 mi	West	13.8 mph	-	N/A	Clear
6:54 PM	72.0 °F	-	57.0 °F	59%	29.90 in	10.0 mi	WSW	8.1 mph	-	N/A	Clear
7:54 PM	68.0 °F	-	55.9 °F	65%	29.91 in	10.0 mi	Variable	3.5 mph	-	N/A	Clear
8:54 PM	63.0 °F	-	57.0 °F	81%	29.91 in	10.0 mi	South	6.9 mph	-	N/A	Clear
9:54 PM	64.0 °F	-	57.9 °F	80%	29.92 in	10.0 mi	South	3.5 mph	-	N/A	Clear
10:54 PM	62.1 °F	-	57.0 °F	84%	29.91 in	10.0 mi	South	5.8 mph	-	N/A	Clear
11:54 PM	60.1 °F	-	57.0 °F	90%	29.91 in	10.0 mi	Calm	Calm	-	N/A	Clear

[Show full METARS](#) | [METAR FAQ](#) | [Comma Delimited File](#)

Weather History for Napa County, CA

Tuesday, September 24, 2013

Tuesday, September 24, 2013

« Previous Day

September 24 2013 View

Next Day »

Daily

Weekly

Monthly

Custom

	Actual	Average	Record
Temperature			
Mean Temperature	66 °F	63 °F	
Max Temperature	80 °F	79 °F	91 °F (2004)
Min Temperature	52 °F	48 °F	40 °F (2005)
Degree Days			
Heating Degree Days	0		
Month to date heating degree days	13		
Since 1 July heating degree days	49		
Cooling Degree Days	1		
Month to date cooling degree days	62		
Year to date cooling degree days	299		
Growing Degree Days	17 (Base 50)		
Moisture			
Dew Point	51 °F		
Average Humidity	64		
Maximum Humidity	93		
Minimum Humidity	35		
Precipitation			
Precipitation	0.00 in	-	0.62 in (1986)
Month to date precipitation	0.82		
Year to date precipitation	2.79		
Since 1 July precipitation	0.82		
Sea Level Pressure			
Sea Level Pressure	29.89 in		
Wind			
Wind Speed	14 mph (West)		
Max Wind Speed	29 mph		
Max Gust Speed	36 mph		
Visibility	10 miles		
Events			

T = Trace of Precipitation, MM = Missing Value

Source: NWS Daily Summary

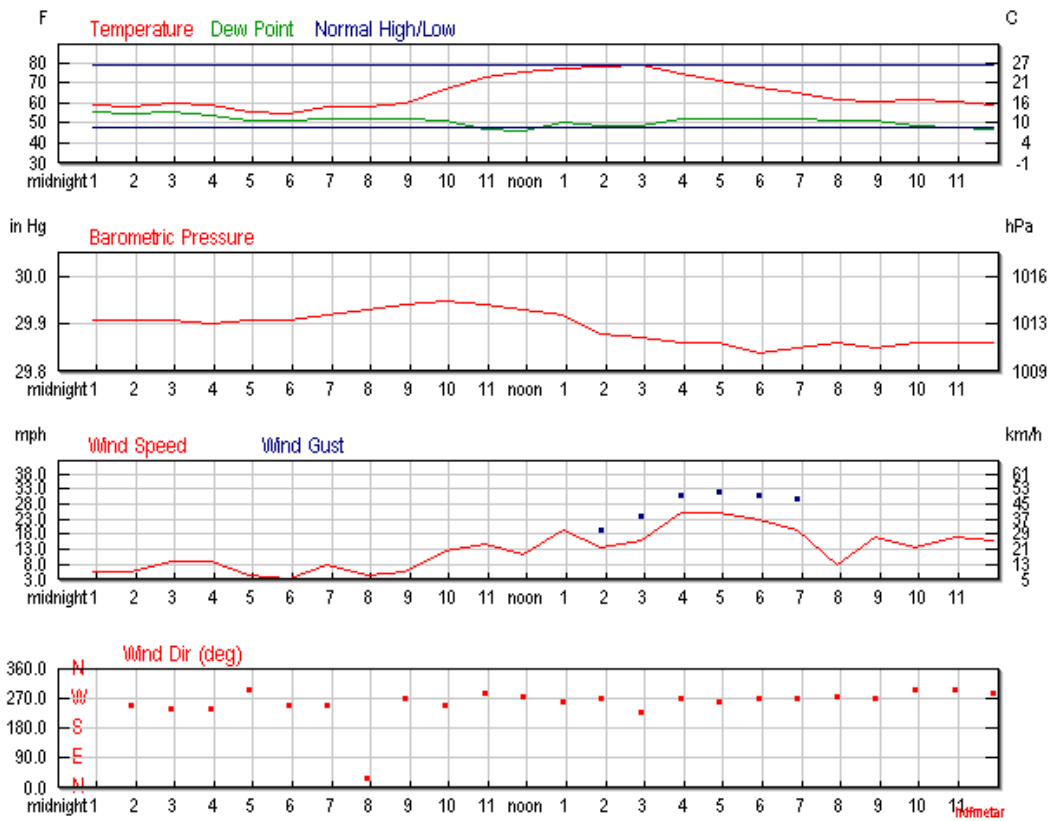

[Certify This Report](#)



Hourly Weather History & Observations

Time (PDT)	Temp.	Dew Point	Humidity	Pressure	Visibility	Wind Dir	Wind Speed	Gust Speed	Precip	Events	Conditions
12:54 AM	59.0 °F	55.9 °F	90%	29.91 in	10.0 mi	SSW	5.8 mph	-	N/A		Clear
1:54 AM	57.9 °F	55.0 °F	90%	29.91 in	10.0 mi	WSW	5.8 mph	-	N/A		Clear
2:54 AM	60.1 °F	55.9 °F	86%	29.91 in	10.0 mi	WSW	9.2 mph	-	N/A		Clear
3:54 AM	59.0 °F	54.0 °F	83%	29.90 in	10.0 mi	WSW	9.2 mph	-	N/A		Clear
4:54 AM	55.9 °F	51.1 °F	84%	29.91 in	10.0 mi	WNW	4.6 mph	-	N/A		Clear
5:54 AM	55.0 °F	51.1 °F	86%	29.91 in	10.0 mi	WSW	3.5 mph	-	N/A		Clear
6:54 AM	57.9 °F	52.0 °F	81%	29.92 in	10.0 mi	WSW	8.1 mph	-	N/A		Clear
7:54 AM	57.9 °F	52.0 °F	81%	29.93 in	10.0 mi	NNE	4.6 mph	-	N/A		Mostly Cloudy
8:54 AM	60.1 °F	52.0 °F	75%	29.94 in	10.0 mi	West	5.8 mph	-	N/A		Clear
9:54 AM	66.9 °F	51.1 °F	57%	29.95 in	10.0 mi	WSW	12.7 mph	-	N/A		Clear
10:54 AM	73.0 °F	46.9 °F	39%	29.94 in	10.0 mi	WNW	15.0 mph	-	N/A		Clear
11:54 AM	75.9 °F	46.0 °F	35%	29.93 in	10.0 mi	West	11.5 mph	-	N/A		Clear
12:54 PM	77.0 °F	50.0 °F	39%	29.92 in	10.0 mi	West	19.6 mph	26.5 mph	N/A		Clear

1:54 PM	78.1 °F	48.9 °F	36%	29.88 in	10.0 mi	West	13.8 mph	19.6 mph	N/A	Clear
2:54 PM	79.0 °F	48.9 °F	35%	29.87 in	10.0 mi	SW	16.1 mph	24.2 mph	N/A	Clear
3:54 PM	75.0 °F	52.0 °F	44%	29.86 in	10.0 mi	West	25.3 mph	31.1 mph	N/A	Clear
4:54 PM	71.1 °F	52.0 °F	51%	29.86 in	10.0 mi	West	25.3 mph	32.2 mph	N/A	Clear
5:54 PM	68.0 °F	52.0 °F	56%	29.84 in	10.0 mi	West	23.0 mph	31.1 mph	N/A	Clear
6:54 PM	64.9 °F	52.0 °F	63%	29.85 in	10.0 mi	West	19.6 mph	29.9 mph	N/A	Clear
7:54 PM	62.1 °F	51.1 °F	67%	29.86 in	10.0 mi	West	8.1 mph	-	N/A	Clear
8:54 PM	61.0 °F	51.1 °F	70%	29.85 in	10.0 mi	West	17.3 mph	23.0 mph	N/A	Clear
9:54 PM	62.1 °F	48.9 °F	62%	29.86 in	10.0 mi	WNW	13.8 mph	-	N/A	Clear
10:54 PM	61.0 °F	48.0 °F	62%	29.86 in	10.0 mi	WNW	17.3 mph	-	N/A	Clear
11:54 PM	59.0 °F	46.9 °F	64%	29.86 in	10.0 mi	WNW	16.1 mph	20.7 mph	N/A	Clear

[Show full METARS](#) | [METAR FAQ](#) | [Comma Delimited File](#)

Weather History for Napa County, CA

Wednesday, September 25, 2013

Wednesday, September 25, 2013

« Previous Day

September ▾

25 ▾

2013 ▾

View

Next Day »

Daily

Weekly

Monthly

Custom

	Actual	Average	Record
Temperature			
Mean Temperature	62 °F	63 °F	
Max Temperature	74 °F	79 °F	95 °F (2010)
Min Temperature	49 °F	47 °F	37 °F (2005)
Degree Days			
Heating Degree Days	3		
Month to date heating degree days	16		
Since 1 July heating degree days	52		
Cooling Degree Days	0		
Month to date cooling degree days	62		
Year to date cooling degree days	299		
Growing Degree Days	12 (Base 50)		
Moisture			
Dew Point	45 °F		
Average Humidity	57		
Maximum Humidity	83		
Minimum Humidity	31		
Precipitation			
Precipitation	0.00 in	-	0.26 in (1986)
Month to date precipitation	0.82		
Year to date precipitation	2.79		
Since 1 July precipitation	0.82		
Sea Level Pressure			
Sea Level Pressure	29.85 in		
Wind			
Wind Speed	8 mph (WNW)		
Max Wind Speed	30 mph		
Max Gust Speed	37 mph		
Visibility	10 miles		
Events			

T = Trace of Precipitation, MM = Missing Value

Source: NWS Daily Summary

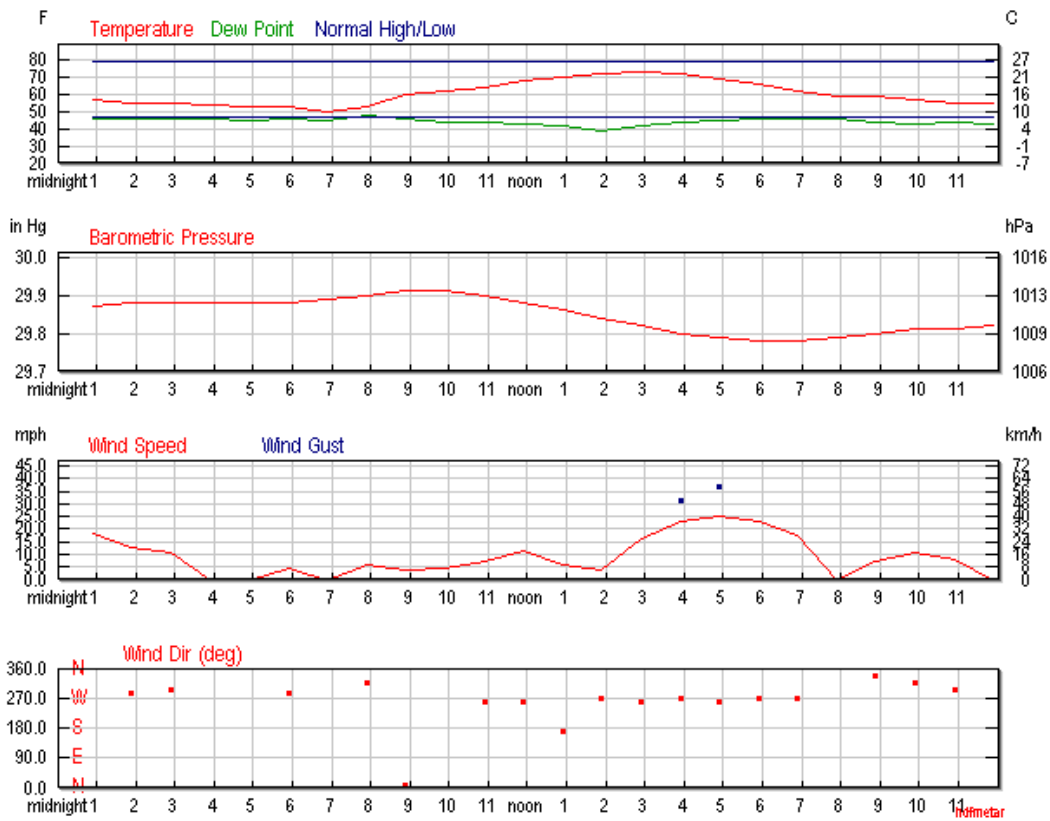

[Certify This Report](#)



Hourly Weather History & Observations

Time (PDT)	Temp.	Dew Point	Humidity	Pressure	Visibility	Wind Dir	Wind Speed	Gust Speed	Precip	Events	Conditions
12:54 AM	57.0 °F	46.9 °F	69%	29.87 in	10.0 mi	WNW	18.4 mph	-	N/A		Clear
1:54 AM	55.0 °F	46.9 °F	74%	29.88 in	10.0 mi	WNW	12.7 mph	-	N/A		Clear
2:54 AM	55.9 °F	46.9 °F	72%	29.88 in	10.0 mi	WNW	10.4 mph	-	N/A		Clear
3:54 AM	54.0 °F	46.0 °F	75%	29.88 in	10.0 mi	Calm	Calm	-	N/A		Clear
4:54 AM	53.1 °F	45.0 °F	74%	29.88 in	10.0 mi	Calm	Calm	-	N/A		Clear
5:54 AM	53.1 °F	46.0 °F	77%	29.88 in	10.0 mi	WNW	4.6 mph	-	N/A		Clear
6:54 AM	50.0 °F	45.0 °F	83%	29.89 in	10.0 mi	Calm	Calm	-	N/A		Clear
7:54 AM	53.1 °F	48.9 °F	86%	29.90 in	10.0 mi	NW	5.8 mph	-	N/A		Clear
8:54 AM	60.1 °F	46.9 °F	62%	29.91 in	10.0 mi	North	3.5 mph	-	N/A		Clear
9:54 AM	62.1 °F	44.1 °F	52%	29.91 in	10.0 mi	Variable	4.6 mph	-	N/A		Clear
10:54 AM	64.9 °F	44.1 °F	47%	29.90 in	10.0 mi	West	6.9 mph	-	N/A		Clear
11:54 AM	68.0 °F	43.0 °F	40%	29.88 in	10.0 mi	West	11.5 mph	-	N/A		Clear
12:54 PM	70.0 °F	42.1 °F	36%	29.86 in	10.0 mi	South	5.8 mph	-	N/A		Clear

10/1/13

Weather History for Napa County, CA | Weather Underground

1:54 PM	72.0 °F	39.9 °F	31%	29.84 in	10.0 mi	West	3.5 mph	-	N/A	Clear
2:54 PM	73.0 °F	42.1 °F	33%	29.82 in	10.0 mi	West	16.1 mph	23.0 mph	N/A	Partly Cloudy
3:54 PM	72.0 °F	44.1 °F	37%	29.80 in	10.0 mi	West	23.0 mph	31.1 mph	N/A	Clear
4:54 PM	69.1 °F	45.0 °F	42%	29.79 in	10.0 mi	West	25.3 mph	36.8 mph	N/A	Clear
5:54 PM	66.0 °F	46.0 °F	48%	29.78 in	10.0 mi	West	23.0 mph	-	N/A	Clear
6:54 PM	62.1 °F	46.9 °F	58%	29.78 in	10.0 mi	West	17.3 mph	-	N/A	Clear
7:54 PM	59.0 °F	46.0 °F	62%	29.79 in	10.0 mi	Calm	Calm	-	N/A	Clear
8:54 PM	59.0 °F	44.1 °F	58%	29.80 in	10.0 mi	NNW	6.9 mph	-	N/A	Clear
9:54 PM	57.0 °F	43.0 °F	59%	29.81 in	10.0 mi	NW	10.4 mph	-	N/A	Clear
10:54 PM	55.0 °F	44.1 °F	67%	29.81 in	10.0 mi	WNW	8.1 mph	-	N/A	Clear
11:54 PM	55.0 °F	43.0 °F	64%	29.82 in	10.0 mi	Calm	Calm	-	N/A	Clear

[Show full METARS](#) | [METAR FAQ](#) | [Comma Delimited File](#)

APPENDIX D
Construction Noise Calculation Sheets

Demolition Noise Model
Roadway Construction Noise Model (RCNM), Version 1.1

Report date: 02/18/2014
Case Description: General Mills Demolition

**** Receptor #1 ****

Description	Land Use	Baselines (dBA)		
		Daytime	Evening	Night
NSL1	Residential	54.0	50.0	48.0

Estimated Shielding Description (dBA)	Equipment		Spec	Actual	Receptor
	Impact Device	Usage (%)	Lmax (dBA)	Lmax (dBA)	Distance (feet)
Front End Loader 0.0	No	40		79.1	1148.3
Excavator 0.0	No	40		80.7	1148.3
Excavator 0.0	No	40		80.7	1148.3
Crane 0.0	No	16		80.6	1148.3
Mounted Impact Hammer (hoe ram) 0.0	Yes	20		90.3	1148.3
Grapple (on backhoe) 0.0	No	40		87.0	1148.3
Dump Truck 0.0	No	40		76.5	1148.3
All Other Equipment > 5 HP 0.0	No	50	85.0		1148.3

Results

Limits (dBA)				Noise Limit Exceedance (dBA)				Noise	
Night		Day		Calculated (dBA) Evening		Day Night		Evening	
L10	Lmax	L10	Lmax	L10	L10	Lmax	L10	L10	Lmax
Front End Loader				51.9	50.9	N/A	N/A	N/A	N/A
N/A	N/A	N/A	N/A	N/A	N/A	N/A	N/A	N/A	N/A
Excavator				53.5	52.5	N/A	N/A	N/A	N/A
N/A	N/A	N/A	N/A	N/A	N/A	N/A	N/A	N/A	N/A
Excavator				53.5	52.5	N/A	N/A	N/A	N/A
N/A	N/A	N/A	N/A	N/A	N/A	N/A	N/A	N/A	N/A
Crane				53.3	48.4	N/A	N/A	N/A	N/A
N/A	N/A	N/A	N/A	N/A	N/A	N/A	N/A	N/A	N/A
Mounted Impact Hammer (hoe ram)				63.1	59.1	N/A	N/A	N/A	N/A
N/A	N/A	N/A	N/A	N/A	N/A	N/A	N/A	N/A	N/A
Grapple (on backhoe)				59.8	58.8	N/A	N/A	N/A	N/A
N/A	N/A	N/A	N/A	N/A	N/A	N/A	N/A	N/A	N/A
Dump Truck				49.2	48.2	N/A	N/A	N/A	N/A

Demolition Noise Model

N/A	N/A	N/A	N/A	N/A	N/A	N/A	N/A	N/A	N/A	N/A
All Other Equipment	> 5 HP			57.8	57.8					
			Total	63.1	64.4					
N/A	N/A	N/A	N/A	N/A	N/A	N/A	N/A	N/A	N/A	N/A

**** Receptor #2 ****

Description	Land Use	Baselines (dBA)		
		Daytime	Evening	Night
NSL2	Residential	52.0	48.0	45.0

Equipment

Estimated Shielding Description (dBA)	Impact Device	Usage (%)	Spec	Actual	Receptor
			Lmax (dBA)	Lmax (dBA)	Distance (feet)
Front End Loader	No	40		79.1	400.3
Excavator	No	40		80.7	400.3
Excavator	No	40		80.7	400.3
Crane	No	16		80.6	400.3
Mounted Impact Hammer (hoe ram)	Yes	20		90.3	400.3
Grapple (on backhoe)	No	40		87.0	400.3
Dump Truck	No	40		76.5	400.3
All Other Equipment > 5 HP	No	50	85.0		3280.8

Results

Limits (dBA)	Noise Limit Exceedance (dBA)				Noise				
	Night		Day		Evening		Night		
Equipment	L10	Lmax	L10	Lmax	Calculated (dBA)	L10	Lmax	L10	Lmax
Front End Loader	N/A	N/A	N/A	N/A	61.0	60.1	N/A	N/A	N/A
Excavator	N/A	N/A	N/A	N/A	62.6	61.7	N/A	N/A	N/A
Excavator	N/A	N/A	N/A	N/A	62.6	61.7	N/A	N/A	N/A
Crane	N/A	N/A	N/A	N/A	62.5	57.5	N/A	N/A	N/A
Mounted Impact Hammer (hoe ram)	N/A	N/A	N/A	N/A	72.2	68.2	N/A	N/A	N/A
Grapple (on backhoe)	N/A	N/A	N/A	N/A	68.9	68.0	N/A	N/A	N/A

Demolition Noise Model

Dump Truck				58.4	57.4	N/A	N/A	N/A	N/A
N/A	N/A	N/A	N/A	N/A	N/A	N/A	N/A	N/A	N/A
All Other Equipment > 5 HP				48.7	48.6	N/A	N/A	N/A	N/A
N/A	N/A	N/A	N/A	N/A	N/A	N/A	N/A	N/A	N/A
			Total	72.2	72.6		N/A	N/A	N/A
N/A	N/A	N/A	N/A	N/A	N/A	N/A	N/A	N/A	N/A

**** Receptor #3 ****

Description	Land Use	Baselines (dBA)		
		Daytime	Evening	Night
NSL3	Residential	49.0	45.0	45.0

Equipment

Estimated Shielding Description (dBA)	Impact Device	Usage (%)	Spec	Actual	Receptor
			Lmax (dBA)	Lmax (dBA)	Distance (feet)
Front End Loader 0.0	No	40		79.1	607.0
Excavator 0.0	No	40		80.7	607.0
Excavator 0.0	No	40		80.7	607.0
Crane 0.0	No	16		80.6	607.0
Mounted Impact Hammer (hoe ram) 0.0	Yes	20		90.3	607.0
Grapple (on backhoe) 0.0	No	40		87.0	607.0
Dump Truck 0.0	No	40		76.5	607.0
All Other Equipment > 5 HP 0.0	No	50	85.0		607.0

Results

Limits (dBA)				Noise Limit Exceedance (dBA)				Noise	
-----				-----					
Night		Day		Calculated (dBA) Evening		Day Night		Evening	
-----		-----		-----		-----		-----	
Equipment	L10	Lmax	L10	Lmax	L10	Lmax	L10	Lmax	L10

Front End Loader				57.4	56.4	N/A	N/A	N/A	N/A
N/A	N/A	N/A	N/A	N/A	N/A	N/A	N/A	N/A	N/A
Excavator				59.0	58.0	N/A	N/A	N/A	N/A
N/A	N/A	N/A	N/A	N/A	N/A	N/A	N/A	N/A	N/A
Excavator				59.0	58.0	N/A	N/A	N/A	N/A
N/A	N/A	N/A	N/A	N/A	N/A	N/A	N/A	N/A	N/A
Crane				58.9	53.9	N/A	N/A	N/A	N/A
N/A	N/A	N/A	N/A	N/A	N/A	N/A	N/A	N/A	N/A
Mounted Impact Hammer (hoe ram)				68.6	64.6	N/A	N/A	N/A	N/A
N/A	N/A	N/A	N/A	N/A	N/A	N/A	N/A	N/A	N/A
Grapple (on backhoe)				65.3	64.3	N/A	N/A	N/A	N/A

Demolition Noise Model

N/A	N/A	N/A	N/A	N/A	N/A	N/A	N/A	N/A	N/A	N/A
Dump Truck				54.8	53.8		N/A	N/A	N/A	N/A
All Other Equipment > 5 HP				63.3	63.3		N/A	N/A	N/A	N/A
				N/A	N/A		N/A	N/A	N/A	N/A
			Total	68.6	70.0		N/A	N/A	N/A	N/A
N/A	N/A	N/A	N/A	N/A	N/A	N/A	N/A	N/A	N/A	N/A

Ground works noise model
Roadway Construction Noise Model (RCNM), version 1.1

Report date: 02/18/2014
Case Description: General Mills Demolition

**** Receptor #1 ****

Description	Land Use	Baselines (dBA)		
		Daytime	Evening	Night
NSL1	Residential	54.0	50.0	48.0

Estimated Shielding Description (dBA)	Equipment		Spec	Actual	Receptor
	Impact Device	Usage (%)	Lmax (dBA)	Lmax (dBA)	Distance (feet)
Backhoe 0.0	No	40		77.6	1148.3
Excavator 0.0	No	40		80.7	1148.3
Excavator 0.0	No	40		80.7	1148.3
Front End Loader 0.0	No	40		79.1	1148.3
Roller 0.0	No	20		80.0	1148.3
Tractor 0.0	No	40	84.0		1148.3
Vacuum Street Sweeper 0.0	No	10		81.6	1148.3
All Other Equipment > 5 HP 0.0	No	50	85.0		1148.3

Results

(dBA)	Noise Limit Exceedance (dBA)						Noise Limits			
	Night		Day		Calculated (dBA) Evening		Day Night		Evening	
Equipment Lmax L10	Lmax	L10	Lmax	L10	Lmax	L10	Lmax	L10	Lmax	L10
Backhoe N/A N/A	N/A	N/A	50.3	49.4	N/A	N/A	N/A	N/A	N/A	N/A
Excavator N/A N/A	N/A	N/A	53.5	52.5	N/A	N/A	N/A	N/A	N/A	N/A
Excavator N/A N/A	N/A	N/A	53.5	52.5	N/A	N/A	N/A	N/A	N/A	N/A
Front End Loader N/A N/A	N/A	N/A	51.9	50.9	N/A	N/A	N/A	N/A	N/A	N/A
Roller N/A N/A	N/A	N/A	52.8	48.8	N/A	N/A	N/A	N/A	N/A	N/A
Tractor N/A N/A	N/A	N/A	56.8	55.8	N/A	N/A	N/A	N/A	N/A	N/A
Vacuum Street Sweeper			54.4	47.4	N/A	N/A	N/A	N/A	N/A	N/A

Ground works noise model										
N/A	N/A	N/A	N/A	N/A	N/A	N/A	N/A	N/A	N/A	N/A
All Other Equipment	> 5 HP	57.8	57.8	N/A	N/A	N/A	N/A	N/A	N/A	N/A
N/A	N/A	N/A	N/A	N/A	N/A	N/A	N/A	N/A	N/A	N/A
	Total	57.8	62.2	N/A	N/A	N/A	N/A	N/A	N/A	N/A
N/A	N/A	N/A	N/A	N/A	N/A	N/A	N/A	N/A	N/A	N/A

**** Receptor #2 ****

Description	Land Use	Baselines (dBA)		
		Daytime	Evening	Night
NSL2	Residential	52.0	48.0	45.0

Estimated Shielding Description (dBA)	Equipment		Spec Lmax (dBA)	Actual Lmax (dBA)	Receptor Distance (feet)
	Impact Device	Usage (%)			
Backhoe 0.0	No	40		77.6	400.3
Excavator 0.0	No	40		80.7	400.3
Excavator 0.0	No	40		80.7	400.3
Front End Loader 0.0	No	40		79.1	400.3
Roller 0.0	No	20		80.0	400.3
Tractor 0.0	No	40	84.0		400.3
Vacuum Street Sweeper 0.0	No	10		81.6	400.3
All Other Equipment > 5 HP 0.0	No	50	85.0		3280.8

Results

(dBA)	Noise Limit Exceedance (dBA)						Noise Limits	
	Night	Day	Calculated (dBA) Evening		Day Night		Evening	
Equipment Lmax L10	Lmax	L10	Lmax	L10	Lmax	L10	Lmax	L10
Backhoe N/A N/A	N/A	N/A	59.5	58.5	N/A	N/A	N/A	N/A
Excavator N/A N/A	N/A	N/A	62.6	61.7	N/A	N/A	N/A	N/A
Excavator N/A N/A	N/A	N/A	62.6	61.7	N/A	N/A	N/A	N/A
Front End Loader N/A N/A	N/A	N/A	61.0	60.1	N/A	N/A	N/A	N/A
Roller N/A N/A	N/A	N/A	61.9	57.9	N/A	N/A	N/A	N/A
Tractor N/A N/A	N/A	N/A	65.9	65.0	N/A	N/A	N/A	N/A

			Ground works noise model							
Vacuum Street Sweeper			63.5	56.5	N/A	N/A	N/A	N/A	N/A	N/A
N/A	N/A	N/A	N/A	N/A	N/A	N/A	N/A	N/A	N/A	N/A
All Other Equipment > 5 HP			48.7	48.6	N/A	N/A	N/A	N/A	N/A	N/A
N/A	N/A	N/A	N/A	N/A	N/A	N/A	N/A	N/A	N/A	N/A
		Total	65.9	69.5	N/A	N/A	N/A	N/A	N/A	N/A
N/A	N/A	N/A	N/A	N/A	N/A	N/A	N/A	N/A	N/A	N/A

**** Receptor #3 ****

Description	Land Use	Daytime	Baselines (dBA)		Receptor	
			Evening	Night		
NSL3	Residential	49.0	45.0	45.0		
Equipment						
Estimated		Impact	Usage	Spec	Actual	Receptor
Shielding		Device	(%)	Lmax	Lmax	Distance
Description				(dBA)	(dBA)	(feet)
(dBA)						
Backhoe		No	40		77.6	607.0
0.0						
Excavator		No	40		80.7	607.0
0.0						
Excavator		No	40		80.7	607.0
0.0						
Front End Loader		No	40		79.1	607.0
0.0						
Roller		No	20		80.0	607.0
0.0						
Tractor		No	40	84.0		607.0
0.0						
Vacuum Street Sweeper		No	10		81.6	607.0
0.0						
All Other Equipment > 5 HP		No	50	85.0		607.0
0.0						

Results

(dBA)		Noise Limit Exceedance (dBA)						Noise Limits	
		Calculated (dBA)			Day		Evening		
		Evening			Night				
Equipment		Lmax		L10		Lmax		L10	
Lmax	L10	Lmax	L10	Lmax	L10	Lmax	L10	Lmax	L10
Backhoe		55.9	54.9	N/A	N/A	N/A	N/A	N/A	N/A
N/A	N/A	N/A	N/A	N/A	N/A	N/A	N/A	N/A	N/A
Excavator		59.0	58.0	N/A	N/A	N/A	N/A	N/A	N/A
N/A	N/A	N/A	N/A	N/A	N/A	N/A	N/A	N/A	N/A
Excavator		59.0	58.0	N/A	N/A	N/A	N/A	N/A	N/A
N/A	N/A	N/A	N/A	N/A	N/A	N/A	N/A	N/A	N/A
Front End Loader		57.4	56.4	N/A	N/A	N/A	N/A	N/A	N/A
N/A	N/A	N/A	N/A	N/A	N/A	N/A	N/A	N/A	N/A
Roller		58.3	54.3	N/A	N/A	N/A	N/A	N/A	N/A
N/A	N/A	N/A	N/A	N/A	N/A	N/A	N/A	N/A	N/A
Tractor		62.3	61.3	N/A	N/A	N/A	N/A	N/A	N/A

			Ground works noise model						
N/A	N/A	N/A	N/A	N/A	N/A	N/A	N/A	N/A	N/A
Vacuum Street Sweeper			59.9	52.9		N/A	N/A	N/A	N/A
N/A	N/A	N/A	N/A	N/A	N/A	N/A	N/A	N/A	N/A
All Other Equipment > 5 HP			63.3	63.3		N/A	N/A	N/A	N/A
N/A	N/A	N/A	N/A	N/A	N/A	N/A	N/A	N/A	N/A
		Total	63.3	67.8		N/A	N/A	N/A	N/A
N/A	N/A	N/A	N/A	N/A	N/A	N/A	N/A	N/A	N/A

Concrete & Steel Noise Model
Roadway Construction Noise Model (RCNM), Version 1.1

Report date: 02/18/2014
Case Description: General Mills Demolition

**** Receptor #1 ****

Description	Land Use	Daytime	Baselines (dBA)	
			Evening	Night
NSL1	Residential	54.0	50.0	48.0

Equipment

Description	Impact Device	Usage (%)	Spec Lmax (dBA)	Actual Lmax (dBA)	Receptor Distance (feet)	Estimated Shielding (dBA)
Concrete Mixer Truck	No	40		78.8	1066.3	0.0
Concrete Pump Truck	No	20		81.4	1066.3	0.0
Concrete Saw	No	20		89.6	1066.3	0.0
Crane	No	16		80.6	1066.3	0.0
Drum Mixer	No	50		80.0	1066.3	0.0
Flat Bed Truck	No	40		74.3	1066.3	0.0
Pneumatic Tools	No	50		85.2	1066.3	0.0
Welder / Torch	No	40		74.0	1066.3	0.0

Results

Noise Limit Exceedance (dBA) Noise Limits (dBA)

Equipment	Night		Calculated (dBA)			Day		Evening	
	Lmax	L10	Lmax	L10	Lmax	L10	Lmax	L10	
Concrete Mixer Truck	N/A	N/A	52.2	51.2	N/A	N/A	N/A	N/A	
Concrete Pump Truck	N/A	N/A	54.8	50.8	N/A	N/A	N/A	N/A	
Concrete Saw	N/A	N/A	63.0	59.0	N/A	N/A	N/A	N/A	
Crane	N/A	N/A	54.0	49.0	N/A	N/A	N/A	N/A	
Drum Mixer	N/A	N/A	53.4	53.4	N/A	N/A	N/A	N/A	
Flat Bed Truck	N/A	N/A	47.7	46.7	N/A	N/A	N/A	N/A	
Pneumatic Tools	N/A	N/A	58.6	58.6	N/A	N/A	N/A	N/A	
Welder / Torch	N/A	N/A	47.4	46.4	N/A	N/A	N/A	N/A	
Total	N/A	N/A	63.0	63.4	N/A	N/A	N/A	N/A	

**** Receptor #2 ****

Description	Land Use	Daytime	Baselines (dBA)	
			Evening	Night
NSL2	Residential	52.0	48.0	45.0

Concrete & Steel Noise Model

Equipment

Description	Impact Device	Usage (%)	Spec Lmax (dBA)	Actual Lmax (dBA)	Receptor Distance (feet)	Estimated Shielding (dBA)
Concrete Mixer Truck	No	40		78.8	370.7	0.0
Concrete Pump Truck	No	20		81.4	370.7	0.0
Concrete Saw	No	20		89.6	370.7	0.0
Crane	No	16		80.6	370.7	0.0
Drum Mixer	No	50		80.0	370.7	0.0
Flat Bed Truck	No	40		74.3	370.7	0.0
Pneumatic Tools	No	50		85.2	370.7	0.0
Welder / Torch	No	40		74.0	370.7	0.0

Results

Noise Limit Exceedance (dBA) Noise Limits (dBA)

Night	Day	Calculated (dBA)			Day		Evening	
		Lmax	L10	Lmax	L10	Lmax	L10	
Equipment		Lmax	L10	Lmax	L10	Lmax	L10	L10
Concrete Mixer Truck			61.4	60.4	N/A	N/A	N/A	N/A
N/A	N/A	N/A	N/A	N/A	N/A	N/A	N/A	N/A
Concrete Pump Truck			64.0	60.0	N/A	N/A	N/A	N/A
N/A	N/A	N/A	N/A	N/A	N/A	N/A	N/A	N/A
Concrete Saw			72.2	68.2	N/A	N/A	N/A	N/A
N/A	N/A	N/A	N/A	N/A	N/A	N/A	N/A	N/A
Crane			63.1	58.2	N/A	N/A	N/A	N/A
N/A	N/A	N/A	N/A	N/A	N/A	N/A	N/A	N/A
Drum Mixer			62.6	62.6	N/A	N/A	N/A	N/A
N/A	N/A	N/A	N/A	N/A	N/A	N/A	N/A	N/A
Flat Bed Truck			56.8	55.9	N/A	N/A	N/A	N/A
N/A	N/A	N/A	N/A	N/A	N/A	N/A	N/A	N/A
Pneumatic Tools			67.8	67.8	N/A	N/A	N/A	N/A
N/A	N/A	N/A	N/A	N/A	N/A	N/A	N/A	N/A
Welder / Torch			56.6	55.6	N/A	N/A	N/A	N/A
N/A	N/A	N/A	N/A	N/A	N/A	N/A	N/A	N/A
		Total	72.2	72.5	N/A	N/A	N/A	N/A
N/A	N/A	N/A	N/A	N/A	N/A	N/A	N/A	N/A

**** Receptor #3 ****

Description	Land Use	Daytime	Baselines (dBA)	
			Evening	Night
NSL3	Residential	49.0	45.0	45.0

Equipment

Description	Impact Device	Usage (%)	Spec Lmax (dBA)	Actual Lmax (dBA)	Receptor Distance (feet)	Estimated Shielding (dBA)
Concrete Mixer Truck	No	40		78.8	1148.3	0.0
Concrete Pump Truck	No	20		81.4	1148.3	0.0
Concrete Saw	No	20		89.6	1148.3	0.0
Crane	No	16		80.6	607.0	0.0

Concrete & Steel Noise Model					
Drum Mixer	No	50	80.0	607.0	0.0
Flat Bed Truck	No	40	74.3	607.0	0.0
Pneumatic Tools	No	50	85.2	607.0	0.0
Welder / Torch	No	40	74.0	607.0	0.0

Results

Noise Limit Exceedance (dBA) Noise Limits (dBA)

Night		Calculated (dBA)			Day		Evening		
		Day	Evening	Evening	Day	Night	Day	Night	
Lmax	L10	Lmax	L10	Lmax	L10	Lmax	L10	Lmax	L10
Concrete Mixer Truck		51.6	50.6	N/A	N/A	N/A	N/A	N/A	N/A
N/A	N/A	N/A	N/A	N/A	N/A	N/A	N/A	N/A	N/A
Concrete Pump Truck		54.2	50.2	N/A	N/A	N/A	N/A	N/A	N/A
N/A	N/A	N/A	N/A	N/A	N/A	N/A	N/A	N/A	N/A
Concrete Saw		62.4	58.4	N/A	N/A	N/A	N/A	N/A	N/A
N/A	N/A	N/A	N/A	N/A	N/A	N/A	N/A	N/A	N/A
Crane		58.9	53.9	N/A	N/A	N/A	N/A	N/A	N/A
N/A	N/A	N/A	N/A	N/A	N/A	N/A	N/A	N/A	N/A
Drum Mixer		58.3	58.3	N/A	N/A	N/A	N/A	N/A	N/A
N/A	N/A	N/A	N/A	N/A	N/A	N/A	N/A	N/A	N/A
Flat Bed Truck		52.6	51.6	N/A	N/A	N/A	N/A	N/A	N/A
N/A	N/A	N/A	N/A	N/A	N/A	N/A	N/A	N/A	N/A
Pneumatic Tools		63.5	63.5	N/A	N/A	N/A	N/A	N/A	N/A
N/A	N/A	N/A	N/A	N/A	N/A	N/A	N/A	N/A	N/A
Welder / Torch		52.3	51.3	N/A	N/A	N/A	N/A	N/A	N/A
N/A	N/A	N/A	N/A	N/A	N/A	N/A	N/A	N/A	N/A
Total		63.5	66.4	N/A	N/A	N/A	N/A	N/A	N/A
N/A	N/A	N/A	N/A	N/A	N/A	N/A	N/A	N/A	N/A

APPENDIX E

Orcem Mechanical Plant Data Sheets

PRESTATIONS DEMANDEES

Fluide véhiculé	: Air propre	Piloté par variateur de fréquence	: NON
Zone Intérieur ventilateur	: HORS ZONE ATEX	Altitude du site	: 0 m
Zone Extérieur ventilateur	: HORS ZONE ATEX		
Lieu d'installation du ventilateur	: Extérieur	Température de fonctionnement	: 70 °C
Débit	: 4000 m3/h	Prestations demandées à	: 70 °C
		Masse volumique à 70 °C	: 0,987 kg/m3
Pst Aspiration	: 400 daPa	Température ambiante mini	: -20 °C
Pression atmosphérique	: 101000 Pa	Température ambiante maxi	: 40 °C

VENTILATEUR PROPOSE

Modèle : **MV 560 A 4 CL2 SV**
 Type de construction : Centrifuge simple ouïe , Pales courbes incurvées en arrière, Entraînement direct, turbine montée directement sur le bout d'arbre moteur; moteur à pattes B3, avec chaise

Arrangement	: 4	Moment d'inertie turbine	: 2,600 kgfm2
Classe	: CL2	Bride aspiration	: 285 mm
Zone ventilateur	: HORS ZONE ATEX	Cadre refoulement	: 258 x 185 mm
Orientation	: Non précisée	Section refoulement	: 0,048 m2
Vitesse ventilateur	: 2935 tr/min	Vitesse du fluide au refoulement	: 23,28 m/s
Rendement	: 82%	Temps de démarrage indicatif	: 16 s

	15 °C	70 °C
Température du fluide	15 °C	70 °C
Masse volumique	1,224 kg/m3	1,028 kg/m3
Débit	4000 m3/h	4000 m3/h
Pression totale	542 daPa	455 daPa
Pression dynamique	33 daPa	28 daPa
Pression statique	509 daPa	427 daPa
Puissance absorbée aéraulique	7,32 kW	6,1 kW
Puissance électrique mini	7,69 kW	6,5 kW
Temp. du fluide au refoulement	20 °C	75 °C

Distance de mesure	1,5 m	
Bouche raccordées	Lp 82 dB(A) ± 3dB(A)	Lw 94 dB
Bouche libre	Lp 91 dB(A) ± 3dB(A)	Lw 103 dB
Avec silencieux sur bouche libre	Lp 80 dB(A) ± 3dB(A)	

SPECTRE SONORE

A / @

Fréquence fm en Hz	15 °C								70 °C							
	63	125	250	500	1 K	2 K	4 K	8 K	63	125	250	500	1 K	2 K	4 K	8 K
Lwg en dB	110															
Lwrel en dB	-2	-7	-12	-17	-22	-27	-32	-37	-2	-7	-12	-17	-22	-27	-32	-37
Lwoct en dB	108	103	98	93	88	83	78	73	107	102	97	92	87	82	77	72
Pondération A	-26	-16	-9	-3	0	1	1	-1	-26	-16	-9	-3	0	1	1	-1
LWA oct.en dB	82	87	90	90	88	84	79	72	80	86	88	88	87	83	78	71
LWAa oct. en dB	69	74	76	77	75	71	66	59	67	72	75	75	73	69	64	57
LPA-okt en dB(A)	52	57	59	60	58	54	49	42	50	55	58	58	56	52	47	40

MOTEUR

Puissance installée	: Calculé pour un dém. à 15 °C
Fourniture	: Votre fourniture
Forme	: B3
Puissance	: 11,00 kW
Pôles	: 2 2935 tr/min
Hauteur d'axe HA	: 160
Fréquence	: 60 Hz

PRESTATIONS DEMANDEES

Fluide véhiculé	: Air propre	Piloté par variateur de fréquence	: NON
Zone Intérieur ventilateur	: HORS ZONE ATEX	Altitude du site	: 0 m
Zone Extérieur ventilateur	: HORS ZONE ATEX		
Lieu d'installation du ventilateur	: Extérieur	Température de fonctionnement	: 70 °C
Débit	: 50000 m3/h	Prestations demandées à	: 70 °C
		Masse volumique à 70 °C	: 0,987 kg/m3
Pst Aspiration	: 400 daPa	Température ambiante mini	: -20 °C
Pression atmosphérique	: 101000 Pa	Température ambiante maxi	: 40 °C

VENTILATEUR PROPOSE

Modèle	: MG 1250 A 12 CL2 SF															
Type de construction	: Centrifuge simple ouïe , Pales courbes incurvées en arrière, Entraînement par poulie-courroie, turbine montée sur arbre palier, moteur à patte B3 monté sur glissières et châssis															
Arrangement	: 12	Moment d'inertie turbine	: 161,000 kgfm2													
Classe	: CL2	Bride aspiration	: 805 mm													
Zone ventilateur	: HORS ZONE ATEX	Cadre refoulement	: 801 x 569 mm													
Orientation	: Non précisée	Section refoulement	: 0,456 m2													
Vitesse ventilateur	: 1470 tr/min	Vitesse du fluide au refoulement	: 30,47 m/s													
Rendement	: 90%	Temps de démarrage indicatif	: 25 s													
Température du fluide	: 15 °C		70 °C													
Masse volumique	: 1,224 kg/m3		1,028 kg/m3													
Débit	: 50000 m3/h		50000 m3/h													
Pression totale	: 553 daPa		465 daPa													
Pression dynamique	: 57 daPa		48 daPa													
Pression statique	: 496 daPa		417 daPa													
Puissance absorbée aéraulique	: 85,33 kW		71,6 kW													
Puissance électrique mini	: 98,13 kW		82,4 kW													
Temp. du fluide au refoulement	: 20 °C		75 °C													
Distance de mesure	1,5 m															
Bouche raccordées	Lp 94 dB(A) ± 3dB(A)	Lw	105 dB													
Bouche libre	Lp 103 dB(A) ± 3dB(A)	Lw	114 dB													
Avec silencieux sur bouche libre	Lp 92 dB(A) ± 3dB(A)															
SPECTRE SONORE																
A / @	15 °C		70 °C													
Fréquence fm en Hz	63 125 250 500 1 K 2 K 4 K 8 K		63 125 250 500 1 K 2 K 4 K 8 K													
Lwg en dB	121								119							
Lwrel en dB	-9 -8 -7 -12 -17 -22 -27 -32		-9 -8 -7 -12 -17 -22 -27 -32													
Lwoct en dB	112 113 114 109 104 99 94 89		110 111 112 107 102 97 92 87													
Pondération A	-26 -16 -9 -3 0 1 1 -1		-26 -16 -9 -3 0 1 1 -1													
LWA oct.en dB	86 97 105 106 104 100 95 88		84 95 104 104 102 99 93 86													
LWAa oct. en dB	72 83 92 92 91 87 82 74		71 82 90 91 89 85 80 73													
LPA-okt en dB(A)	52 63 71 72 70 66 61 54		50 61 70 70 68 65 59 52													

MOTEUR

Puissance installée	: Calculé pour un dém. à 15 °C
Fourniture	: Votre fourniture
Forme	: B3
Puissance	: 110,00 kW
Pôles	: 4 1482 tr/min
Hauteur d'axe HA	: 315
Fréquence	: 60 Hz

PRESTATIONS DEMANDEES

Fluide véhiculé	: Air propre	Piloté par variateur de fréquence	: NON
Zone Intérieur ventilateur	: HORS ZONE ATEX	Altitude du site	: 0 m
Zone Extérieur ventilateur	: HORS ZONE ATEX		
Lieu d'installation du ventilateur	: Extérieur	Température de fonctionnement	: 70 °C
Débit	: 20000 m3/h	Prestations demandées à	: 70 °C
		Masse volumique à 70 °C	: 0,987 kg/m3
Pst Aspiration	: 400 daPa	Température ambiante mini	: -20 °C
Pression atmosphérique	: 101000 Pa	Température ambiante maxi	: 40 °C

VENTILATEUR PROPOSE

Modèle	: MG 800 A 12 CL2 SF															
Type de construction	: Centrifuge simple ouïe , Pales courbes incurvées en arrière, Entraînement par poulie-courroie, turbine montée sur arbre palier, moteur à patte B3 monté sur glissières et châssis															
Arrangement	: 12	Moment d'inertie turbine	: 18,100 kgfm2													
Classe	: CL2	Bride aspiration	: 505 mm													
Zone ventilateur	: HORS ZONE ATEX	Cadre refoulement	: 507 x 361 mm													
Orientation	: Non précisée	Section refoulement	: 0,183 m2													
Vitesse ventilateur	: 2280 tr/min	Vitesse du fluide au refoulement	: 30,35 m/s													
Rendement	: 86%	Temps de démarrage indicatif	: 17 s													
Température du fluide	: 15 °C		70 °C													
Masse volumique	: 1,224 kg/m3		1,028 kg/m3													
Débit	: 20000 m3/h		20000 m3/h													
Pression totale	: 553 daPa		464 daPa													
Pression dynamique	: 56 daPa		47 daPa													
Pression statique	: 497 daPa		417 daPa													
Puissance absorbée aéraulique	: 35,73 kW		30,0 kW													
Puissance électrique mini	: 41,09 kW		34,5 kW													
Temp. du fluide au refoulement	: 20 °C		75 °C													
Distance de mesure	1,5 m															
Bouche raccordées	Lp 90 dB(A) ± 3dB(A)	Lw 101 dB														
Bouche libre	Lp 99 dB(A) ± 3dB(A)	Lw 110 dB														
Avec silencieux sur bouche libre	Lp 88 dB(A) ± 3dB(A)															
SPECTRE SONORE																
A / @	15 °C		70 °C													
Fréquence fm en Hz	63 125 250 500 1 K 2 K 4 K 8 K		63 125 250 500 1 K 2 K 4 K 8 K													
Lwg en dB	117								115							
Lwrel en dB	-9 -8 -7 -12 -17 -22 -27 -32		-9 -8 -7 -12 -17 -22 -27 -32													
Lwoct en dB	108 109 110 105 100 95 90 85		106 107 108 103 98 93 88 83													
Pondération A	-26 -16 -9 -3 0 1 1 -1		-26 -16 -9 -3 0 1 1 -1													
LWA oct.en dB	82 93 101 102 100 96 91 84		80 91 100 100 98 95 89 82													
LWAa oct. en dB	68 79 88 88 87 83 78 70		67 78 86 87 85 81 76 69													
LPA-okt en dB(A)	49 60 69 69 68 64 59 51		48 59 67 68 66 62 57 50													

MOTEUR

Puissance installée	: Calculé pour un dém. à 15 °C
Fourniture	: Votre fourniture
Forme	: B3
Puissance	: 45,00 kW
Pôles	: 4 1483 tr/min
Hauteur d'axe HA	: 225
Fréquence	: 60 Hz

Donaldson®
Torit®

DALAMATIC®
DUST COLLECTORS

DURA-LIFE™
Twice The Life Filter Bags



PROVEN PERFORMANCE, COMPACT DESIGN

The versatile Donaldson® Torit® Dalamatric series of dust collectors deliver a powerful solution for nearly any dust filtration application. These collectors come in two models: the Dalamatric Cased (DLMC) is a stand alone collector that can be ducted to many different applications; the Dalamatric Insertable (DLMV) is a versatile collector that can be inserted into various applications, such as bins, silos, bunkers, storage vessels or transfer points. Both models are continuous-duty dust collectors designed to handle the most difficult product recovery applications.

The Dalamatric Features:

- **CONTINUOUS COLLECTION**
Provides continuous filtration of high dust concentrations at high filtration velocities and constant levels of resistance in almost any industry and application.
- **COMPACT DESIGN**
Unique modular design allows for installation in the most space restricted areas. Envelope-shaped bags maximize the amount of media in a given space and allow for increased space between bags, minimizing the chances of bridging.
- **DURA-LIFE™ BAG FILTERS**
Provide better surface loading and better pulse cleaning reducing maintenance and operating costs.
- **VERSATILITY**
A full range of sizes and types of bags are available for a wide variety of dust collection applications.
- **10-YEAR WARRANTY**



DLMC 3/7/15

SIMPLY THE BEST

DUST COLLECTORS AVAILABLE
with Dura-Life™ Twice the Life Bag Filters

FLEXIBLE, EFFECTIVE FILTER MEDIA

UNIQUE BAG DESIGN

The Dalamatic advantage is found in the breakthrough technology of Dura-Life bag filters in an envelope shape. The envelope shape provides greater movement of the bag to dislodge more challenging dust cakes during filter pulsing.

- Dust accumulates on the outer surface of the filter bag as air penetrates the media.
- The blowpipe (jet tube) injects a burst of compressed air into the bag filter.
- Airflow is then briefly reversed, inflating the bag filter and dislodging dust.
- The dislodged dust cake falls into the collection hopper for final removal or directly back in the process. The envelope-shaped bag filter, which is mounted on a unique wire frame, ensures optimum airflow and thorough cleaning.



DLMV 45/15

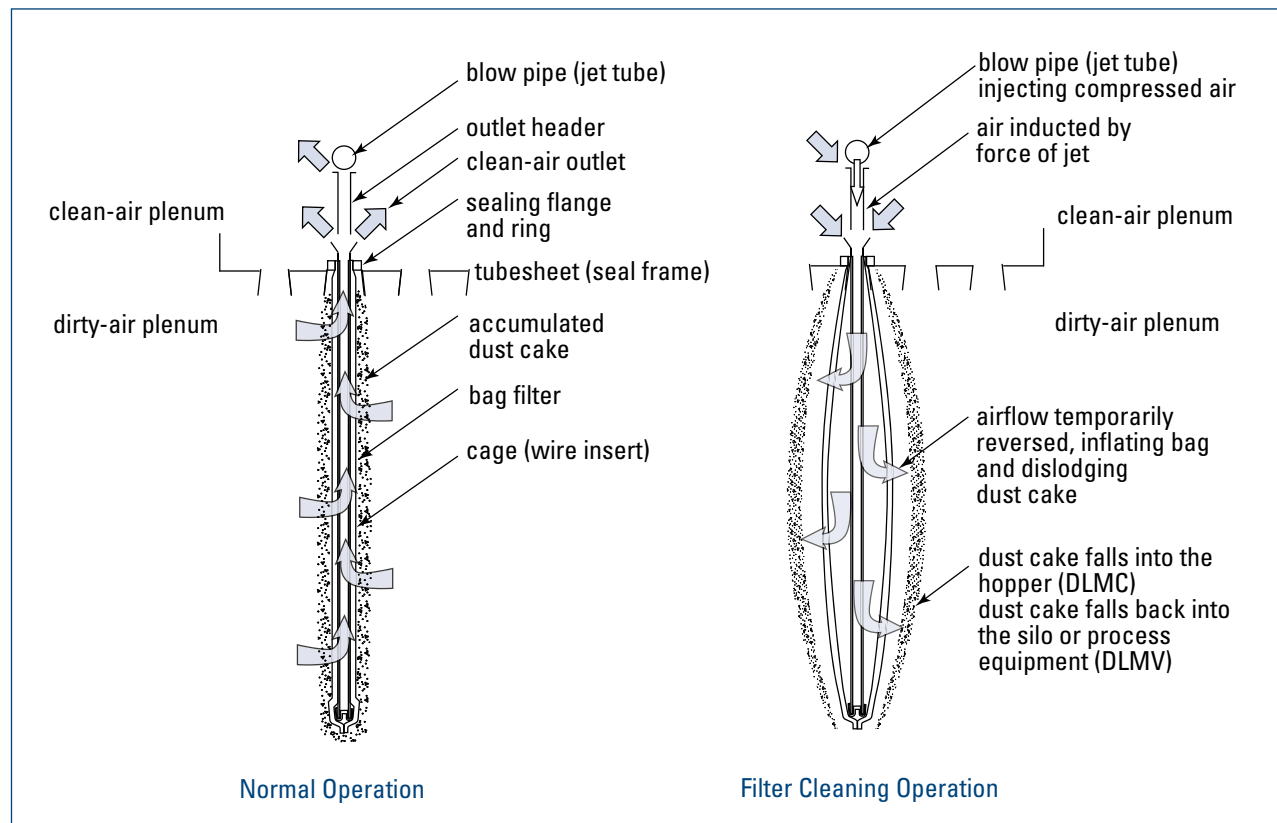

PRINCIPLES OF FILTRATION

SIZES & OPERATIONS

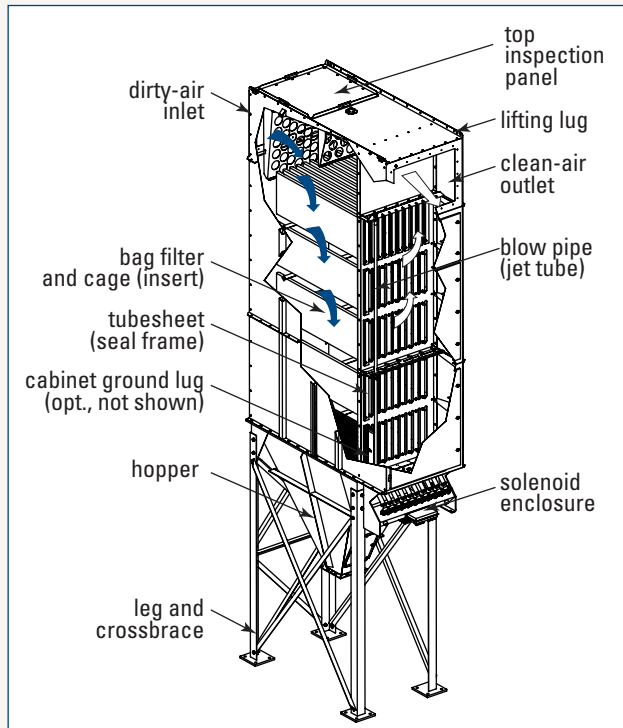

NORMAL OPERATION FOR MODELS DLMC

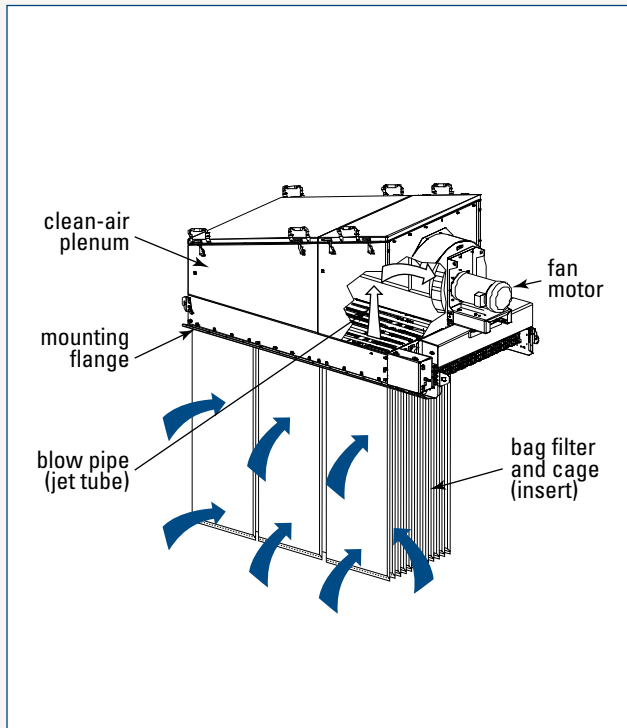

NORMAL OPERATION FOR MODELS DLMV

DALAMATIC CASED (DLMC)

- Envelope-shaped bags provide maximum filter area per given space and ensure efficient cleaning
- Air volumes range from 1500 to 85,000 cfm
- Modular design gives dimensional and capacity flexibility
- Downward airflow pattern minimizes dust re-entrainment
- Side doors provide easy, clean side access to filters.
- Standard leg pack meets IBC 2003 requirements

DALAMATIC INSERTABLE (DLMV)

- Five configurations to suit most process applications
- Uses positive pressure of the conveying air or can be fan powered for pneumatic conveying applications
- Bags can be installed hanging vertically, horizontally or any angle in between
- Can be inserted into hood enclosures at belt transfer points, bucket elevator casings, ribbon blenders and receiving hoppers for clamshell unloaders
- Insertable approach reduces or eliminates ducting costs; minimized ducting can also result in reduced energy costs

DURA-LIFE™ — A TECHNOLOGY BREAKTHROUGH FOR BAG USERS

STANDARD IN ALL DONALDSON TORIT DALAMATIC BAGHOUSE COLLECTORS

Traditional 16 oz. polyester bags are produced with a needling process that creates larger pores where dust can embed into the fabric, inhibiting cleaning and reducing bag life. Dura-Life bags are engineered with a unique hydroentanglement process that uses water to blend the fibers. This process provides a more uniform material with smaller pores, better surface loading, and better cleaning. These advantages provide twice the operating life before bags need to be replaced due to high pressure drop. Longer life from Dura-Life bags lowers maintenance and operating costs and raises baghouse dust collection to a whole new level.



Dura-Life Bag-Clean Air Side
(300x)



Polyester Bag-Clean Air Side
(300x)

These photos were taken with a scanning electron microscope of bag media used in a collector that was filtering fly ash. The bags were removed after 2,700 hours of use. Air-to-media ratio was 4.5 to 1. Pressure drop was 6 in. on polyester bags and 2 in. on Dura-Life.

DURA-LIFE BAGS PROVIDE BIG BENEFITS

Dura-Life technology provides better surface loading and better pulse cleaning, resulting in:

- Two to three times longer bag life
- Energy savings due to lower pressure drop
- Reduced replacement bag costs due to fewer bag changeouts
- Reduced maintenance and operating costs due to fewer bag changeouts
- 30% fewer emissions based on EPA tests

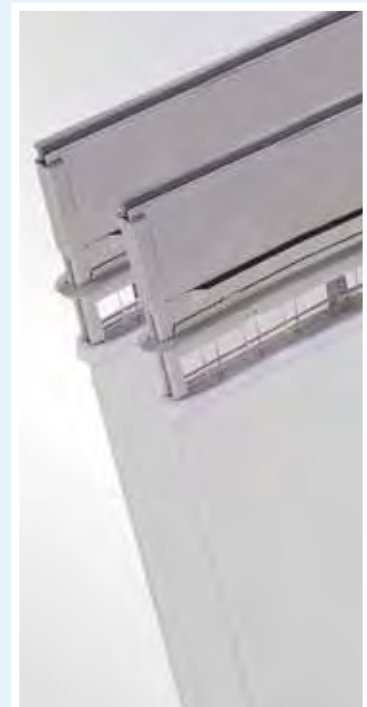

CASED DIMENSIONS & SPECIFICATIONS

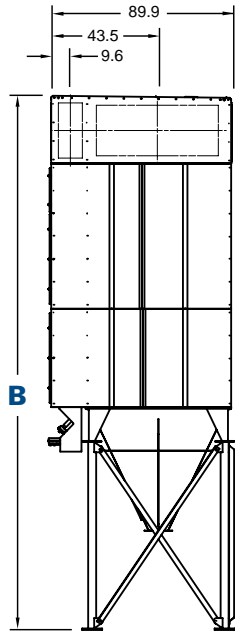

Side View
Pyramid Hopper
(2/5/15 Model)

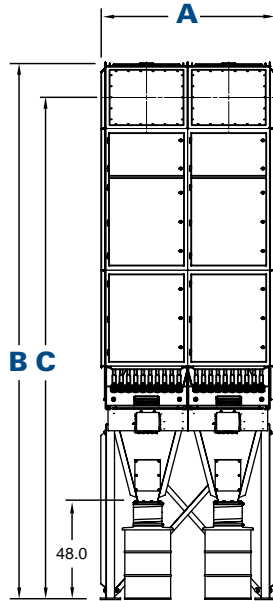

Pyramid Hopper*
(2/5/15 Model)

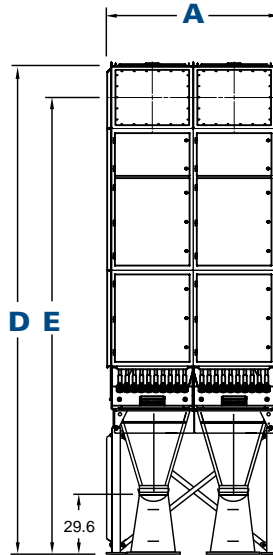

UMA Hopper
(2/5/15 Model with
4 cu. ft. Bins)

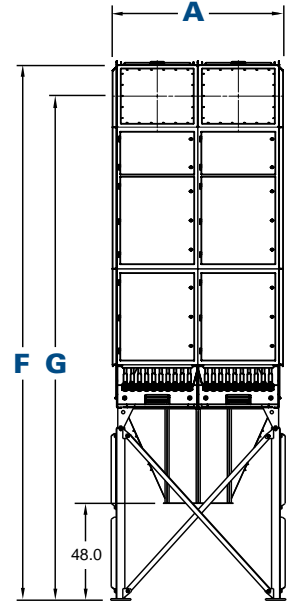

Trough Hopper
(2/5/15 Model)

DLMC Model	Nominal Airflow Range (cfm)**	Cloth Area (ft ²)	No. of Banks	No. of Tiers	No. of Bags	No. of Valves	Shipping Weight (lbs)		
							With Pyramid Hopper	With Hopper for UMA 4 cu. ft. Bin	With Trough Hopper
1/2/15	1,290 - 3,550	323	1	2	20	10	2,810	2,630	N/A
1/3/15	1,940 - 5,335	485	1	3	30	10	3,147	2,971	N/A
1/4/15	2,580 - 7,095	645	1	4	40	10	3,705	3,600	N/A
2/2/15	2,580 - 7,095	645	2	2	40	20	4,220	3,495	4,100
1/5/15	3,240 - 8,910	810	1	5	50	10	4,130	3,950	N/A
2/3/15	3,880 - 10,670	970	2	3	60	20	4,890	4,750	4,910
1/7/15	4,520 - 12,430	1,130	1	7	70	10	5,300	5,100	N/A
2/4/15	5,160 - 14,190	1,290	2	4	80	20	6,100	5,800	5,960
3/3/15	5,815 - 15,990	1,454	3	3	90	30	7,100	6,740	6,700
2/5/15	6,480 - 17,820	1,620	2	5	100	20	7,065	6,770	6,940
2/6/15	7,750 - 21,315	1,938	2	6	120	20	8,015	7,720	7,890
3/5/15	9,690 - 26,650	2,423	3	5	150	30	9,950	9,590	9,545
2/8/15	10,335-28,420	2,584	2	8	160	20	9,550	9,255	9,420
3/6/15	11,625 - 31,975	2,907	3	6	180	30	11,360	11,000	10,955
4/5/15	12,920 - 35,530	3,230	4	5	200	40	12,670	12,185	11,862
3/7/15	13,565 - 37,310	3,392	3	7	210	30	12,470	12,110	12,065
3/8/15	15,500 - 42,635	3,876	3	8	240	30	13,595	13,235	13,200
4/8/15	20,670 - 56,845	5,168	4	8	320	40	17,765	17,280	16,960

* With optional 55-gallon drum adapter (drum not included).

** Based on clean filters.

CASED DIMENSIONS & SPECIFICATIONS

DLMC Model	Dimensions (inches)						
	A	Pyramid		UMA		Trough	
		B	C	D	E	F	G
1/2/15	45.5	175.7	162.7	151.9	138.9	N/A	N/A
1/3/15	45.5	198.5	185.5	174.7	161.7	N/A	N/A
1/4/15	45.5	238.2	216.8	214.4	193.0	N/A	N/A
1/5/15	45.5	263.0	241.6	239.2	217.8	N/A	N/A
1/7/15	45.5	308.7	287.3	284.9	263.5	N/A	N/A
2/2/15	85.0	175.7	162.7	151.9	138.9	169.7	156.7
2/3/15	85.0	198.5	185.5	174.7	161.7	192.5	179.5
2/4/15	85.0	238.2	216.8	214.4	193.0	232.8	210.7
2/5/15	85.0	263.0	241.6	239.2	217.8	257.0	235.6
2/6/15	85.0	285.9	264.4	262.1	240.7	279.8	258.4
2/8/15	85.0	331.5	310.1	307.7	286.3	325.5	304.1
3/3/15	124.4	198.5	185.5	174.4	138.9	192.5	179.5
3/5/15	124.4	263.0	241.6	239.2	217.8	257.0	235.6
3/6/15	124.4	285.9	264.4	262.1	240.7	279.8	258.4
3/7/15	124.4	308.7	287.3	284.9	263.5	302.7	281.2
3/8/15	124.4	331.5	310.1	307.7	286.3	325.5	304.1
4/5/15	166.4	263.1	241.6	239.2	217.8	257.0	235.6
4/8/15	166.4	331.5	310.1	307.7	286.3	325.5	304.1

DLMC Operating Conditions	Standard	Optional
Seismic Spectral Acceleration	$S_S = 1.5$ & $S_1 = 0.6$	–
Wind Load Rating (mph)	90	–
Housing Rating ("wg)	0-20	21-45
Compressed Air Required (psig)	55-90	–
Temperature Range	15°F to 140°F	140°F to 400°F

INSERTABLE DIMENSIONS & SPECIFICATIONS

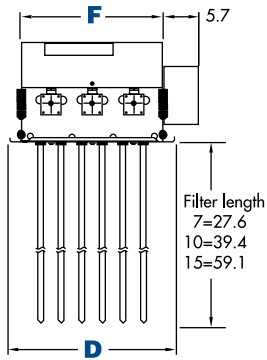

DLMV Type B
Basic filter for pressure systems located indoors.

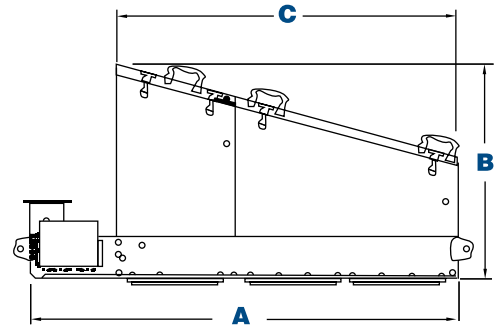
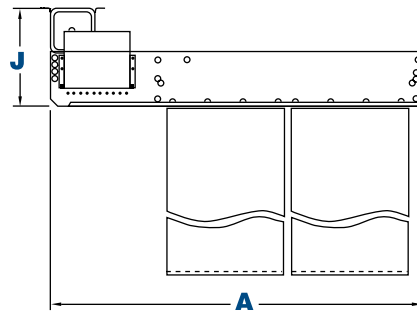

DLMV Type H
(Type B plus exit header)
Filter with exit header for connection to a fan or discharge ducting. The filter is weatherproof and suitable for indoor and outdoor application.

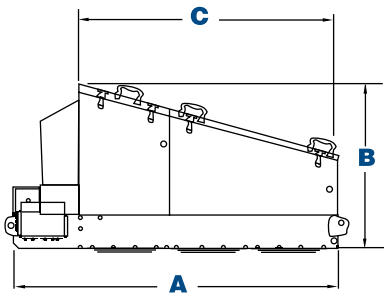

DLMV Type W
(Type H plus weather cowl)
Filter with a weather cowl for pressure systems where the filter is located outdoors or exposed to adverse conditions.

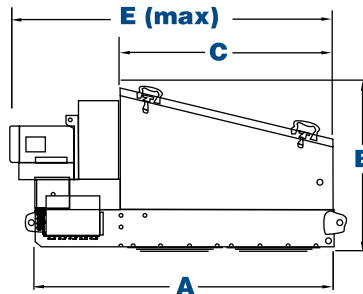

DLMV Type F
(Type H plus integral fan)
Weatherproof filter fitted with an integral fan for negative pressure applications.

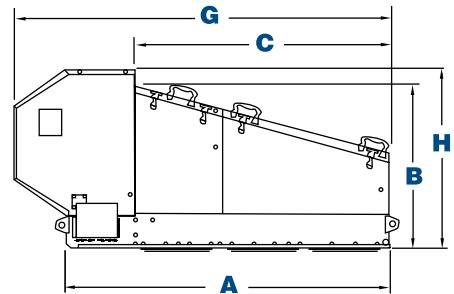

DLMV Type FAD
(Type F plus acoustic diffuser)
Weatherproof filter fitted with an integral fan and acoustic diffuser for quiet operation.

DLMV Model	No. of Banks	Dimensions (inches)								
		A	B	C	D	E	F	G	H	J
4/7, 6/10, 9/15	6	38.3	36.8	33.8	27.5	43.1	29.1	57.4	43.3	14.7
7/7, 10/10, 15/15	10	38.3	36.8	33.8	43.3	43.1	39.8	57.4	43.3	14.7
8/7, 12/10, 18/15	12	62.2	36.8	44.5	27.6	64.0	29.1	71.6	43.3	15.7
14/7, 20/10	20	62.3	36.8	44.5	43.3	67.0	39.8	71.7	43.3	15.8
30/15	20	62.3	37.6	44.5	43.3	68.4	39.8	71.7	43.3	15.8
21/7, 30/10, 45/15	30	85.9	42.9	68.1	43.3	93.1	39.8	100.0	46.8	15.8
60/15	40	112.2	42.9	88.8	43.3	113.3	39.8	120.7	46.8	15.8

INSERTABLE DIMENSIONS & SPECIFICATIONS

DLMV Model	Nominal Airflow Range (cfm)*	Cloth Area (ft ²)	4:1 cfm	6:1 cfm	8:1 cfm	No. of Valves	Fan	Motor (hp)	Shipping Weight (lbs)				
									Type B	Type H	Type W	Type F	Type FAD
4/7	215 - 555	43	172	258	344	3	F1	1	231	320	331	430	523
6/10	320 - 830	64	256	384	512	3	F1	1	251	340	351	450	543
7/7	375 - 975	75	300	450	600	5	F1 K3	1 2	353	474	485	584 595	688 699
8/7	430 - 1,115	86	344	516	688	6	F1 K3	1 2	375	518	529	628 640	727 739
9/15	485 - 1,260	97	388	582	776	3	F1 K3	1 2	273	362	373	472 483	565 576
10/10	540 - 1,400	108	432	648	864	5	F1 K3	1 2	386	507	519	617 628	721 732
12/10	645 - 1,675	129	516	774	1,032	6	K3 K5	2 3	414	558	569	679 712	778 811
14/7	750 - 1,950	150	600	900	1,200	5	K3 K5	2 3	606	794	805	915 948	1025 1058
15/15	805 - 2,090	161	644	966	1,288	5	K3 K5	2 3	423	545	556	666 699	770 803
18/15	970 - 2,520	194	776	1,164	1,552	6	K3 K5 K7	2 3 5	459	602	613	723 756 833	822 855 932
20/10	1,075 - 2,795	215	860	1,290	1,720	5	K3 K5 K7	2 3 5	672	860	871	981 1,014 1,091	1,091 1,124 1,201
21/7	1,130 - 2,935	226	904	1,356	1,808	10	K3 K5 K7	2 3 5	794	1,058	1,080	1,179 1,213 1,290	1,307 1,341 1,418
30/10	1,615 - 4,195	323	1,292	1,938	2,584	10	K5 K7 K10	3 5 7.5	893	1,157	1,179	1,312 1,389 1,561	1,440 1,517 1,689
30/15	1,615 - 4,195	323	1,292	1,938	2,584	10	K5 K7 K10	3 5 7.5	750	935	946	1,089 1,168 1,321	1,199 1,278 1,431
45/15	2,420 - 6,290	484	1,936	2,904	3,872	10	K7 K10 K11	5 7.5 10	1,003	1,268	1,290	1,499 1,671 1,758	1,627 1,799 1,886
60/15	3,230 - 8,395	646	2,584	3,876	5,168	10	K11	10	1,323	1,878	1,900	2,374	2,506

DLMV Operating Conditions	Standard	Optional
Pressure Limits	Type B, W and H: -16 "wg Type F: As fan performance curves from shut-off to ambient pressure	—
Compressed Air Required (psig)	65-90	—
Temperature Range	14°F to 140°F	140°F to 250°F (not Type F)

* Based on clean filters.

INSERTABLE PERFORMANCE SELECTIONS

TO SELECT THE MOST SUITABLE FAN FOR YOUR APPLICATIONS

- Determine the air volume flow (cfm) needed to give effective venting and dust control
- Estimate pressure or suction ("wg) in the housing in which the dust filter is inserted
- Assess the operational pressure drop ("wg) across the clean side and dirty side of the filtering element – usually between 2 to 4 "wg
- The sum of 2 and 3 gives the pressure ("wg) required for fan selection purposes
- Consult graph for fan performance available

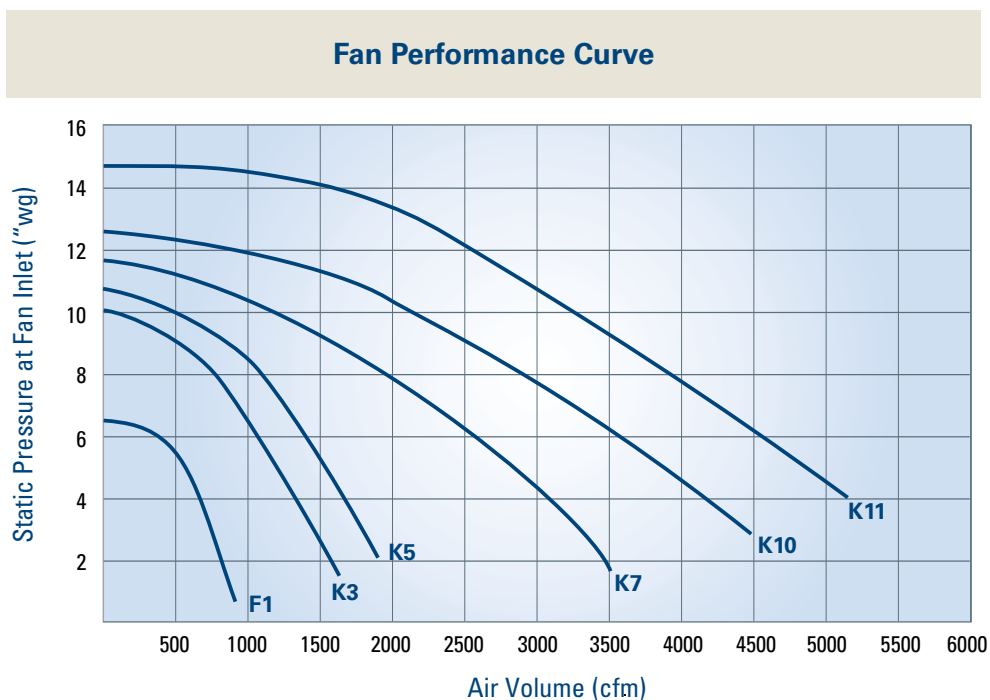

INSERTABLE WEIGHTED SOUND PRESSURE LEVELS

All readings were taken in semi-reverberant surroundings 3'3" radius from the equipment housing and 5'3" above base level, using a precision sound level meter and octave filter.

	F1 (1 hp)	K3 (2 hp)	K5 (3 hp)	K7 (5 hp)	K10 (7.5 hp)	K11 (10 hp)
With acoustic diffuser*	76 dB(A)	73 dB(A)	74 dB(A)	76 dB(A)	79 dB(A)**	84 dB(A)
Without acoustic diffuser	91 dB(A)	89 dB(A)	92 dB(A)	93 dB(A)	94 dB(A)	97 dB(A)

Noise measurements of installed equipment may vary due to site conditions.

* These measurements refer to standard outlet position.

** Estimated data.

STANDARD FEATURES & AVAILABLE OPTIONS

DALAMATIC CASED (DLMC)

Collector Design	Std	Opt
Mild Steel Construction	X	
Horizontal Clean-Side Bag Removal	X	
Rear Dirty-Air Plenum Access Door		X
High Temperature Construction		X
Stainless Steel Construction		X
Mountable Fan		X
Ladders, Cages, & Platform Assemblies (OSHA compliant)		X
Bags & Cages		
Dura-Life Twice the Life Polyester Felt Bags	X	
Quick-Release Filter Clamps		X
Variety of Bag Media Options		X
Anti-Static Bag Filters		X
Paint System		
Powder-Coated Polyester Textured Finish	X	
Blue Exterior Finish Coating Meets 250-Hour Salt Spray Corrosion Protection Test	X	
Hostile Environment Paint		X
Custom Colors		X
Hopper Design		
Pyramid Hoppers	X	
Trough Hoppers	X	
2 and 3 Bank Single-Outlet Hopper	X	
UMA Hopper		X
Support Structure		
Standard Leg Pack	X	
Leg Extensions		X
Electrical Controls, Gauges & Enclosures		
Solid-State Control Panels and Valves in NEMA 4 Encl.	X	
Solid-State Control Panels and Valves in NEMA 9 Encl.		X
Control Panels and Valves with Heater in NEMA 9 Encl.		X
Magnehelic®* Gauge		X
Solenoid Enclosure NEMA 9		X
Photohelic®* Gauge		X
Delta P Control, Delta P Plus Control		X
Compressed Air Filter and Regulator		X
Safety Features		
Sprinkler Pack		X
Explosion Vents		X
Warranty		
10-Year Warranty	X	

DALAMATIC INSERTABLE (DLMV)

Collector Design	Std	Opt
Mild Steel Construction	X	
Horizontal or Vertical Bag Removal	X	
High Temperature Construction		X
Stainless Steel Construction		X
Acoustic Diffuser Silencers		X
Fans (AMCA "C" Rated) and Motors**		X
Bags & Cages		
Dura-Life Twice the Life Polyester Felt Bags	X	
Clean-Side Bag Removal	X	
Quick-Release Filter Clamps		X
Variety of Bag Media Options		X
Anti-Static Bag Filters		X
Oleophobic Bag Filters		X
Paint System		
Powder-Coated Polyester Texture	X	
Blue Exterior Finish Coating Meets 250-Hour Salt Spray Corrosion Protection Test	X	
Hostile Environment Paint		X
Custom Colors		X
Support Structure		
Vertical or Horizontal Upstands		X
Electrical Controls, Gauges & Enclosures		
Solid-State Control Panels and Valves in NEMA 4 Encl.	X	
Solid-State Control Panels and Valves in NEMA 9 Encl.		X
Control Panels and Valves with Heater in NEMA 9 Encl.		X
Magnehelic®* Gauge		X
Solenoid Enclosure NEMA 9		X
Photohelic®* Gauge		X
Delta P Control, Delta P Plus Control		X
Compressed Air Filter and Regulator		X
Safety Features		
Explosion Proof Motors		X
Warranty		
10-Year Warranty	X	

* Magnehelic and Photohelic are registered trademarks of Dwyer Instruments, Inc.

** All 60 Hz motors 1HP and above are compliant with EISA.



GLOBAL SUPPORT



- Facilities in 37 countries
- 40 manufacturing plants and 14 distribution centers
- Sales offices worldwide

LEADING TECHNOLOGY



- Over 1,000 engineers and scientists worldwide
- Broad range of innovative collectors and filters
- 100s of filter media formulations

EXPERIENCE & SERVICE



- Technical expertise and support
- Ready-to-ship filters and parts within 24 hours
- 1,000,000+ dust, fume, and mist collectors installed



**Call Donaldson Torit
to get Cleaner Air today
800-365-1331
donaldsontorit.com**

Process performance cast iron motors

Technical data for totally enclosed squirrel cage three phase motors

IE2

IP 55 – IC 411 – Insulation class F, temperature rise class B
IE2 efficiency class according to IEC 60034-30; 2008

Output kW	Motor type	Product code	Speed r/min	Efficiency IEC 60034-2-1; 2007			Power factor cos φ	Current		Torque			Moment of inertia J = 1/4 GD ² kgm ²	Weight kg	Sound pressure level L _{PA} dB
				Full load 100%	3/4 load 75%	1/2 load 50%		I _N A	I _s /I _N	T _N Nm	T _I /T _N	T _b /T _N			
1500 r/min = 4-poles			400 V 50 Hz				High-output design								
18.5	M3BP 160 MLC	3GBP 162 033-••G	1469	91.4	92.5	92.3	0.84	34.7	7.6	120	3	3.2	0.11	173	62
22	M3BP 160 MLD	3GBP 162 034-••G	1463	91.6	93	93.2	0.85	40.7	6.9	143	2.5	2.9	0.125	187	62
30 ¹⁾	M3BP 180 MLC	3GBP 182 033-••G	1474	92.3	93.5	93.5	0.83	56.5	7.3	194	2.7	2.9	0.217	235	62
37	M3BP 200 MLB	3GBP 202 032-••G	1479	93.4	94.4	94.4	0.85	67.2	7.1	238	2.6	2.9	0.343	307	63
45 ¹⁾	M3BP 200 MLC	3GBP 202 033-••G	1479	93.6	94.4	94.2	0.83	83.6	7.5	290	2.9	3.2	0.366	319	63
55	M3BP 225 SMC	3GBP 222 033-••G	1478	94	94.7	94.5	0.85	99.3	7.4	355	2.9	3.1	0.474	370	66
64	M3BP 225 SMD	3GBP 222 034-••G	1480	94.2	94.7	94.1	0.85	115	8.2	412	3.3	3.3	0.542	399	66
75 ¹⁾	M3BP 250 SMB	3GBP 252 032-••G	1478	94.4	95.1	94.9	0.85	134	7.3	484	2.8	3.1	0.866	450	67
90 ¹⁾	M3BP 250 SMC	3GBP 252 033-••G	1478	94.7	95.3	95	0.84	163	7.4	581	3.1	3.3	0.941	478	67
110	M3BP 280 SMC	3GBP 282 230-••G	1485	95.1	95.2	94.7	0.86	194	7.6	707	3	3	1.85	725	68
250	M3BP 315 LKA	3GBP 312 810-••G	1487	95.7	95.8	95.3	0.86	438	7.4	1605	2.5	2.9	4.4	1410	78
280	M3BP 315 LKB	3GBP 312 820-••G	1487	95.8	95.9	95.4	0.87	484	7.6	1798	2.6	3	5	1520	78
315	M3BP 315 LKC	3GBP 312 830-••G	1488	95.8	95.9	95.3	0.86	551	7.8	2021	2.6	3.2	5.5	1600	78

¹⁾ Temperature rise class F

The two bullets in the product code indicate choice of mounting arrangements, voltage and frequency code (see ordering information page).

I_s / I_N = Starting current
T_I / T_N = Locked rotor torque
T_b / T_N = Breakdown torque

Efficiency values are given according to IEC 60034-2-1; 2007.

Process performance cast iron motors

Technical data for totally enclosed squirrel cage three phase motors

IE2

IP 55 – IC 411 – Insulation class F, temperature rise class B
IE2 efficiency class according to IEC 60034-30; 2008

Output kW	Motor type	Product code	Speed r/min	Efficiency IEC 60034-2-1; 2007			Power factor cos φ	Current		Torque			Moment of inertia J = 1/4 GD ² kgm ²	Weight kg	Sound pressure level L _{PA} dB
				Full load 100%	3/4 load 75%	1/2 load 50%		I _N A	I _s / I _N	T _N Nm	T _I / T _N	T _b / T _N			
1000 r/min = 6-poles			400 V 50 Hz				GENELEC-design								
0.18	M3BP 71 MA	3GBP 073 321-••B	900	63.7	63.8	59	0.71	0.57	3.1	1.9	2	2.1	0.00089	10	42
0.25	M3BP 71 MB	3GBP 073 322-••B	895	67.2	67.2	62.6	0.69	0.77	3.4	2.6	2.2	2.3	0.0011	12	42
0.37	M3BP 80 MA	3GBP 083 321-••B	915	71	71.1	67	0.69	1.09	3.6	3.8	1.8	2.2	0.00187	15	47
0.55	M3BP 80 MB	3GBP 083 322-••B	920	73.9	75	72.8	0.71	1.51	3.8	5.7	1.8	2.2	0.00239	17	47
0.75	M3BP 90 SLC	3GBP 093 323-••B	960	78.7	77.3	72.5	0.58	2.3	4.5	7.4	2.3	3.1	0.00491	25	44
1.1	M3BP 90 SLE	3GBP 093 324-••B	930	78.2	78.6	76.4	0.66	3	4	11.2	1.9	2.3	0.0054	28	44
1.5	M3BP 100 L	3GBP 103 322-••B	950	82.2	82.9	81.6	0.69	3.8	4	15	1.5	1.1	0.00873	37	49
2.2	M3BP 112 MB	3GBP 113 322-••B	950	82.5	83.8	81.7	0.69	5.5	4.4	22.1	1.7	2.3	0.0125	44	66
3	M3BP 132 SMB	3GBP 133 321-••B	975	85.3	84.5	81.3	0.63	8	5.5	29.3	1.8	2.9	0.03336	69	57
4	M3BP 132 SMB	3GBP 133 322-••B	960	84.9	85.3	83.9	0.68	10	4.6	39.7	1.5	2.2	0.03336	69	57
5.5	M3BP 132 SMF	3GBP 133 324-••B	965	86.1	86.6	85.5	0.71	12.9	5.1	54.4	2	2.3	0.0487	86	57
7.5	M3BP 160 MLA	3GBP 163 031-••G	975	88.6	89.9	89.7	0.79	15.4	7.4	73.4	1.7	3.2	0.087	134	59
11	M3BP 160 MLB	3GBP 163 032-••G	972	89.3	90.7	90.6	0.79	22.5	7.5	108	1.9	2.9	0.114	172	59
15	M3BP 180 MLA	3GBP 183 031-••G	981	90.5	91.4	91	0.77	31	6.5	146	1.8	2.8	0.192	221	59
18.5	M3BP 200 MLA	3GBP 203 031-••G	988	91.6	92.3	91.7	0.8	36.4	6.7	178	2.3	2.9	0.382	269	63
22	M3BP 200 MLB	3GBP 203 032-••G	987	92	93	92.8	0.82	42	6.6	212	2.2	2.8	0.448	291	63
30	M3BP 225 SMA	3GBP 223 031-••G	986	92.7	93.3	92.9	0.83	56.2	7	290	2.6	2.9	0.663	349	63
37	M3BP 250 SMA	3GBP 253 031-••G	989	93.1	93.8	93.4	0.82	69.9	6.8	357	2.4	2.7	1.13	395	63
45	M3BP 280 SMA	3GBP 283 210-••G	990	93.4	93.6	93.1	0.84	82.7	7	434	2.5	2.5	1.85	605	66
55	M3BP 280 SMB	3GBP 283 220-••G	990	93.8	94	93.3	0.84	100	7	530	2.7	2.6	2.2	645	66
75	M3BP 315 SMA	3GBP 313 210-••G	992	94.4	94.4	93.5	0.82	139	7.4	721	2.4	2.8	3.2	830	70
90	M3BP 315 SMB	3GBP 313 220-••G	992	94.8	94.8	94.2	0.84	163	7.5	866	2.4	2.8	4.1	930	70
110	M3BP 315 SMC	3GBP 313 230-••G	991	95	95	94.6	0.83	201	7.4	1059	2.5	2.9	4.9	1000	70
132	M3BP 315 MLA	3GBP 313 410-••G	991	95.3	95.4	94.9	0.83	240	7.5	1271	2.7	3	5.8	1150	68
160	M3BP 355 SMA	3GBP 353 210-••G	993	95.4	95.4	94.8	0.83	291	7	1538	2	2.6	7.9	1520	75
200	M3BP 355 SMB	3GBP 353 220-••G	993	95.7	95.7	95.1	0.84	359	7.2	1923	2.2	2.7	9.7	1680	75
250	M3BP 355 SMC	3GBP 353 230-••G	993	95.7	95.7	95.1	0.83	454	7.4	2404	2.6	2.9	11.3	1820	75
315	M3BP 355 MLB	3GBP 353 420-••G	992	95.7	95.7	95.2	0.83	572	7	3032	2.5	2.7	13.5	2180	75
355	M3BP 355 LKA	3GBP 353 810-••G	992	95.7	95.7	95.1	0.83	645	7.6	3417	2.7	2.9	15.5	2500	75
400 ¹⁾	M3BP 355 LKB	3GBP 353 820-••G	992	96	96	95.5	0.83	724	7.2	3850	2.6	2.6	16.5	2600	75
400	M3BP 400 LA	3GBP 403 510-••G	993	96.2	96.3	95.8	0.82	731	7.1	3846	2.3	2.7	17	2900	76
400	M3BP 400 LKA	3GBP 403 810-••G	993	96.2	96.3	95.8	0.82	731	7.1	3846	2.3	2.7	17	2900	76
450	M3BP 400 LB	3GBP 403 520-••G	994	96.6	96.6	96.1	0.82	819	7.4	4323	2.4	2.8	20.5	3150	76
450	M3BP 400 LKB	3GBP 403 820-••G	994	96.6	96.6	96.1	0.82	819	7.4	4323	2.4	2.8	20.5	3150	76
500	M3BP 400 LC	3GBP 403 530-••G	993	96.6	96.7	96.2	0.83	900	7.2	4808	2.5	2.7	22	3300	76
500	M3BP 400 LKC	3GBP 403 830-••G	993	96.6	96.7	96.2	0.83	900	7.2	4808	2.5	2.7	22	3300	76
560	M3BP 400 LD	3GBP 403 540-••G	993	96.9	96.9	96.4	0.85	981	7.4	5385	2.4	2.8	24	3400	77
560	M3BP 400 LKD	3GBP 403 840-••G	993	96.9	96.9	96.4	0.85	981	7.4	5385	2.4	2.8	24	3400	77
630	M3BP 450 LA	3GBP 453 510-••G	994	96.7	96.8	96.4	0.84	1119	6.5	6052	1.1	2.5	31	4150	81
710	M3BP 450 LB	3GBP 453 520-••G	995	96.9	96.9	96.5	0.85	1244	7	6814	1.3	2.5	37	4500	81
800 ¹⁾	M3BP 450 LC	3GBP 453 530-••G	995	96.9	97	96.6	0.84	1418	7.2	7677	1.3	2.7	41	4800	81

¹⁾ Temperature rise class F

The two bullets in the product code indicate choice of mounting arrangements, voltage and frequency code (see ordering information page).

I_s / I_N = Starting current
T_I / T_N = Locked rotor torque
T_b / T_N = Breakdown torque

Efficiency values are given according to IEC 60034-2-1; 2007.

Process performance cast iron motors

Technical data for totally enclosed squirrel cage three phase motors

IE2

IP 55 – IC 411 – Insulation class F, temperature rise class B
IE2 efficiency class according to IEC 60034-30; 2008

Output kW	Motor type	Product code	Speed r/min	Efficiency IEC 60034-2-1; 2007			Power factor cos φ	Current		Torque			Moment of inertia J = 1/4 GD ² kgm ²	Weight kg	Sound pressure level L _{PA} dB
				Full load 100%	3/4 load 75%	1/2 load 50%		I _N A	I _s / I _N	T _N Nm	T _I / T _N	T _b / T _N			
1000 r/min = 6-poles			400 V 50 Hz				High-output design								
15	M3BP 160 MLC	3GBP 163 033-••G	971	89,7	91,2	91,2	0,77	31,3	7,3	147	1,8	3,6	0,131	185	59
30 ¹⁾	M3BP 200 MLC	3GBP 203 033-••G	985	92	93,1	92,9	0,83	56,7	6,9	290	2,3	2,8	0,531	318	63
37	M3BP 225 SMB	3GBP 223 034-••G	985	93,1	94	94	0,83	69,1	6,6	358	2,3	2,6	0,821	393	63
45	M3BP 250 SMB	3GBP 253 032-••G	989	93,4	94,1	93,9	0,83	83,7	7	434	2,5	2,7	1,369	441	63
45 ¹⁾	M3BP 225 SMC	3GBP 223 033-••G	984	92,7	93,9	94	0,83	84,4	6,4	436	2,3	2,6	0,821	393	63
55 ¹⁾	M3BP 250 SMC	3GBP 253 033-••G	988	93,2	94,1	94	0,84	101	7,1	531	2,6	2,8	1,5	468	63
75	M3BP 280 SMC	3GBP 283 230-••G	990	94,2	94,5	94,1	0,84	136	7,3	723	2,8	2,7	2,85	725	66
160	M3BP 315 LKA	3GBP 313 810-••G	992	95,3	95,3	94,7	0,83	291	7,5	1540	2,6	2,8	7,3	1410	74
180	M3BP 315 LKB	3GBP 313 820-••G	992	95,3	95,4	94,8	0,83	328	7,4	1732	2,6	2,8	8,3	1520	74
200	M3BP 315 LKC	3GBP 313 830-••G	989	95,4	95,6	95,3	0,85	355	6,8	1931	2,5	2,6	9,2	1600	74

¹⁾ Temperature rise class F

The two bullets in the product code indicate choice of mounting arrangements, voltage and frequency code (see ordering information page).

I_s / I_N = Starting current
T_I / T_N = Locked rotor torque
T_b / T_N = Breakdown torque

Efficiency values are given according to IEC 60034-2-1; 2007.

Process performance cast iron motors

Technical data for totally enclosed squirrel cage three phase motors

IP 55 – IC 411 – Insulation class F, temperature rise class B

Output kW	Motor type	Product code	Speed r/min	Efficiency IEC 60034-2-1; 2007			Power factor cos φ	Current		Torque			Moment of inertia J = 1/4 GD ² kgm ²	Weight kg	Sound pressure level L _{PA} dB
				Full load 100%	3/4 load 75%	1/2 load 50%		I _N A	I _s / I _N	T _N Nm	T _I / T _N	T _b / T _N			
750 r/min = 8-poles			400 V 50 Hz			CENELEC-design									
0.55	M3BP 90 SLC	3GBP 094 103-••B	655	61.8	65.6	65.2	0.67	1.91	2.3	8	1.3	1.53	0.00491	25	53
0.75	M3BP 100 LA	3GBP 104 101-••B	710	74	73	68.2	0.61	2.3	3.6	10	1.8	2.5	0.0072	30	46
1.1	M3BP 100 LB	3GBP 104 102-••B	695	76	76.5	74.6	0.66	3.1	3.4	15.1	1.7	2.2	0.00871	30	53
1.5	M3BP 112 M	3GBP 114 101-••B	690	74.4	75.9	74.1	0.7	4.1	3.2	20.7	1.4	1.87	0.0106	39	55
2.2	M3BP 132 SMA	3GBP 134 101-••B	715	79.7	80.8	78.7	0.66	6	3.2	29.3	1.1	1.7	0.03336	70	56
3	M3BP 132 SMB	3GBP 134 102-••B	715	79.9	80.8	79.1	0.64	8.4	3.2	40	1.2	1.8	0.04003	75	58
4	M3BP 160 MLA	3GBP 164 031-••G	728	84.1	85.1	83.7	0.67	10.2	5.4	52.4	1.5	2.6	0.068	120	59
5.5	M3BP 160 MLB	3GBP 164 032-••G	726	84.7	86	84.9	0.67	13.9	5.6	72.3	1.4	2.6	0.085	134	59
7.5	M3BP 160 MLC	3GBP 164 033-••G	727	86.1	87.3	86.6	0.65	19.3	4.7	98.5	1.5	2.8	0.132	184	59
11	M3BP 180 MLA	3GBP 184 031-••G	731	86.8	88.4	87.8	0.67	27.3	4.4	143	1.8	2.6	0.214	233	59
15	M3BP 200 MLA	3GBP 204 031-••G	737	90.2	91.3	90.9	0.74	32.4	5.3	194	2	2.4	0.45	290	60
18.5	M3BP 225 SMA	3GBP 224 031-••G	739	91	92	91.5	0.73	40.1	5.2	239	2	2.3	0.669	350	63
22	M3BP 225 SMB	3GBP 224 032-••G	738	91.6	92.4	92	0.74	46.8	5.5	284	2	2.3	0.722	363	63
30	M3BP 250 SMA	3GBP 254 031-••G	742	92.4	92.9	92.3	0.71	66	5.8	386	2.6	2.4	1.404	440	63
37	M3BP 280 SMA	3GBP 284 210-••G	741	92.7	92.7	91.6	0.78	73.8	7.3	476	1.7	3	1.85	605	65
45	M3BP 280 SMB	3GBP 284 220-••G	741	93.2	93.2	92.2	0.78	89.3	7.6	579	1.8	3.1	2.2	645	65
55	M3BP 315 SMA	3GBP 314 210-••G	742	93.4	93.5	92.7	0.81	104	7.1	707	1.6	2.7	3.2	830	62
75	M3BP 315 SMB	3GBP 314 220-••G	741	93.7	93.9	93.4	0.82	140	7.1	966	1.7	2.7	4.1	930	62
90	M3BP 315 SMC	3GBP 314 230-••G	741	94	94.2	93.6	0.82	168	7.4	1159	1.8	2.7	4.9	1000	64
110	M3BP 315 MLA	3GBP 314 410-••G	740	94	94.3	94	0.83	203	7.3	1419	1.8	2.7	5.8	1150	72
132	M3BP 355 SMA	3GBP 354 210-••G	744	94.7	94.7	94	0.8	251	7.5	1694	1.5	2.6	7.9	1520	69
160	M3BP 355 SMB	3GBP 354 220-••G	744	95.2	95.2	94.5	0.8	303	7.6	2053	1.6	2.6	9.7	1680	69
200	M3BP 355 SMC	3GBP 354 230-••G	743	95.3	95.4	94.8	0.8	378	7.4	2570	1.6	2.6	11.3	1820	69
250	M3BP 355 MLB	3GBP 354 420-••G	743	95.4	95.5	95	0.8	472	7.5	3213	1.6	2.7	13.5	2180	72
315 ¹⁾	M3BP 355 LKB	3GBP 354 820-••G	742	95.5	95.6	95	0.8	595	7.9	4053	1.7	2.7	16.5	2600	75
315	M3BP 400 LA	3GBP 404 510-••G	744	96.1	96.2	95.8	0.81	584	7	4043	1.2	2.6	17	2900	71
315	M3BP 400 LKA	3GBP 404 810-••G	744	96.1	96.2	95.8	0.81	584	7	4043	1.2	2.6	17	2900	71
355	M3BP 400 LB	3GBP 404 520-••G	743	96.2	96.3	96.1	0.83	641	6.8	4562	1.2	2.5	21	3200	71
355	M3BP 400 LKB	3GBP 404 820-••G	743	96.2	96.3	96.1	0.83	641	6.8	4562	1.2	2.5	21	3200	71
400	M3BP 400 LC	3GBP 404 530-••G	744	96.3	96.4	96	0.82	731	7.4	5134	1.3	2.7	24	3400	71
400	M3BP 400 LKC	3GBP 404 830-••G	744	96.3	96.4	96	0.82	731	7.4	5134	1.3	2.7	24	3400	71
450	M3BP 450 LA	3GBP 454 510-••G	744	96.2	96.4	96.2	0.83	813	6	5775	1	2.5	26	3750	80
500	M3BP 450 LB	3GBP 454 520-••G	744	96.3	96.4	96.2	0.83	902	6.4	6417	1	2.6	29	4000	80
560	M3BP 450 LC	3GBP 454 530-••G	744	96.4	96.5	96.1	0.82	1022	7	7187	1.2	2.9	35	4350	80
630 ¹⁾	M3BP 450 LD	3GBP 454 540-••G	745	96.6	96.6	96.2	0.81	1162	7.6	8075	1.3	3.2	41	4800	80
400	M3BP 400 LKC	3GBP 404 830-••G	744	96.3	96.4	96.0	0.82	731	7.4	5134	1.3	2.7	24	3400	71
450	M3BP 450 LA	3GBP 454 510-••G	744	96.2	96.4	96.2	0.83	813	6.0	5775	1.0	2.5	26	3750	80
500	M3BP 450 LB	3GBP 454 520-••G	744	96.3	96.4	96.2	0.83	902	6.4	6417	1	2.6	29	4000	80
560	M3BP 450 LC	3GBP 454 530-••G	744	96.4	96.5	96.1	0.82	1022	7.0	7187	1.2	2.9	35	4350	80
630 ¹⁾	M3BP 450 LD	3GBP 454 540-••G	745	96.6	96.6	96.2	0.81	1162	7.6	8075	1.3	3.2	41	4800	80
750 r/min = 8-poles			400 V 50 Hz			CENELEC-design									
55	M3BP 280 SMC	3GBP 284 230-••G	741	93.4	93.5	92.8	0.8	106	7.9	708	1.9	3.1	2.85	725	65
132	M3BP 315 LKA	3GBP 314 810-••G	740	94.1	94.4	94.2	0.83	243	7.3	1703	1.8	2.6	7.3	1410	74
150	M3BP 315 LKB	3GBP 314 820-••G	741	94.3	94.6	94.3	0.83	276	7.7	1933	1.9	2.7	8.3	1520	74
160	M3BP 315 LKC	3GBP 314 830-••G	740	94.2	94.6	94.3	0.83	295	7.7	2064	1.9	2.8	9.2	1600	75

¹⁾ Temperature rise class F

The two bullets in the product code indicate choice of mounting arrangements, voltage and frequency code (see ordering information page).

I_s / I_N = Starting current
T_I / T_N = Locked rotor torque
T_b / T_N = Breakdown torque

Efficiency values are given according to IEC 60034-2-1; 2007.

Process performance cast iron motors

Technical data for totally enclosed squirrel cage three phase motors

IP 55 – IC 411 – Insulation class F, temperature rise class B

Output kW	Motor type	Product code	Speed r/min	Efficiency IEC 60034-2-1; 2007			Power factor cos φ	Current		Torque			Moment of inertia J = 1/4 GD ² kgm ²	Weight kg	Sound pressure level L _{PA} dB
				Full load 100%	3/4 load 75%	1/2 load 50%		I _N A	I _s /I _N	T _N Nm	T _I /T _N	T _b /T _N			
600 r/min = 10-poles			400 V 50 Hz			GENELEC-design									
37	M3BP 280 SMB	3GBP 285 220-••G	593	92,5	92,3	90,9	0,73	79	6,6	595	1,6	3	2,2	645	60
45	M3BP 280 SMC	3GBP 285 230-••G	592	93	92,9	91,7	0,75	93,1	6,7	725	1,6	2,8	2,85	725	60
55	M3BP 315 SMB	3GBP 315 220-••G	594	93,8	93,8	92,9	0,78	108	6,7	884	1,6	2,7	4,1	930	70
75	M3BP 315 SMC	3GBP 315 230-••G	593	93,6	93,7	92,8	0,78	148	6,6	1207	1,5	2,8	4,9	1000	70
90	M3BP 315 MLA	3GBP 315 410-••G	593	93,7	93,8	93	0,78	177	6,6	1449	1,7	2,7	5,8	1150	70
110	M3BP 355 SMA	3GBP 355 210-••G	595	94,5	94,5	93,6	0,76	221	6,6	1765	1,3	2,5	7,9	1520	73
132	M3BP 355 SMB	3GBP 355 220-••G	594	94,8	94,9	94,2	0,79	254	6,6	2122	1,3	2,4	9,7	1680	73
160	M3BP 355 SMC	3GBP 355 230-••G	594	94,8	94,9	94,2	0,77	316	6,9	2572	1,4	2,5	11,3	1820	76
200	M3BP 355 MLB	3GBP 355 420-••G	594	95	95,1	94,5	0,78	389	6,5	3215	1,4	2,4	13,5	2180	77
250 ¹⁾	M3BP 355 LKB	3GBP 355 820-••G	593	95,1	95,3	94,8	0,78	486	6,3	4025	1,4	2,3	16,5	2600	79
250	M3BP 400 LB	3GBP 405 520-••G	595	95,3	95,3	94,5	0,74	511	6,2	4012	1,3	2,3	20	3100	79
250	M3BP 400 LKB	3GBP 405 820-••G	595	95,3	95,3	94,5	0,74	511	6,2	4012	1,3	2,3	20	3100	79
315	M3BP 400 LC	3GBP 405 530-••G	595	95,4	95,4	94,7	0,74	644	6,2	5055	1,3	2,3	24	3400	79
315	M3BP 400 LKC	3GBP 405 830-••G	595	95,4	95,4	94,7	0,74	644	6,2	5055	1,3	2,3	24	3400	79
355	M3BP 450 LA	3GBP 455 510-••G	596	95,9	95,9	95,2	0,72	742	5,8	5687	1,1	2,2	31	4050	82
400	M3BP 450 LB	3GBP 455 520-••G	596	95,9	95,9	95,1	0,72	836	5,7	6408	1	2,1	34	4250	82
450	M3BP 450 LC	3GBP 455 530-••G	596	96,1	96,1	95,4	0,73	925	5,8	7210	1	2,1	38	4550	82
500 ¹⁾	M3BP 450 LD	3GBP 455 540-••G	596	96,1	96,1	95,4	0,71	1057	5,9	8011	1,1	2,2	42	4800	82
500 r/min = 12-poles			400 V 50 Hz			GENELEC-design									
30	M3BP 280 SMB	3GBP 286 220-••G	493	90,2	89,5	86,9	0,59	81,3	5,8	581	1,9	3	2,2	645	71
37	M3BP 280 SMC	3GBP 286 230-••G	493	90,6	89,8	87,2	0,58	101	6,3	716	2	3,2	2,85	725	71
45	M3BP 315 SMB	3GBP 316 220-••G	494	92,8	92,9	92	0,76	92	6,5	869	1,6	2,6	4,1	930	71
55	M3BP 315 SMC	3GBP 316 230-••G	493	93	93,2	92,4	0,77	110	6,5	1065	1,6	2,6	4,9	1000	71
75	M3BP 315 MLA	3GBP 316 410-••G	493	93,2	93,4	92,8	0,76	152	6,3	1452	1,5	2,5	5,8	1150	71
90	M3BP 355 SMA	3GBP 356 210-••G	495	93,5	93,5	92,5	0,72	192	5,7	1736	1,3	2,4	7,9	1520	75
110	M3BP 355 SMB	3GBP 356 220-••G	495	93,8	93,8	92,7	0,71	238	6	2122	1,4	2,5	9,7	1680	75
132	M3BP 355 SMC	3GBP 356 230-••G	495	93,9	93,9	92,9	0,71	285	6	2546	1,4	2,5	11,3	1820	77
160	M3BP 355 MLB	3GBP 356 420-••G	494	93,8	94	93,3	0,74	332	5,7	3092	1,3	2,4	13,5	2180	77
200 ¹⁾	M3BP 355 LKB	3GBP 356 820-••G	494	93,9	94,1	93,4	0,73	421	5,8	3866	1,4	2,4	16,5	2600	79
200	M3BP 400 LB	3GBP 406 520-••G	495	95	95	94,3	0,79	384	5,4	3858	1,1	2,2	20	3100	82
200	M3BP 400 LKB	3GBP 406 820-••G	495	95	95	94,3	0,79	384	5,4	3858	1,1	2,2	20	3100	82
250	M3BP 400 LC	3GBP 406 530-••G	495	95,2	95,2	94,5	0,79	479	5,7	4822	1,1	2,2	24	3400	82
250	M3BP 400 LKC	3GBP 406 830-••G	495	95,2	95,2	94,5	0,79	479	5,7	4822	1,1	2,2	24	3400	82
315	M3BP 450 LB	3GBP 456 520-••G	496	95,6	95,6	94,8	0,76	625	5,5	6064	1	2,1	34	4300	82
355	M3BP 450 LC	3GBP 456 530-••G	495	95,6	95,6	95	0,76	705	5,3	6848	1	2	38	4550	82
400 ¹⁾	M3BP 450 LD	3GBP 456 540-••G	495	95,7	95,8	95,2	0,77	783	5,3	7716	1	2	42	4800	82

¹⁾ Temperature rise class F

The two bullets in the product code indicate choice of mounting arrangements, voltage and frequency code (see ordering information page).

I_s / I_N = Starting current
T_I / T_N = Locked rotor torque
T_b / T_N = Breakdown torque

Efficiency values are given according to IEC 60034-2-1; 2007.



Sound technical details

Fan-Type: **VR 56 S10 E0 S K 2500**

Volume flow 390000,0 m³/h
 108,3 m³/s
 Total pressure rise 8700 Pa
 Operating density 0,836 kg/m³
 Rotational speed 1200 1/min
 Number of blades 10
 Circular frequency 200 Hz
 Max. temperature 150 °C
 Diameter cooling disc 500 mm

The levels apply to a 350 mm isolation, 1 mm St

Octavo-level (A-evaluated) [dB]								
fm [Hz]	LwA	LwA(K)D	LwA(K)S	LwA(U)	LwA(Kü)	LwA(U)o	LpA	LpA(S)
63	101	98	97	79	59	79	60	84
125	109	107	105	86	72	86	67	92
250	118	117	113	92	80	92	73	100
500	118	116	112	91	86	90	72	99
1000	117	115	111	90	87	86	71	98
2000	112	111	107	86	84	81	67	94
4000	106	105	101	80	78	74	61	88
8000	97	96	92	70	69	64	51	80
Sum	123	122	118	97	91	96	78	105

- LwA = Sound power level
- LwA(K)D = Sound power level - outlet
- LwA(K)S = Sound power level - inlet
- LwA(U) = Sound power level outside the fan
- LwA(Kü) = Sound power level of the cooling disc
- LwA(U)o = Sound power level without cooling disc
- LpA = 1m sound pressure level outside the fan, according DIN 45635
- LpA(S) = Sound pressure level with 1m/45° desist from open suction inlet

The sound technical data accord with VDI 3731 and are measured according to DIN 45635, in-duct or enveloping surface method.

The measuring surface sound pressure level LA is only valid, when the sound of the connected ductwork is at least 8 dB under the mentioned level of the fan.

The soundpressure data are only valid for open air space.

Sound of motors, bearings and belt-drives are not taken into consideration.

The tolerance of the mentioned levels is according to DIN 24166, Toleranceclass 2.

Air Shock @ 3ft

Instrument:		2260
Application:		BZ7202 version 2.0
Start Time:		08/08/2013 08:42:20
End Time:		08/08/2013 08:42:29
Elapsed Time:		0:00:09
Bandwidth:		1/3 Octave
Peaks Over:		140.0 dB
Range:		29.8-109.8 dB

	Time	Frequency
Broad-band measurements:	S F I	A L
Broad-band statistics:	F	A
Octave measurements:	F	L
Instrument Serial Number:		2248356
Microphone Serial Number:		2458291
Input:		Microphone
Pol. Voltage:		0 V
S. I. Correction:		Frontal

Calibration Time:		08/08/2013 08:10:02
Calibration Level:		94.0 dB
Sensitivity:		-25.9 dB
ZF0023:		Not used

Air Shock @ 3ft

	Start time	End time	Elapsed time	Overload [%]	LAeq [dB]	LAFmax [dB]	LAFmin [dB]	LAF10 [dB]	LAF90 [dB]
Value				0.09	85.5	100.8	68.2	89.3	69.2
Time	08:42:20	08:42:29	0:00:09						
Date	08/08/2013	08/08/2013							

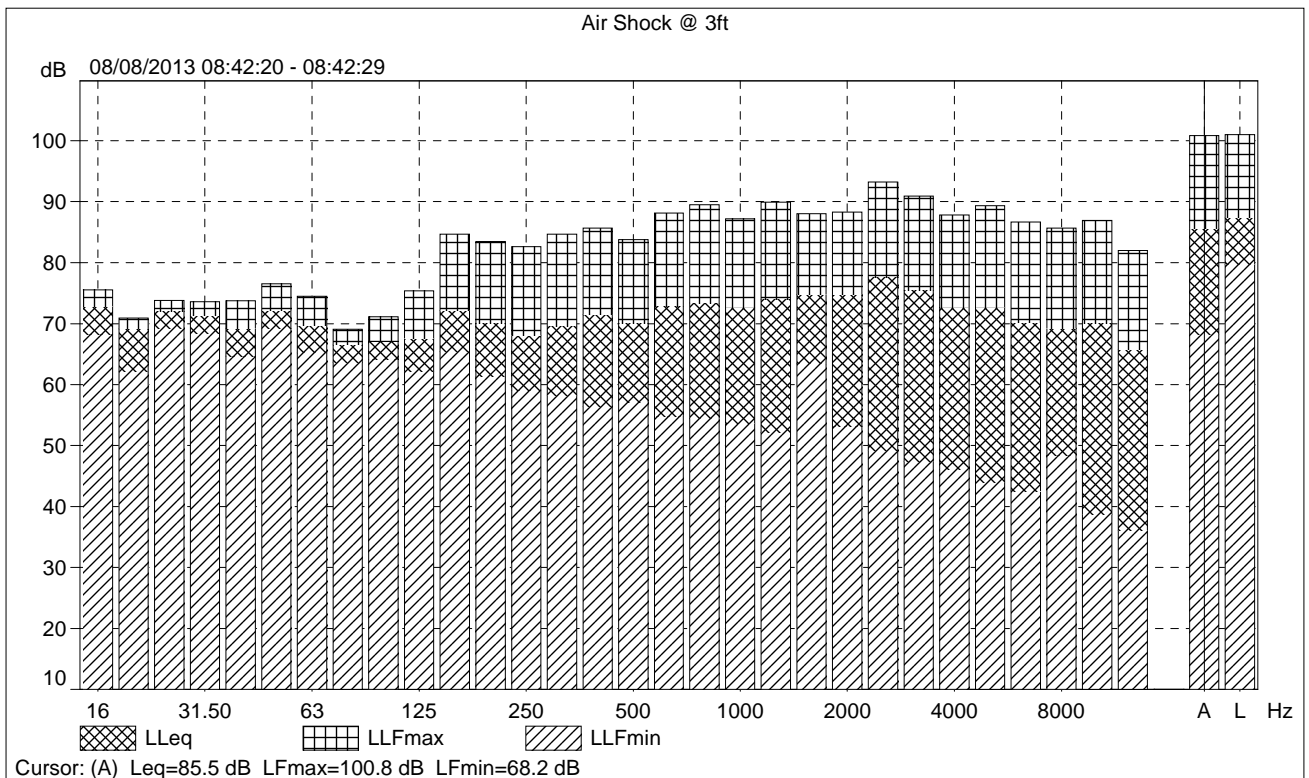

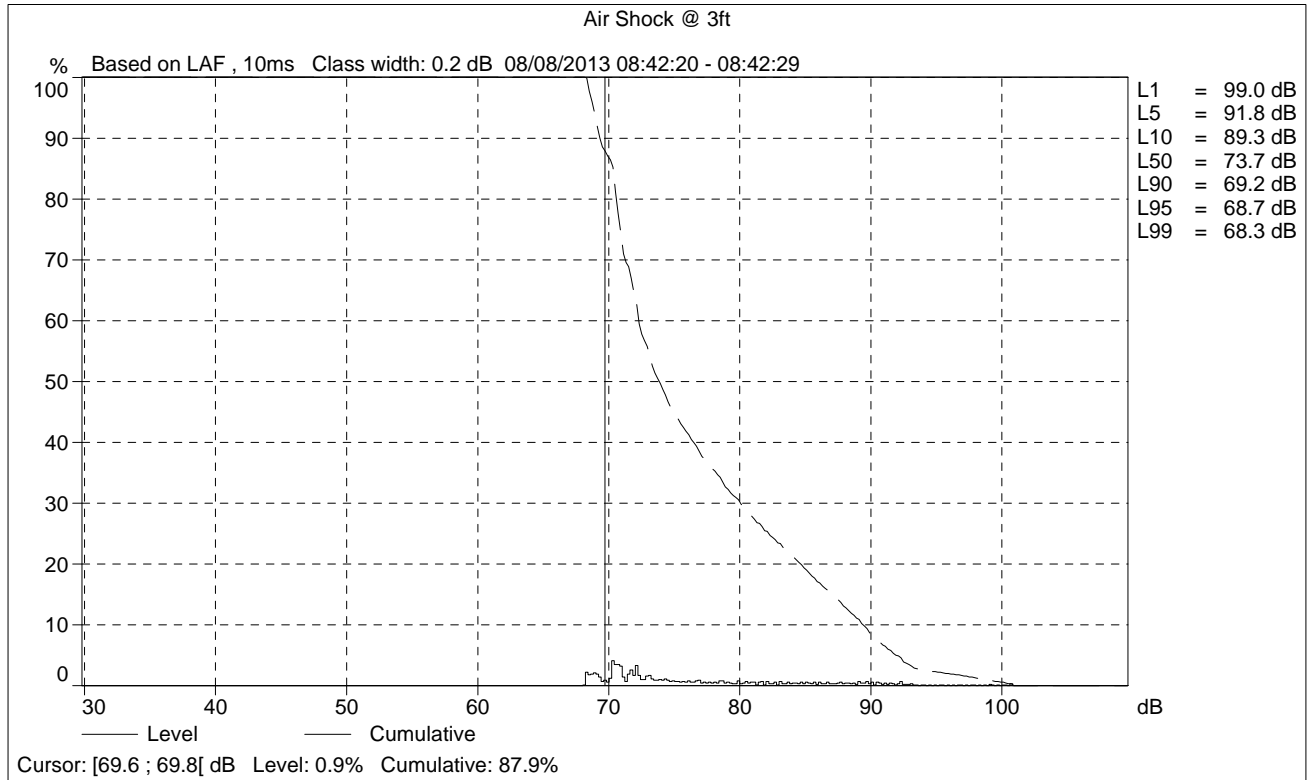

2260

Instrument:		2260
Application:		BZ7202 version 2.0
Start Time:		08/08/2013 09:20:25
End Time:		08/08/2013 09:20:56
Elapsed Time:		0:00:31
Bandwidth:		1/3 Octave
Peaks Over:		140.0 dB
Range:		29.8-109.8 dB

	Time	Frequency
Broad-band measurements:	S F I	A L
Broad-band statistics:	F	A
Octave measurements:	F	L
Instrument Serial Number:		2248356
Microphone Serial Number:		2458291
Input:		Microphone
Pol. Voltage:		0 V
S. I. Correction:		Frontal

Calibration Time:		08/08/2013 08:10:02
Calibration Level:		94.0 dB
Sensitivity:		-25.9 dB
ZF0023:		Not used

Hot Gas Generator

	Start time	End time	Elapsed time	Overload [%]	L _{Aeq} [dB]	L _{AFmax} [dB]	L _{AFmin} [dB]	L _{AF10} [dB]	L _{AF90} [dB]
Value				0.00	92.0	93.0	91.1	92.4	91.6
Time	09:20:25	09:20:56	0:00:31						
Date	08/08/2013	08/08/2013							

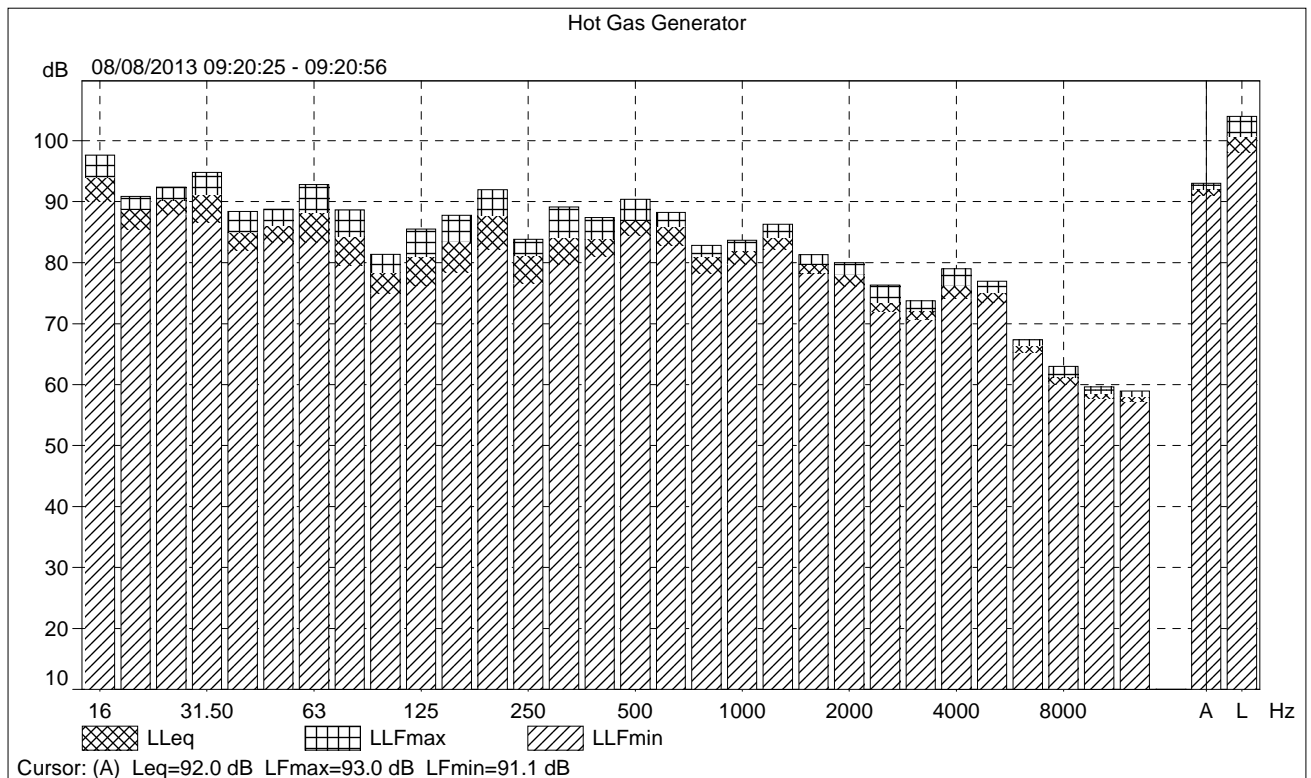

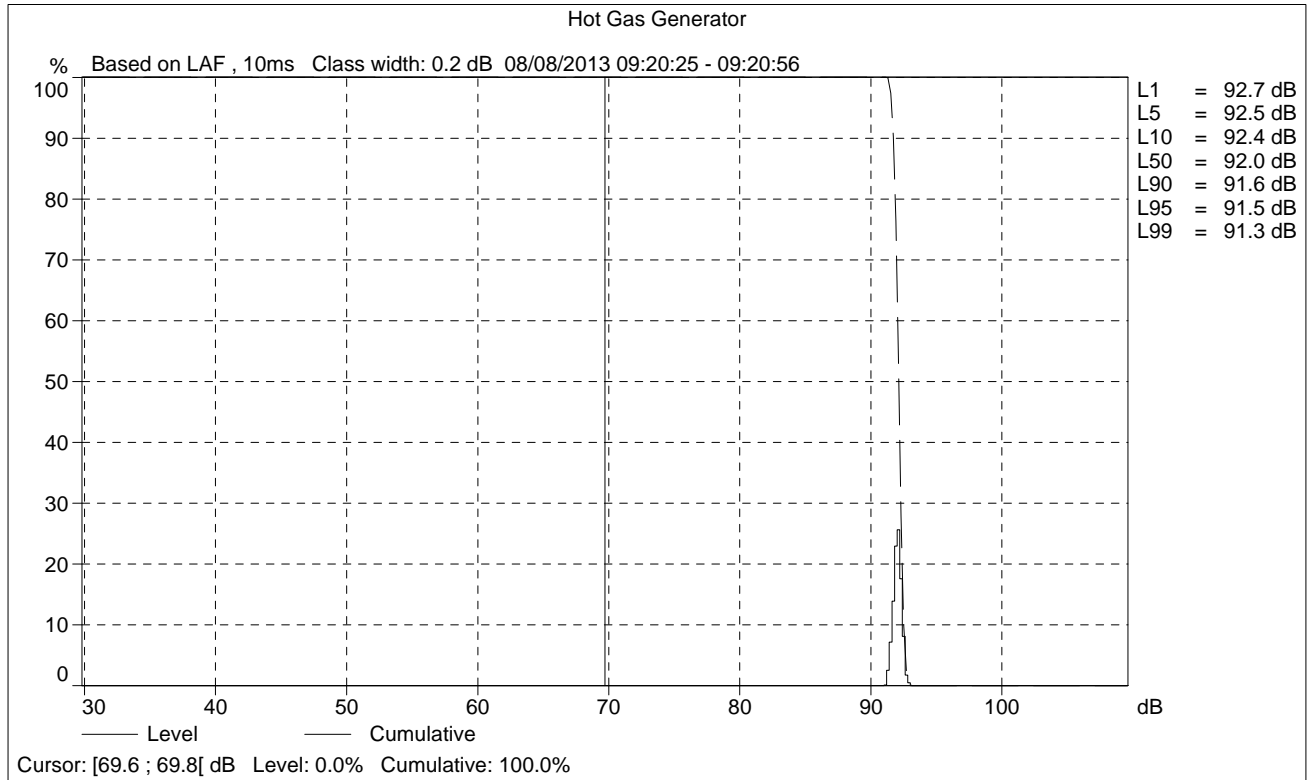

M E S S B E R I C H T N R. 128C8 M1

**Messtechnische Bestimmung der Schalleistungspegel
verschiedener Anlagenteile der Rohmühle LM 46.2+2 der
Firma Loesche GmbH am Standort Esch-sur-Alzette (Luxemburg),
Firma Cimalux**

**Messtechnische Bestimmung der Schalleistungspegel verschiedener
Anlagenteile der Rohmühle LM 46.2+2
der Firma Loesche GmbH
am Standort Esch-sur-Alzette (Luxemburg), Firma Cimalux**

Auftraggeber:
Loesche GmbH
Hansaallee 243
40549 Düsseldorf

Werner Genest und Partner
Ingenieurgesellschaft mbH
Messstelle §§ 26, 28 BImSchG
Güteprüfstelle gemäß DIN 4109

Parkstraße 70, 67061 Ludwigshafen/Rhein
Telefon: 0621 / 586150 - Telefax: 0621 / 582354
E-Mail: info@genest.de

Büro Berlin
Marktstraße 8
10317 Berlin
Telefon: 030 / 29490949
Telefax: 030 / 29490948
E-Mail: berlin@genest.de

Büro Dresden
Alträcknitz 8
01217 Dresden
Telefon: 0351 / 4764150
Telefax: 0351 / 4764130
E-Mail: genest.dresden@t-online.de

	<u>Seite:</u>
1. AUFGABENSTELLUNG	1
2. ALLGEMEINE ANGABEN	1
3. DURCHFÜHRUNG DER MESSUNGEN	3
4. MESSERGEBNISSE	3
5. QUALITÄT DER ERGEBNISSE	5

1. AUFGABENSTELLUNG

Die Firma Loesche GmbH stellt verschiedene Mühlen unter anderem für die Zementindustrie her. Für interne Zwecke sowie als Information für potenzielle Kunden sollte am Standort Esch-sur-Alzette (Luxemburg) auf dem Firmengelände der Firma Cimalux (Zementindustrie) die Rohmühle LM 46.2+2 schalltechnisch vermessen werden.

Für die in diesem Messbericht dokumentierte Untersuchung sollten aufgrund der Fremdgeräuschpegel Schallintensitätspegelmessungen gemäß DIN ISO 9614, Teil 2 an den einzelnen Anlagenteilen der Mühle zur Bestimmung der Schalleistungspegel durchgeführt werden. Darüber hinaus sollten Schalldruckpegelmessungen an verschiedenen Messpunkten an der Mühle durchgeführt werden.

2. ALLGEMEINE ANGABEN

- **Messtermin**

Die Messungen wurden am 06.05.2011 in der Zeit zwischen 09:00 und 13:00 Uhr durchgeführt.

- **Betriebszustand**

Die Mühle wurde gemäß dem Anlagenbetreiber während der Messungen in einem repräsentativen Betriebszustand gefahren.

- **Messgeräte**

Tabelle 1: Messgeräte

Gerät	Fabrikat	Typ	Serien-Nr.
Schallintensitäts-System inkl. Intensitätssonde, bestehend aus Modul-Schallpegel-Analysator 2260E, Investigator mit BZ7210 und Schallintensitäts-Betriebssoftware BZ7205	Brüel & Kjaer	2260	2554039
	Brüel & Kjaer	2683	2571422
Schallintensitätskalibrator	Brüel & Kjaer	4297	2584991
Schallanalysator	NORSONIC	140	1403376
Mikrofon	NORSONIC	140-1225	103253
Vorverstärker	NORSONIC	140-1209	13069
Kalibrator	NORSONIC	1251	32161

Der verwendete Schallpegelanalysator NORSONIC, Typ 140 ist ein Präzisionsschallpegelmessgerät nach DIN EN 61672-1 und besitzt das gültige Eichsiegel des Landesbetriebes Mess- und Eichwesen Nordrhein-Westfalen in Dortmund. Die Messeinrichtung wurde vor und nach den Messungen mittels eines Kalibrators auf einwandfreie Funktion überprüft.

Die Abweichung der registrierten Kalibriersignale betrug hierbei maximal 0,2 dB und liegt somit innerhalb der Messgerätetoleranz für Messgeräte der Genauigkeitsklasse 1.

Das verwendete Schallintensitäts-Messsystem der Firma Brüel & Kjaer, Typ 2260 wurde in Verbindung mit der Schallintensitäts-Messsonde mittels eines Kalibrators auf einwandfreie Funktion überprüft.

3. DURCHFÜHRUNG DER MESSUNGEN

Die Schallintensitätspegelmessungen an den verschiedenen Anlagenteilen wurden in Anlehnung an die DIN EN ISO 9614, Teil 2 „Bestimmung der Schalleistungspegel von Geräuschquellen aus Schallintensitätsmessungen, Teil 2: Messungen mit kontinuierlicher Abtastung“ durchgeführt.

Neben den Schallmessungen zur Bestimmung der Schalleistungspegel der einzelnen Anlagenteile sollte gemäß Auftraggeber der Schalldruckpegel an verschiedenen Messpunkten an der Mühle messtechnisch erfasst und dargestellt werden.

Die Ermittlung der Schalleistungspegel mit den für die Berechnung notwendigen Messflächen der einzelnen Anlagenteile ist in den Anlagen 1 bis 8 dargestellt.

4. MESSERGEBNISSE

Bei der Betrachtung der Messergebnisse war festzustellen, dass bei verschiedenen Anlagenteilen eine Auswertung nach DIN EN ISO 9614, Teil 2 in einzelnen Oktaven aufgrund der Fremdgeräuschsituation nicht möglich war. Für diese Oktaven wurden zur oberen Abschätzung die Schallintensitätspegel wie folgt festgelegt:

- Schallintensitätspegel = Schalldruckpegel – 10 dB

An dem Anlagenteil „Getriebschmierstation“ waren Schallintensitätspegelmessungen aufgrund der hohen Fremdgeräusche für sämtliche Oktaven nicht auswertbar. Es wurde daher auf die Auswertung der Messungen für dieses Anlagenteil verzichtet.

In der nachfolgenden Tabelle sind die ermittelten Schalleistungspegel als Ganzzahlwert (gerundet) dargestellt:

Tabelle 2: Schalleistungspegel

Bezeichnung der Anlagenteile	Schalleistungspegel L_{WA} in dB(A)	Messberichts- Anlagen-Nr.
Antrieb Reject Becherwerk	99	1
Reject-Abwurf	107	2
Zellradschleuse mit Klinkersand	96	3
Zellradschleuse mit Hüttensand	91	4
Mühlenbühne	102	5
Mühlengetriebe	108	6
Motor Mühlenantrieb	101	7
Mühlenventilator	92	8

Darüber hinaus sollten die Schalldruckpegel von zwei Anlagenteilen in einem definierten Abstand ermittelt werden. Aufgrund der hohen Fremdgeräusche in der Halle konnte zur Beschreibung des Anlagenteils lediglich der Schallintensitätspegel messtechnisch erfasst werden. Dieser entspricht unter Freifeldbedingungen dem Schalldruckpegel.

- Mühlenbühne, 1 m Abstand zur Anlage: $L_I = L_{pA(\text{Anlagenteil})} = 82,0 \text{ dB(A)}$
- Mühlenantrieb, entlang des Mühlenfundamentes: $L_I = L_{pA(\text{Anlagenteil})} = 86,7 \text{ dB(A)}$
- Mittlerer Raumschalldruckpegel,
Mittelwert über sämtliche begehbare Bühnen: $L_{pA} = 89,0 \text{ dB(A)}$

(Abmessung der Halle: Länge = 18,1 m, Breite = 25,0 m, Höhe = 41,5 m, die Raumbegrenzungsflächen sind schallhart ausgeführt)

5. QUALITÄT DER ERGEBNISSE

Aufgrund der vorgefundenen schalltechnischen Randbedingungen innerhalb der Produktionshalle ist eine pauschale Aussage zu möglichen Standardabweichungen der Messergebnisse nicht möglich. Bei folgenden Anlagenteilen konnte gemäß Genauigkeitsklasse 2 der DIN EN ISO 9614, Teil 2 gemessen werden:

- Antrieb Reject-Becherwerk, Anlage 1
- Mühlengetriebe, Anlage 6
- Mühlenantrieb, Anlage 7

Bei diesen Anlagenteilen ist gemäß Norm mit einer Standardabweichung für den A-bewerteten Summenpegel von $\pm 1,5$ dB zu rechnen.

Die übrigen Messergebnisse entsprechen zumindest für die maßgeblichen Oktav-Mittenfrequenzen der Genauigkeitsklasse 3 der Norm. Für diese Messungen ist gemäß Norm mit einer Standardabweichung, bezogen auf den A-bewerteten Summenpegel von ± 4 dB zu rechnen.

Dieser Messbericht umfasst 5 Seiten und 8 Anlagen.

Genest und Partner
Ingenieurgesellschaft mbH

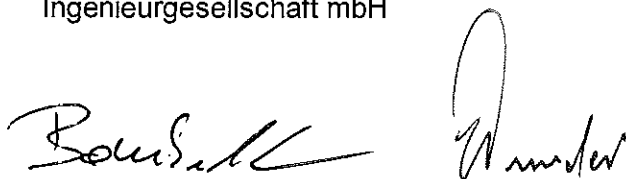

Ludwigshafen/Rhein, den 09.06.2011

Bombelka / Mi

Projekt:

Schalltechnische Vermessung der Rohmühle LM 46.2+2
der Firma Loesche GmbH

Auftraggeber:

Firma Loesche GmbH, Hansaallee 243, 40549 Düsseldorf

Schalleistungspegel Antrieb Reject - Becherwerk (+29 m)



Messfläche: Länge: 2,30 m Breite: 2,06 m Höhe: 2,20 m

Schalleistungspegel Antrieb Reject - Becherwerk (+29 m)

Messfläche (S) = 23,9 m²

Frequenz in Hz		A-bew. Oktavpegel in dB(A)									Summe
		32	63	125	250	500	1000	2000	4000	8000	dB(A)
Schallintensitätspegel	L _{IA}	42,9	60,3	74,2	75,5	75,9	77,0	79,5	80,7	66,9	85,6
Messflächenmaß	L _S	13,8	13,8	13,8	13,8	13,8	13,8	13,8	13,8	13,8	
Schalleistungspegel	L _{WA}	56,7	74,1	88,0	89,3	89,6	90,8	93,3	94,5	80,6	99,4

Messergebnis: Schalleistungspegel Antrieb Reject - Becherwerk (+29 m)

L_{WA} = 99 dB(A)

Bemerkung: Auswertung in Anlehnung an die Norm

Genest und Partner Ingenieurgesellschaft mbH

Parkstraße 70

67061 Ludwigshafen

Projekt:

**Schalltechnische Vermessung der Rohmühle LM 46.2+2
der Firma Loesche GmbH**

Auftraggeber:

Firma Loesche GmbH, Hansaallee 243, 40549 Düsseldorf

Schalleistungspegel Reject - Abwurf (+26 m)



Messfläche: Länge: 6,50 m Breite: 1,30 m Höhe: 1,60 m

Schalleistungspegel Reject - Abwurf (+26 m)

Messfläche (S) = 33,4 m²

Frequenz in Hz		A-bew. Oktavpegel in dB(A)									Summe dB(A)
		32	63	125	250	500	1000	2000	4000	8000	
Schallintensitätspegel	L _{IA}	43,2	53,5	68,2	71,6	75,2	84,4	87,8	87,3	79,0	91,9
Messflächenmaß	L _s	15,2	15,2	15,2	15,2	15,2	15,2	15,2	15,2	15,2	
Schalleistungspegel	L_{WA}	58,5	68,7	83,5	86,8	90,5	99,6	103,0	102,5	94,2	107,1

Messergebnis: Schalleistungspegel Reject - Abwurf (+26 m)

L_{WA} = 107 dB(A)

Bemerkung: Aufgrund der Fremdgeräuschsituation konnten die Pegel in den Oktaven 63 Hz bis 500 Hz nicht nach Norm ausgewertet werden (L_{pA} - L_{IA} > 10 dB). Die ausgewiesenen Pegel in diesen Oktaven sind als obere Abschätzung zu betrachten.

Genest und Partner Ingenieurgesellschaft mbH

Parkstraße 70

67061 Ludwigshafen

Projekt: Schalltechnische Vermessung der Rohmühle LM 46.2+2
der Firma Loesche GmbH

Auftraggeber: Firma Loesche GmbH, Hansaallee 243, 40549 Düsseldorf

Schalleistungspegel Zellradschleuse mit Klinkersand (+16,6 m)

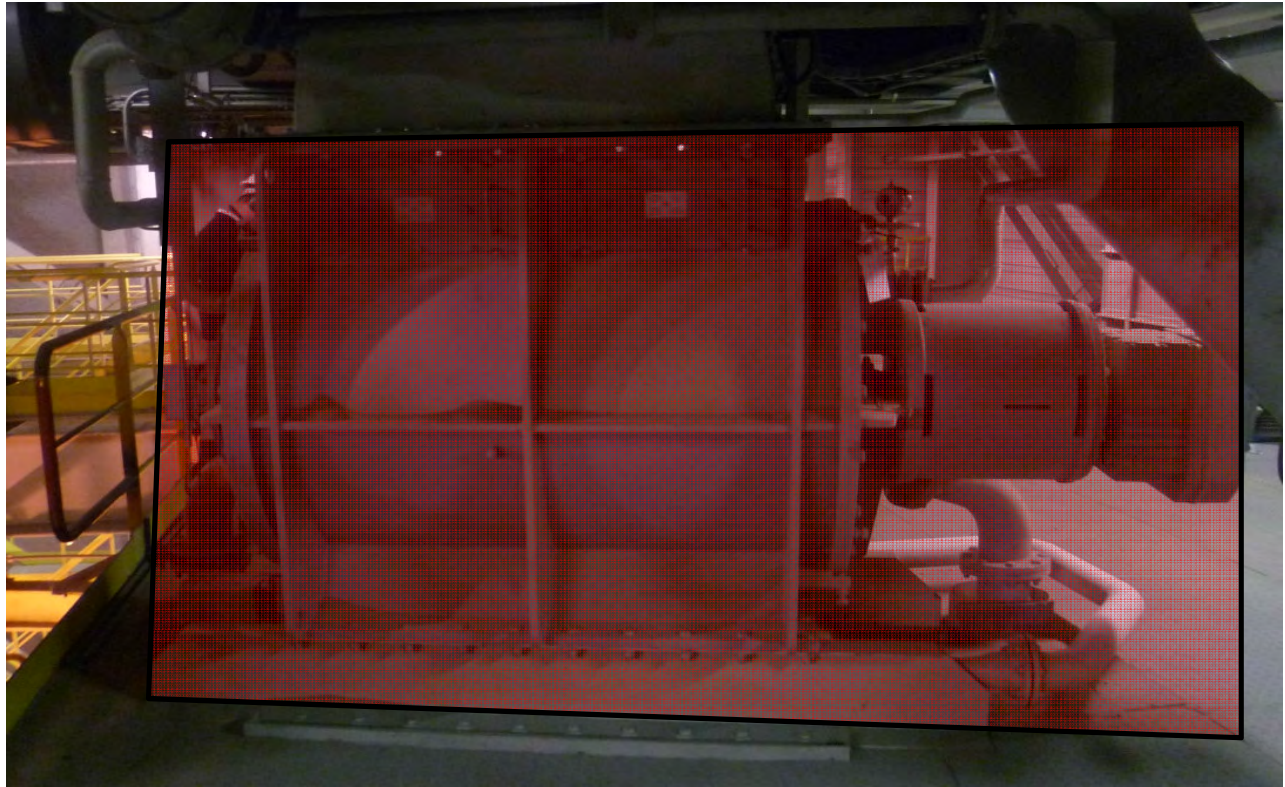

Messfläche: Länge: 3,70 m Breite: 1,40 m Höhe: 1,80 m

Schalleistungspegel Zellradschleuse mit Klinkersand (+16,6 m) Messfläche (S) = 18,4 m²

Frequenz in Hz		A-bew. Oktavpegel in dB(A)									Summe dB(A)
		32	63	125	250	500	1000	2000	4000	8000	
Schallintensitätspegel	L _{IA}	49,7	59,3	64,6	68,1	75,3	77,1	78,6	74,8	67,1	83,1
Messflächenmaß	L _S	12,6	12,6	12,6	12,6	12,6	12,6	12,6	12,6	12,6	
Schalleistungspegel	L_{WA}	62,3	72,0	77,2	80,8	88,0	89,8	91,3	87,5	79,8	95,7

Messergebnis: Schalleistungspegel Zellradschleuse mit Klinkersand (+16,6 m) L_{WA} = 96 dB(A)

Bemerkung: Aufgrund der Fremdgeräuschsituation konnten die Pegel in den Oktaven 250 Hz bis 500 Hz nicht nach Norm ausgewertet werden (L_{pA} - L_{IA} > 10 dB). Die ausgewiesenen Pegel in diesen Oktaven sind als obere Abschätzung zu betrachten.

Genest und Partner Ingenieurgesellschaft mbH Parkstraße 70 67061 Ludwigshafen

Projekt:

**Schalltechnische Vermessung der Rohmühle LM 46.2+2
der Firma Loesche GmbH**

Auftraggeber:

Firma Loesche GmbH, Hansaallee 243, 40549 Düsseldorf

Schalleistungspegel Zellradschleuse mit Hüttensand (+16,6 m)

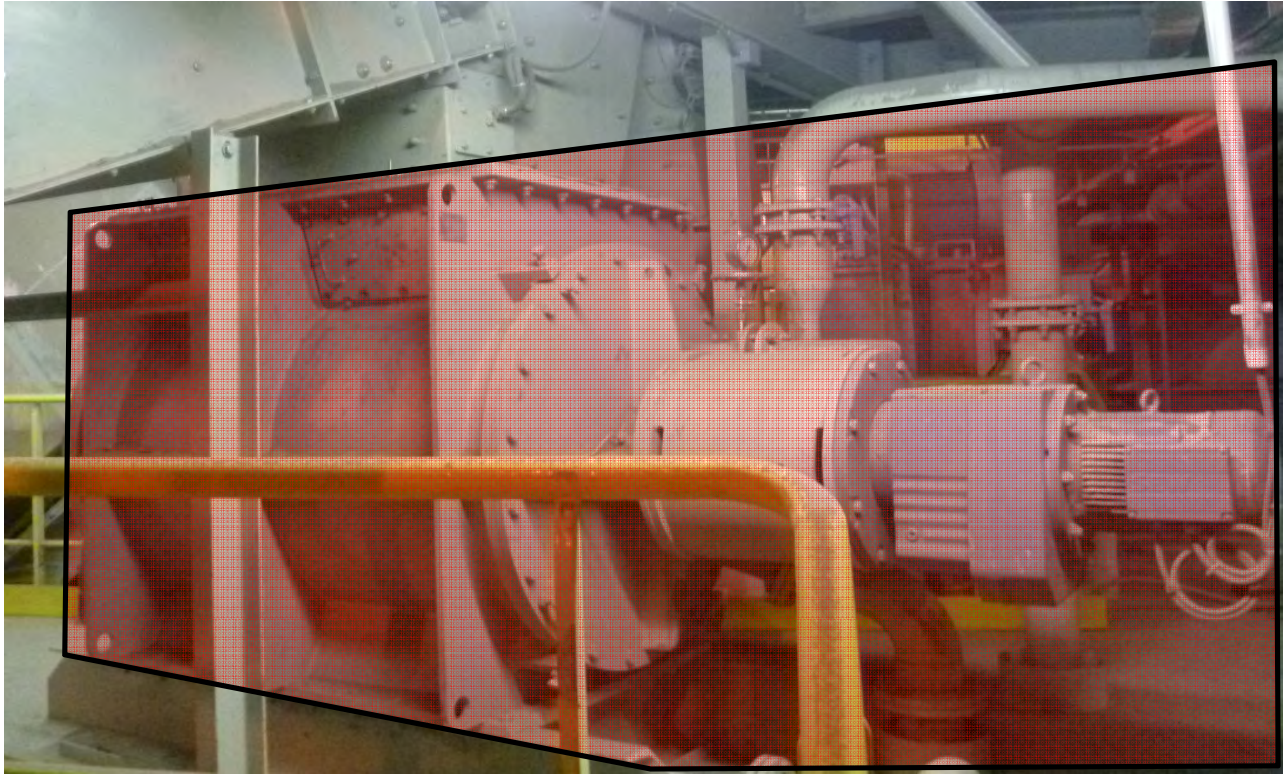

Messfläche: Länge: 3,70 m Breite: 1,40 m Höhe: 1,80 m

Schalleistungspegel Zellradschleuse mit Hüttensand (+16,6 m)

Messfläche (S) = 18,4 m²

Frequenz in Hz		A-bew. Oktavpegel in dB(A)									Summe dB(A)
		32	63	125	250	500	1000	2000	4000	8000	
Schallintensitätspegel	L _{IA}	48,5	60,1	62,6	65,0	73,8	71,4	72,4	67,7	65,2	78,5
Messflächenmaß	L _S	12,6	12,6	12,6	12,6	12,6	12,6	12,6	12,6	12,6	
Schalleistungspegel	L _{WA}	61,1	72,8	75,2	77,6	86,5	84,0	85,1	80,3	77,8	91,1

Messergebnis: Schalleistungspegel Zellradschleuse mit Hüttensand (+16,6 m) L_{WA} = 91 dB(A)

Bemerkung: Aufgrund der Fremdgeräuschsituation konnten die Pegel in den Oktaven 125 Hz bis 500 Hz nicht nach Norm ausgewertet werden (L_{pA} - L_{IA} > 10 dB). Die ausgewiesenen Pegel in diesen Oktaven sind als obere Abschätzung zu betrachten.

Genest und Partner Ingenieurgesellschaft mbH

Parkstraße 70

67061 Ludwigshafen

Projekt:

**Schalltechnische Vermessung der Rohmühle LM 46.2+2
der Firma Loesche GmbH**

Auftraggeber:

Firma Loesche GmbH, Hansaallee 243, 40549 Düsseldorf

Schalleistungspegel Mühlenbühne (+6,1 m)



Durchmesser Mühle, Bühnenhöhe 6,1 m:
Messabstand

6,5 m
1 m

Höhe d. Teilstücks:

3,4 m

Schalleistungspegel Mühlenbühne (+6,1 m)

Messfläche (S) = 90,8 m²

Frequenz in Hz		A-bew. Oktavpegel in dB(A)									Summe dB(A)
		32	63	125	250	500	1000	2000	4000	8000	
Schallintensitätspegel	L _{IA}	51,6	66,9	64,8	68,6	78,6	73,8	73,6	72,8	64,2	81,9
Messflächenmaß	L _S	19,6	19,6	19,6	19,6	19,6	19,6	19,6	19,6	19,6	
Schalleistungspegel	L_{WA}	71,2	86,4	84,4	88,2	98,1	93,4	93,2	92,4	83,8	101,5

Messergebnis:

Schalleistungspegel Mühlenbühne (+6,1 m)

L_{WA} = 102 dB(A)

Bemerkung:

Aufgrund der Fremdgeräuschsituation konnten die Pegel in den Oktaven 500 Hz bis 1000 Hz nicht nach Norm ausgewertet werden (L_{pA} - L_{IA} > 10 dB). Die ausgewiesenen Pegel in diesen Oktaven sind als obere Abschätzung zu betrachten.

Genest und Partner Ingenieurgesellschaft mbH

Parkstraße 70

67061 Ludwigshafen

Projekt:

**Schalltechnische Vermessung der Rohmühle LM 46.2+2
der Firma Loesche GmbH**

Auftraggeber:

Firma Loesche GmbH, Hansaallee 243, 40549 Düsseldorf

Schalleistungspegel Mühlengetriebe

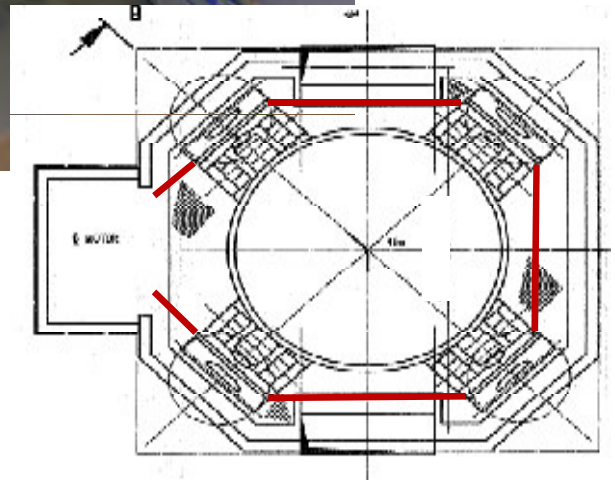
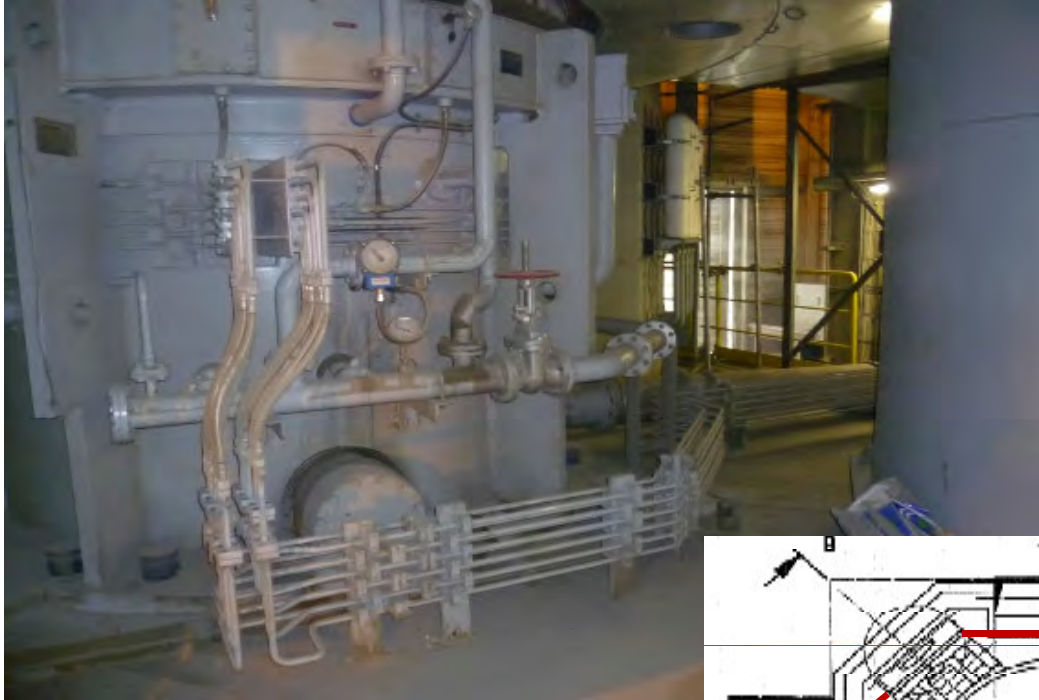

4 Öffnungsflächen im Mühlenaufbau zusammen: **51 m²**
(Gemessen zwischen den Trägern)

Schalleistungspegel Mühlengetriebe

Messfläche (S) = 51,0 m²

Frequenz in Hz		A-bew. Oktavpegel in dB(A)									Summe dB(A)
		32	63	125	250	500	1000	2000	4000	8000	
Schallintensitätspegel	L _{IA}	57,8	69,1	70,0	77,5	89,3	83,2	73,9	67,4	55,3	90,6
Messflächenmaß	L _S	17,1	17,1	17,1	17,1	17,1	17,1	17,1	17,1	17,1	
Schalleistungspegel	L_{WA}	74,9	86,2	87,1	94,5	106,3	100,3	91,0	84,5	72,4	107,7

Messergebnis: **Schalleistungspegel Mühlengetriebe**

L_{WA} = 108 dB(A)

Bemerkung: **Auswertung in Anlehnung an die Norm**

Projekt:

**Schalltechnische Vermessung der Rohmühle LM 46.2+2
der Firma Loesche GmbH**

Auftraggeber:

Firma Loesche GmbH, Hansaallee 243, 40549 Düsseldorf

Schalleistungspegel Motor, Mühlenantrieb

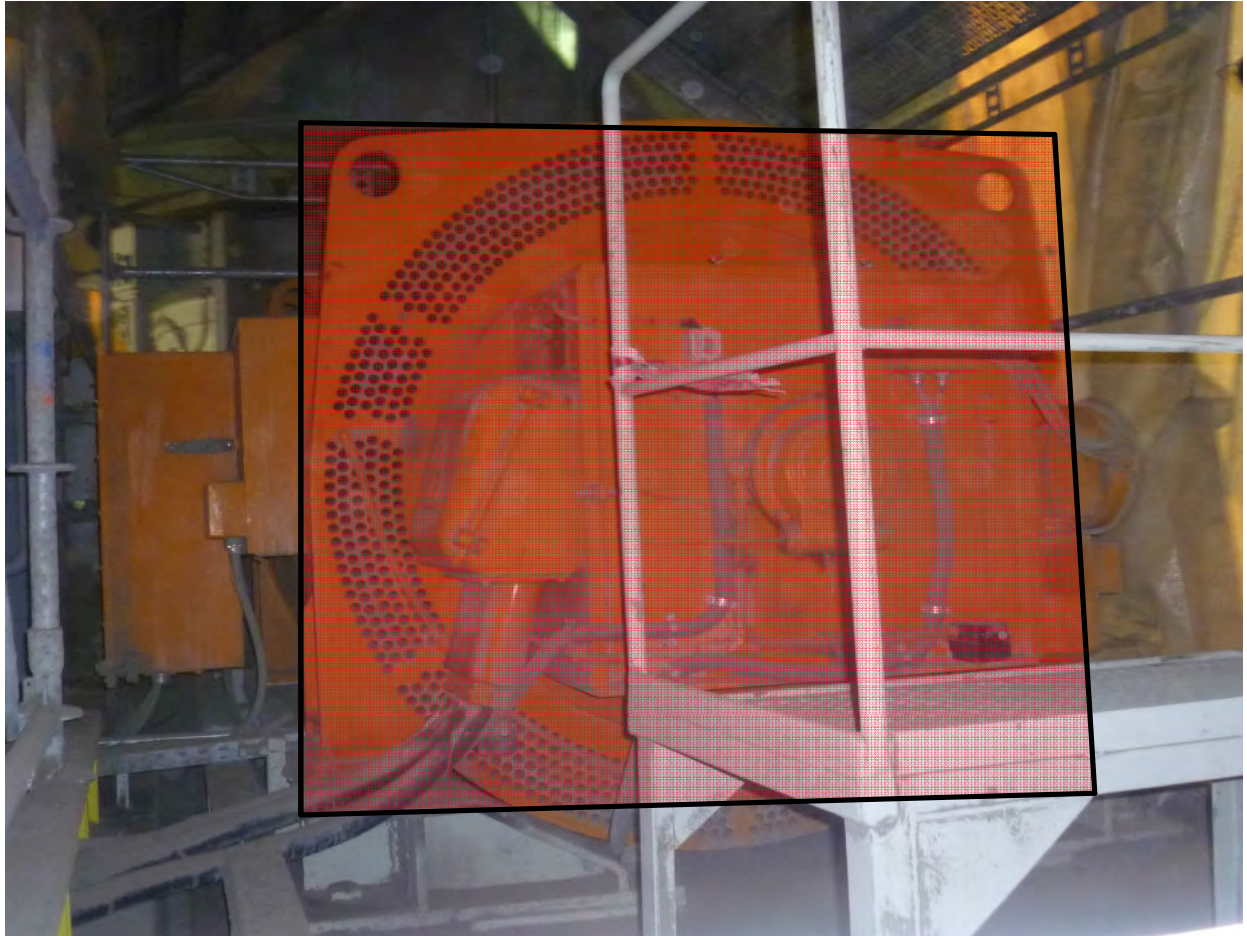

Messfläche: Länge: 1,80 m Breite: 0,70 m Höhe: 1,90 m

Schalleistungspegel Motor, Mühlenantrieb

Messfläche (S) = 7,3 m²

Frequenz in Hz		A-bew. Oktavpegel in dB(A)									Summe dB(A)
		32	63	125	250	500	1000	2000	4000	8000	
Schallintensitätspegel	L _{IA}	60,9	72,1	71,7	78,8	91,1	84,0	74,8	68,1	56,6	92,2
Messflächenmaß	L _s	8,7	8,7	8,7	8,7	8,7	8,7	8,7	8,7	8,7	
Schalleistungspegel	L_{WA}	69,6	80,8	80,4	87,4	99,7	92,7	83,4	76,8	65,3	100,9

Messergebnis: Schalleistungspegel Motor, Mühlenantrieb

L_{WA} = 101 dB(A)

Bemerkung: Auswertung in Anlehnung an die Norm

Genest und Partner Ingenieurgesellschaft mbH

Parkstraße 70

67061 Ludwigshafen

Projekt:

**Schalltechnische Vermessung der Rohmühle LM 46.2+2
der Firma Loesche GmbH**

Auftraggeber:

Firma Loesche GmbH, Hansaallee 243, 40549 Düsseldorf

Schalleistungspegel Mühlenventilator



Messfläche: Länge: 3,40 m Breite: 1,70 m Höhe: 1,70 m
(Besteht aus 2 x lange Seitenfläche, 1 x kurze Seitenfläche, 1 x Deckfläche)

Schalleistungspegel Mühlenventilator

Messfläche (S) = 20,2 m²

Frequenz in Hz		A-bew. Oktavpegel in dB(A)									Summe dB(A)
		32	63	125	250	500	1000	2000	4000	8000	
Schallintensitätspegel	L _{IA}	40,6	56,9	62,5	64,7	71,9	72,4	74,9	69,4	67,2	79,2
Messflächenmaß	L _S	13,1	13,1	13,1	13,1	13,1	13,1	13,1	13,1	13,1	
Schalleistungspegel	L _{WA}	53,7	69,9	75,6	77,8	85,0	85,5	88,0	82,4	80,3	92,2

Messergebnis: Schalleistungspegel Mühlenventilator

L_{WA} = 92 dB(A)

Bemerkung: Aufgrund der Fremdgeräuschsituation konnten die Pegel in den Oktaven 63 Hz bis 250 Hz nicht nach Norm ausgewertet werden (L_{pA} - L_{IA} > 10 dB). Die ausgewiesenen Pegel in diesen Oktaven sind als obere Abschätzung zu betrachten.

Genest und Partner Ingenieurgesellschaft mbH

Parkstraße 70

67061 Ludwigshafen

APPENDIX F
Equipment Drawings

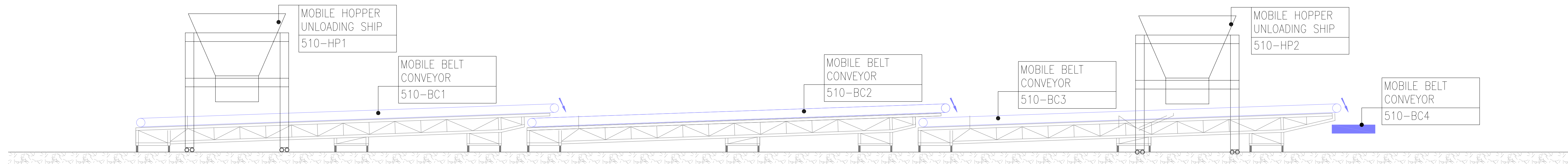

SECTION 1-1

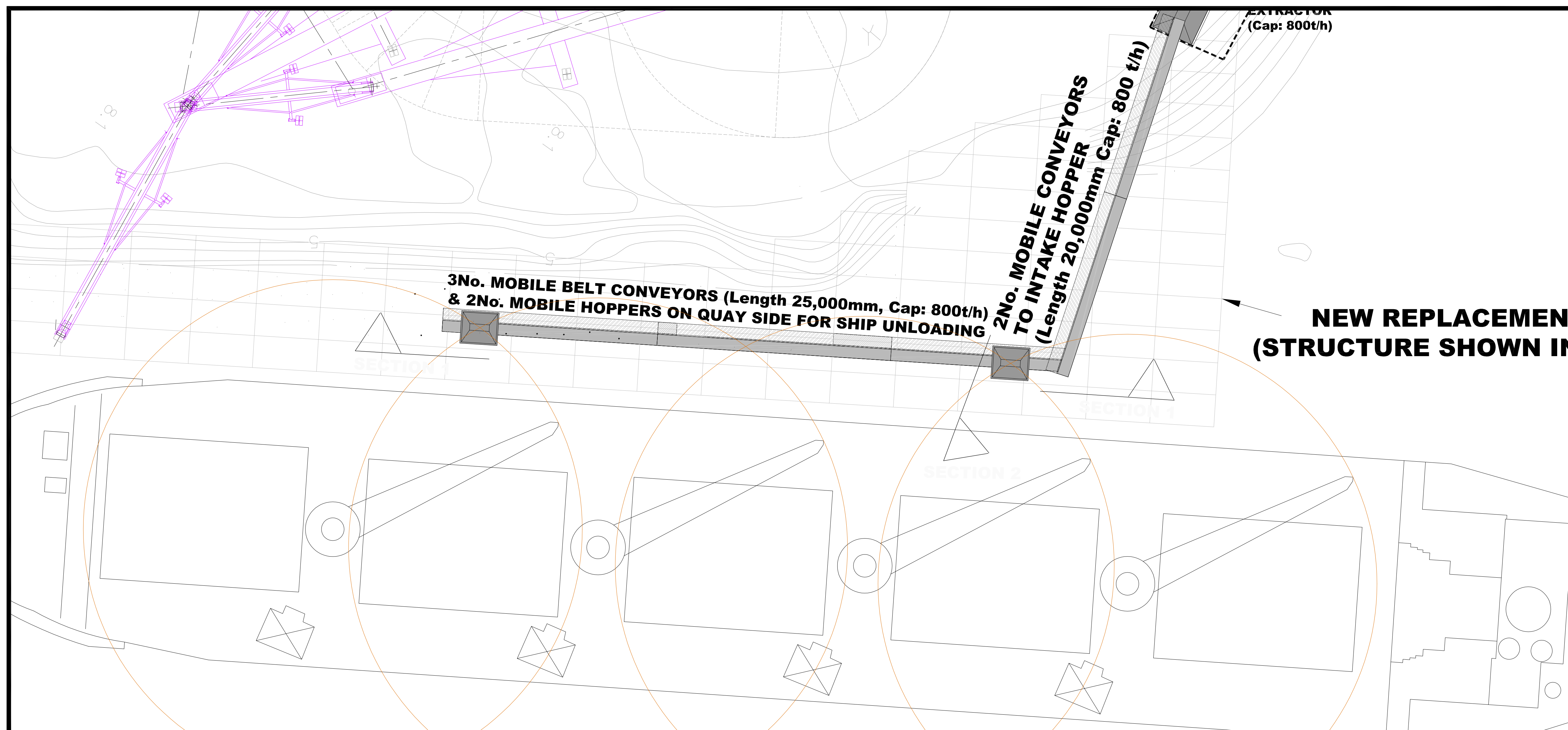

KEY PLAN

MOBILE HOPPERS & CONVEYORS OFF LOADING FROM SHIPS AT QUAY SIDE

Rev.	Date	By	Details Of Revision	Chk.	App.
Client					
ORCEM CALIFORNIA INC.					
Project					
VALLEJO SITE, PROPOSED PRODUCTION PLANT FACILITY					
EQUIPMENT LOCATIONS & CODES					
PHASE 2: CONVEYOR TRANSPORT PLANS & SECTIONS SHEET 1					
PROPERTY ADDRESS:			PROPERTY OWNER:		
VALLEJO MARINE TERMINAL 780 AND 790 DERR STREET VALLEJO CALIFORNIA 94598 TEL: +351 501 449 3244			VALLEJO MARINE TERMINAL LLC 4171 CANTON ROAD LAFFETTE CALIFORNIA 94549 PHONE: 510.261.2400		
KPFF					
Walsh Goodfellow Consulting Civil & Structural Engineers ADELAIDE CHAMBERS PETER STREET DUBLIN 4 TEL: +353 501 449 3244 FAX: +353 501 449 3245 E-MAIL: GJM@walshgroup.eu.com					
PROGRESS PRINT 29/01/14					
Drawn	RG	Scale	1" to 20' & 1" to 10' @ D		
Date	JUN 2014	Eng.	RG	Chk.	RG
File Ref.					
Drawing No.	5387-EQ-M2P2-601				Rev.

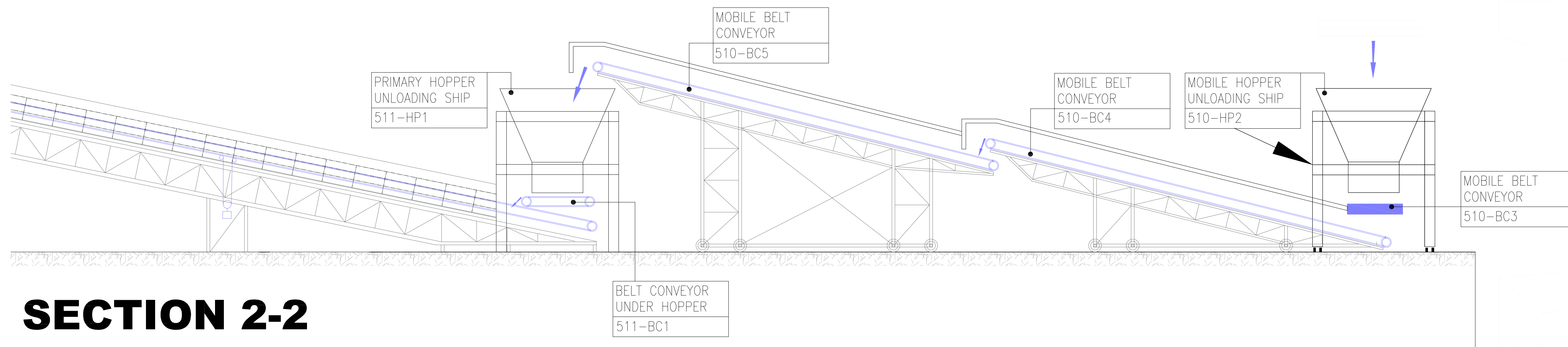

SECTION 2-2

KEY PLAN

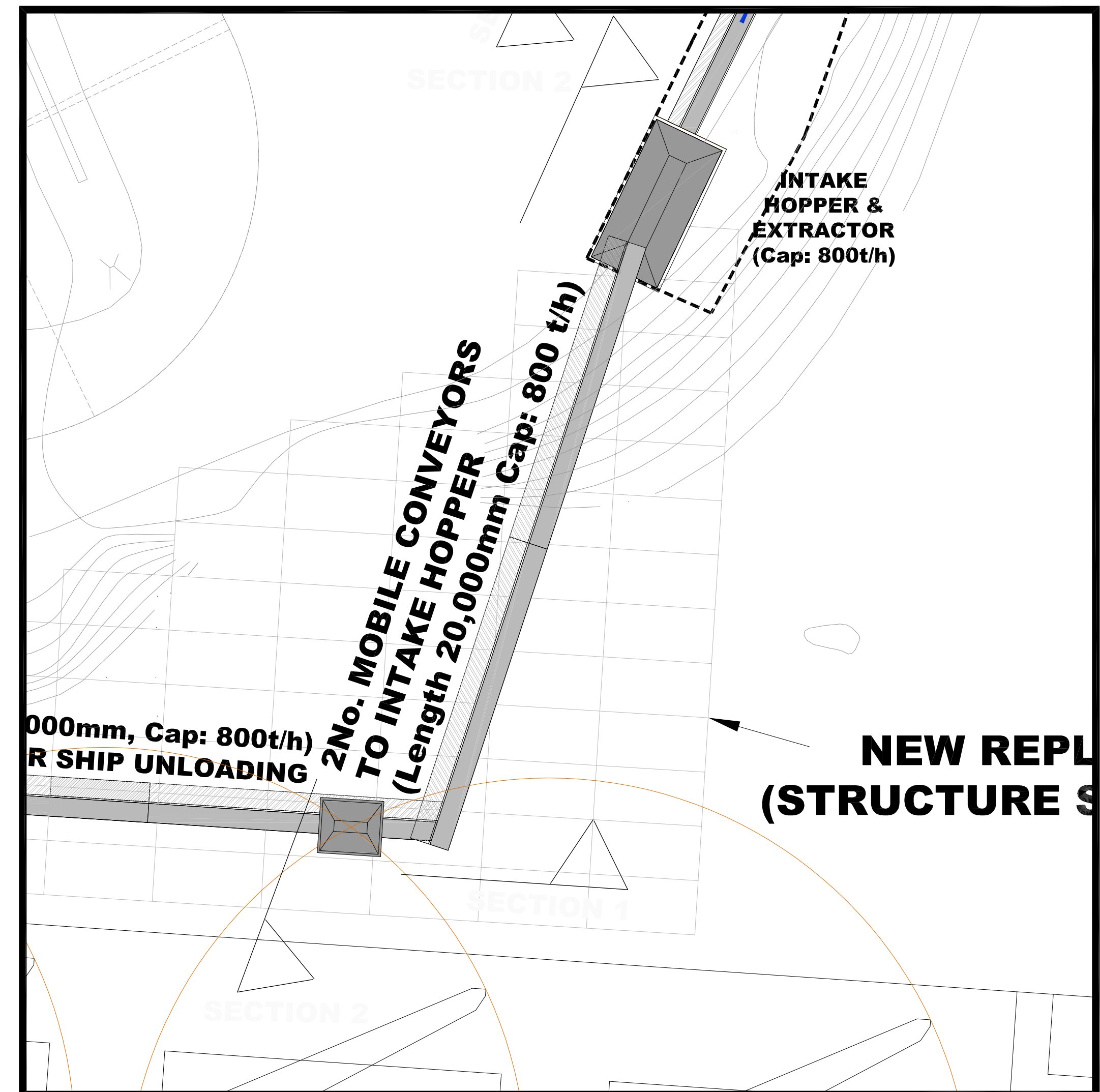

MOBILE CONVEYOR FROM QUAY SIDE TO PRIMARY UNLOADING HOPPER

Rev.	Date	By	Details Of Revision	Chk.	App.
Client					
ORCEM CALIFORNIA INC.					
Project					
VALLEJO SITE, PROPOSED PRODUCTION PLANT FACILITY					
EQUIPMENT LOCATIONS & CODES					
PHASE 2: CONVEYOR TRANSPORT PLANS & SECTIONS SHEET 2					
PROPERTY ADDRESS:			PROPERTY OWNER:		
VALLEJO MARINE TERMINAL 780 AND 790 DERR STREET VALLEJO CALIFORNIA TEL: +351 501 449 3244			VALLEJO MARINE TERMINAL LLC 4171 CANYON ROAD LAFFETTE CALIFORNIA 94549 PHONE: 510.261.2900		
KPFF					
Walsh Goodfellow Consulting Civil & Structural Engineers ADELAIDE CHAMBERS PETER STREET DUBLIN 8 TEL: +353 501 449 3244 FAX: +353 501 449 3245 E-MAIL: w.g.f@walshgroup.com.au					
State					
PROGRESS PRINT 29/01/14					
Drawn	RG	Scale	1" to 20' & 1" to 10' @ D		
Date	JUN 2014	Eng.	RG	Chk.	RG
File Ref.					
Drawing No.					
5387-EQ-M2P2-602					

D

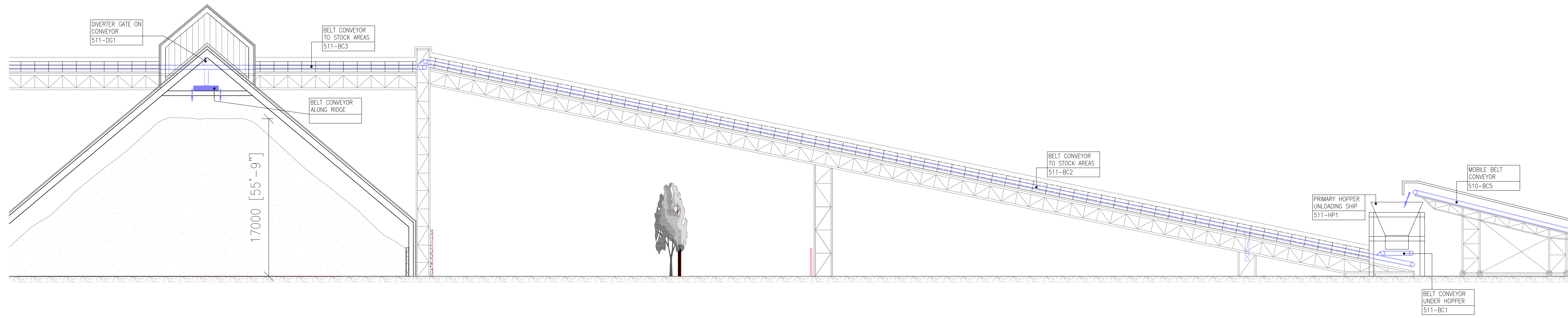

CLOSED RAW MATERIAL STORAGE BUILDING

SECTION 3-3

BELT CONVEYORS FROM PRIMARY UNLOADING HOPPER TO CLOSED RAW MATERIAL STORE

Notes

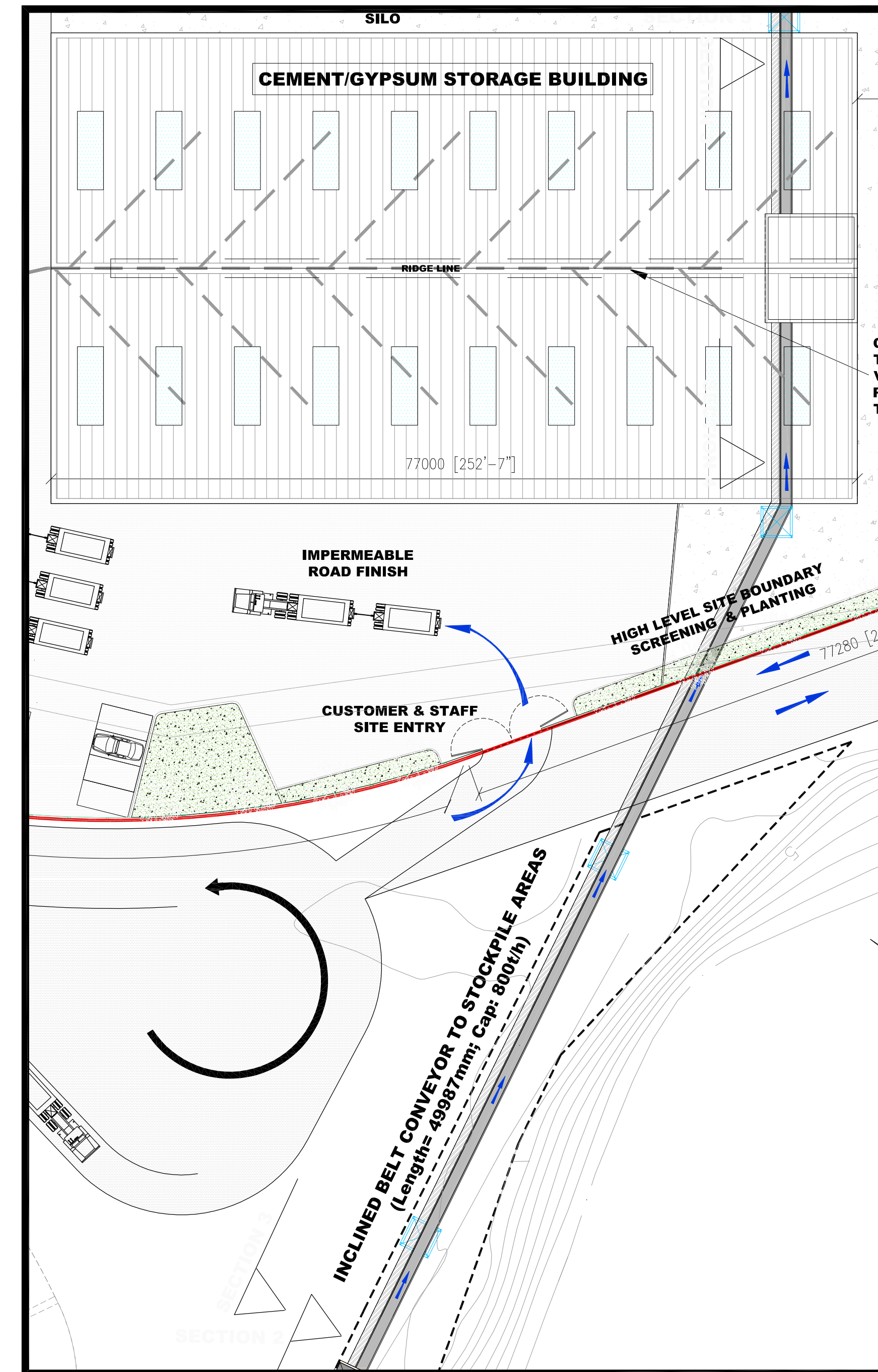

KEY PLAN

Rev.	Date	By	Details Of Revision	Chk.	App.
Client					
ORCEM CALIFORNIA INC.					
Project					
VALLEJO SITE, PROPOSED PRODUCTION PLANT FACILITY					
EQUIPMENT LOCATIONS & CODES					
PHASE 2: CONVEYOR TRANSPORT PLANS & SECTIONS SHEET 3					
PROPERTY ADDRESS:			PROPERTY OWNER:		
VALLEJO MARINE TERMINAL 780 AND 790 DERR STREET VALLEJO CALIFORNIA TEL: +353 201 449 3244			VALLEJO MARINE TERMINAL LLC 4171 CANYON ROAD LAFFETTE CALIFORNIA 94549 PHONE: 510.261.2400		
KPDFF					
Walsh Goodfellow Consulting Civil & Structural Engineers ADELAIDE CHAMBERS PETER STREET DUBLIN 4 TEL: +353 201 449 3244 FAX: +353 201 449 3245 E-MAIL: G.DON@walshgroup.com					
Status					
PROGRESS PRINT 29/01/14					
Drawn	RG	Scale	1" to 20' & 1" to 30' @ D		
Date	JUN 2014	Eng.	RG	Chk.	RG
File Ref.		App'g	RG		
Drawing No.					
5387-EQ-M2P2-603					

D

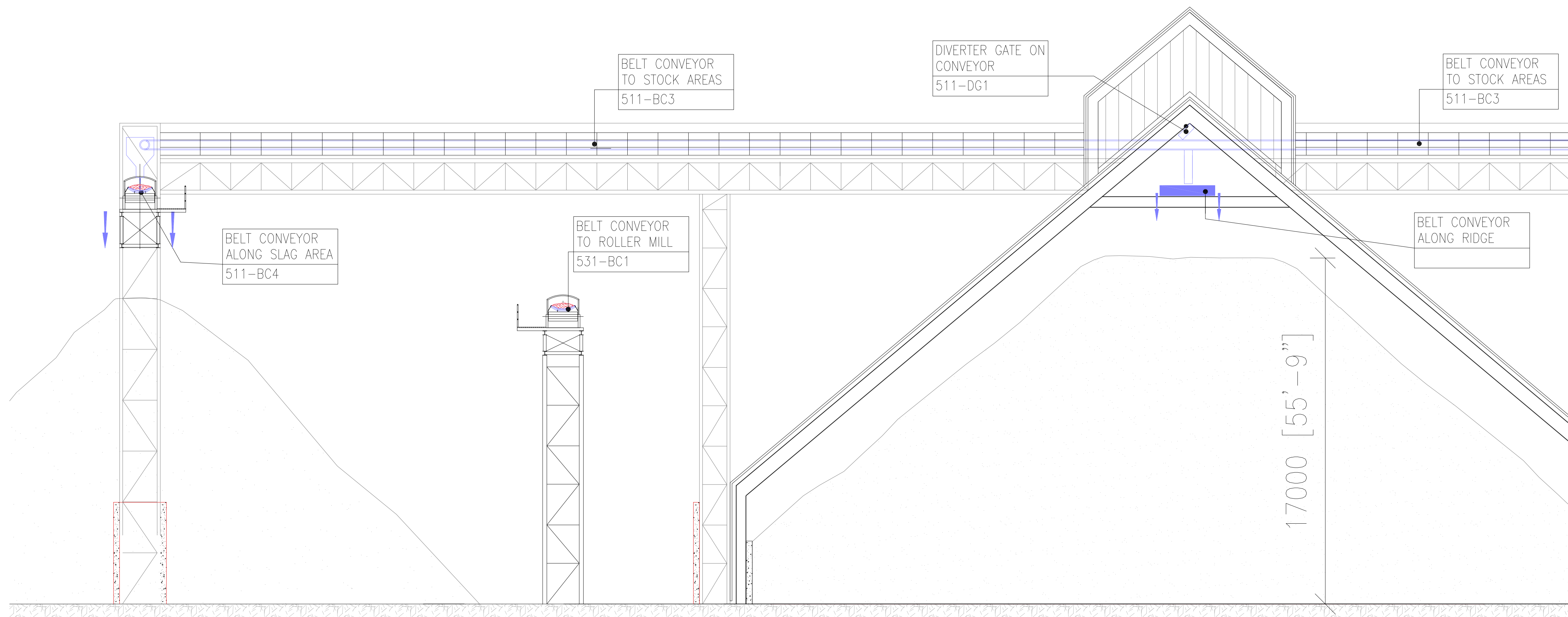

OPEN RAW MATERIAL STORAGE AREA

CLOSED RAW MATERIAL STORAGE BUILDING

SECTION 4-4

BELT CONVEYORS TO STOCK STORAGE AREAS

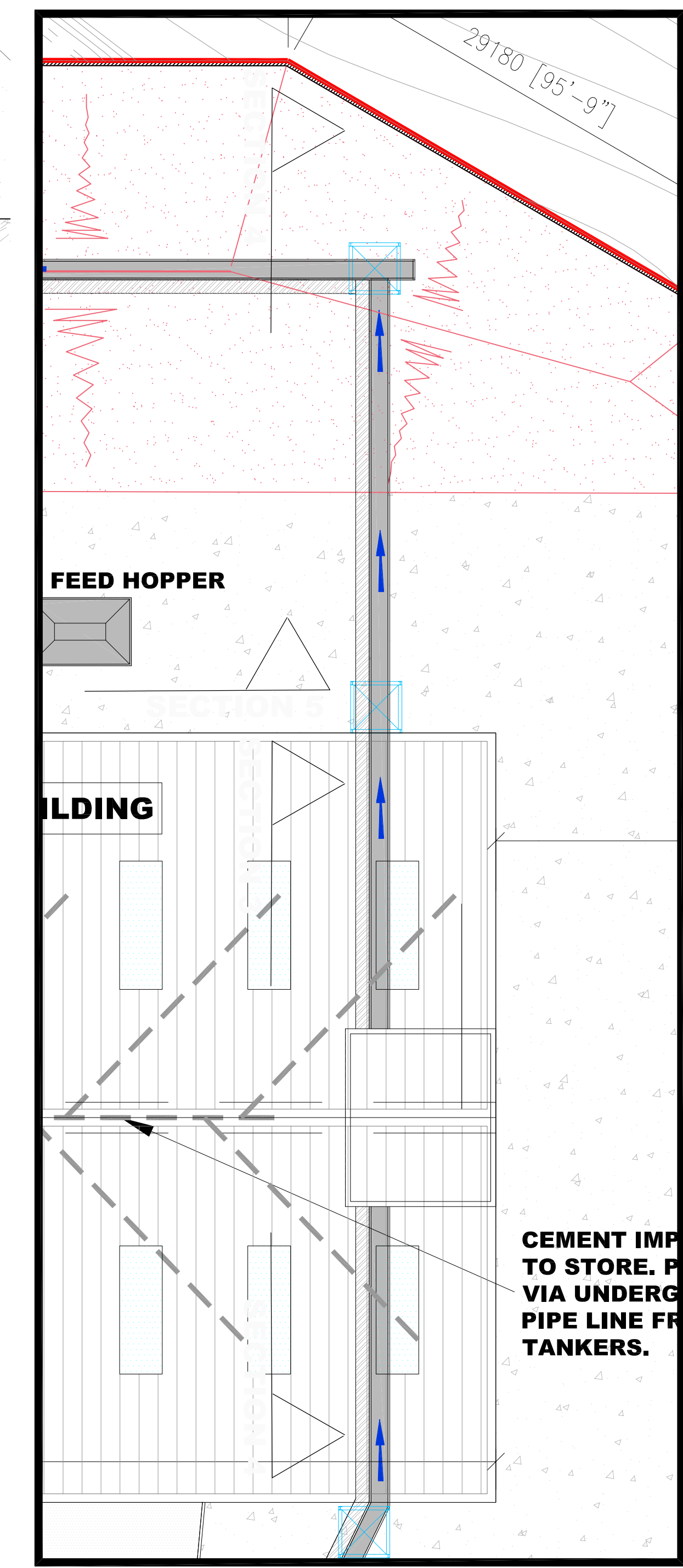

KEY PLAN

Notes

Rev.	Date	By	Details Of Revision	Chk.	App.

Client
ORCEM CALIFORNIA INC.

Project
VALLEJO SITE, PROPOSED PRODUCTION PLANT FACILITY
EQUIPMENT LOCATIONS & CODES
PHASE 2: CONVEYOR TRANSPORT PLANS & SECTIONS SHEET 4

PROPERTY ADDRESS: VALLEJO MARINE TERMINAL 780 AND 790 DERR STREET VALLEJO CALIFORNIA TEL: +352 551 449 3244	PROPERTY OWNER: VALLEJO MARINE TERMINAL LLC 4171 CANYON ROAD LAFFLETTE CALIFORNIA 94548 PHONE: 916.261.2400
--	--

KPFF

Walsh Goodfellow
Consulting Civil & Structural Engineers
ADELAIDE CHAMBERS
PETER STREET DUBLIN 8
TEL: +353 011 469 3244
FAX: +353 011 469 3245
E-MAIL: g.don@walshgroup.eu.com

State
PROGRESS PRINT 29/01/14

Drawn	RG	Scale	1" to 20' & 1" to 10' @ D
Date	JUN 2014	Eng.	RG
File Ref.		Chk.	RG
		App'g	RG

ACTUAL DIMENSION

Drawing No.	Rev.
5387-EQ-M2P2-604	

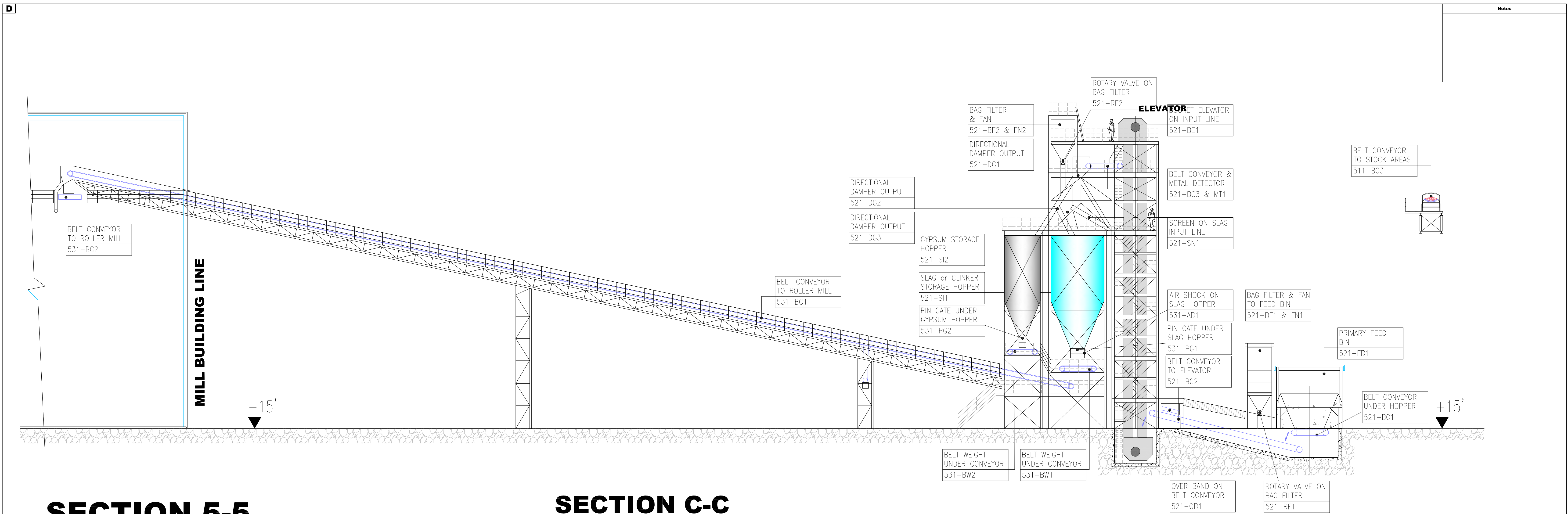

SECTION 5-5

SECTION C-C

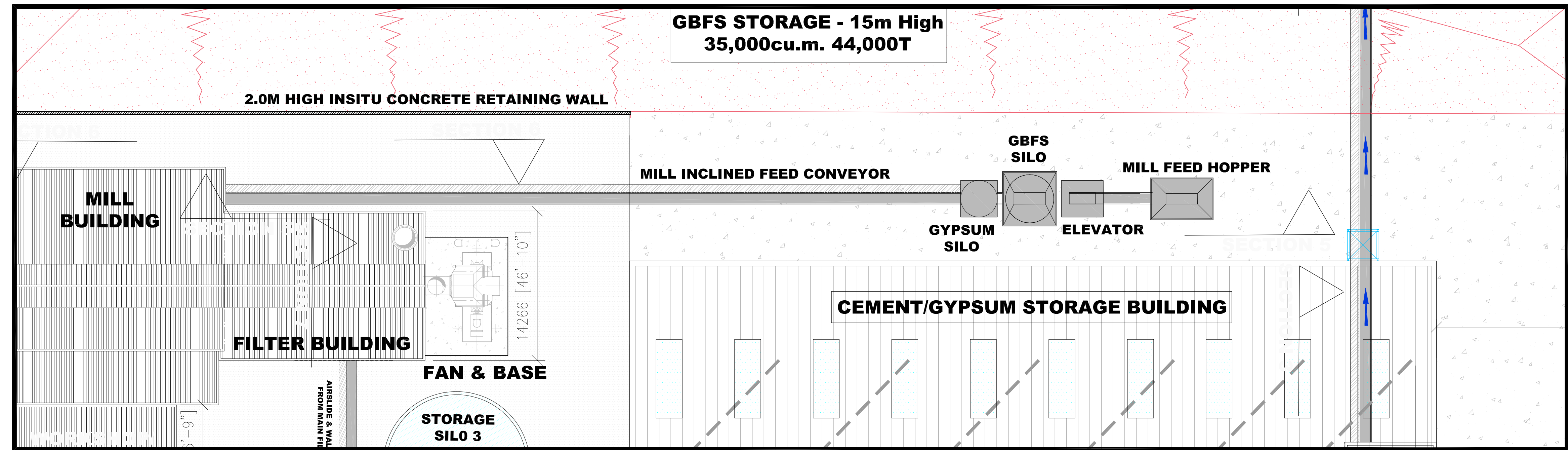

KEY PLAN

PRIMARY INTAKE HOPPERS, SILOS, ELEVATOR AND MILL FEED CONVEYORS

Notes

Rev.	Date	By	Details Of Revision	Chk.	App.

Client: ORCEM CALIFORNIA INC.

Project: VALLEJO SITE, PROPOSED PRODUCTION PLANT FACILITY

EQUIPMENT LOCATIONS & CODES

PHASE 2: CONVEYOR TRANSPORT PLANS & SECTIONS SHEET 5

PROPERTY ADDRESS: VALLEJO MARINE TERMINAL 780 AND 790 DERR STREET WALLEJO CALIFORNIA 94588 TEL: +353 (0)1 449 3244

PROPERTY OWNER: VALLEJO MARINE TERMINAL 4175 CANYON ROAD LAPELLE CALIFORNIA 94548 PHONE: 708.262.2800

KPFF

Walsh Goodfellow
Consulting Civil & Structural Engineers
ADELAIDE CHAMBERS
PETER STREET DUBLIN 4
TEL: +353 (0)1 449 3244
FAX: +353 (0)1 449 3245
E-mail: g.walsh@walshgroup.eu.com

State: **PROGRESS PRINT 29/01/14**

Drawn: RG Scales: 1" to 20' & 1" to 10' @ D
Date: JUN 2014 Eng: RG Chk: RG App: RG
File Ref:
Drawing No. 5387-EQ-M2P2-605

D

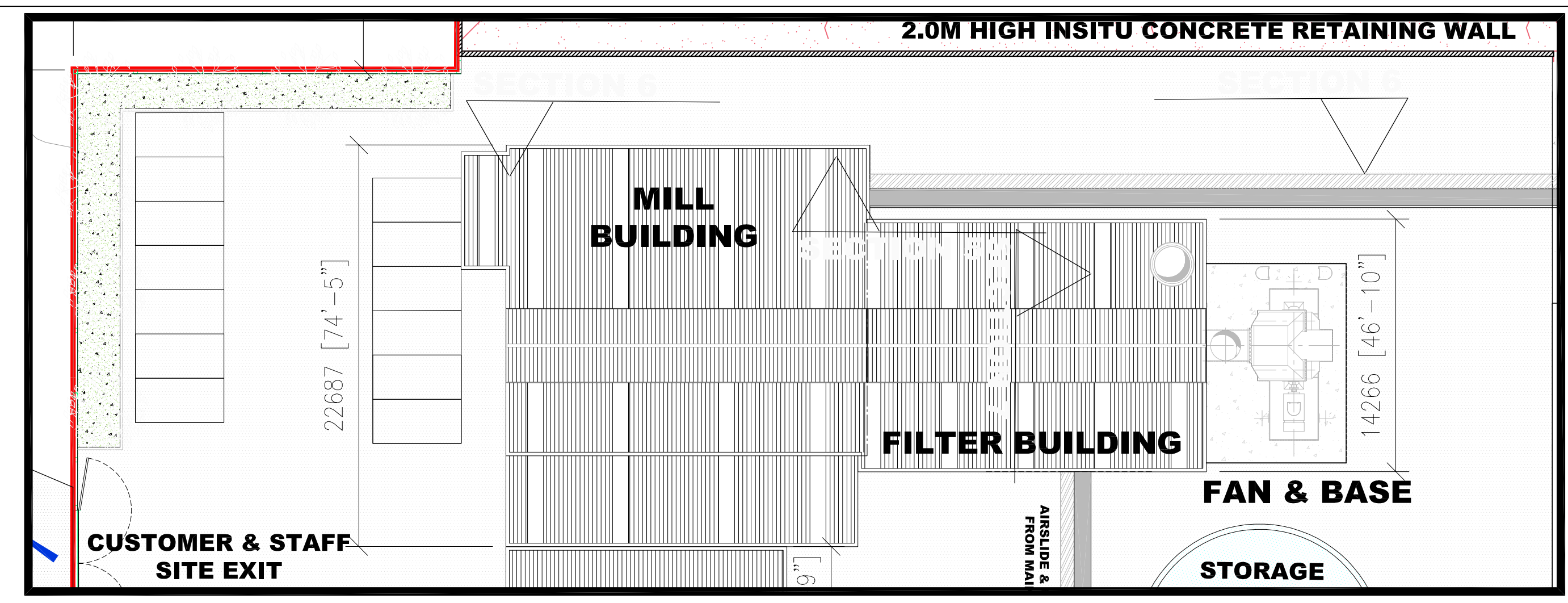
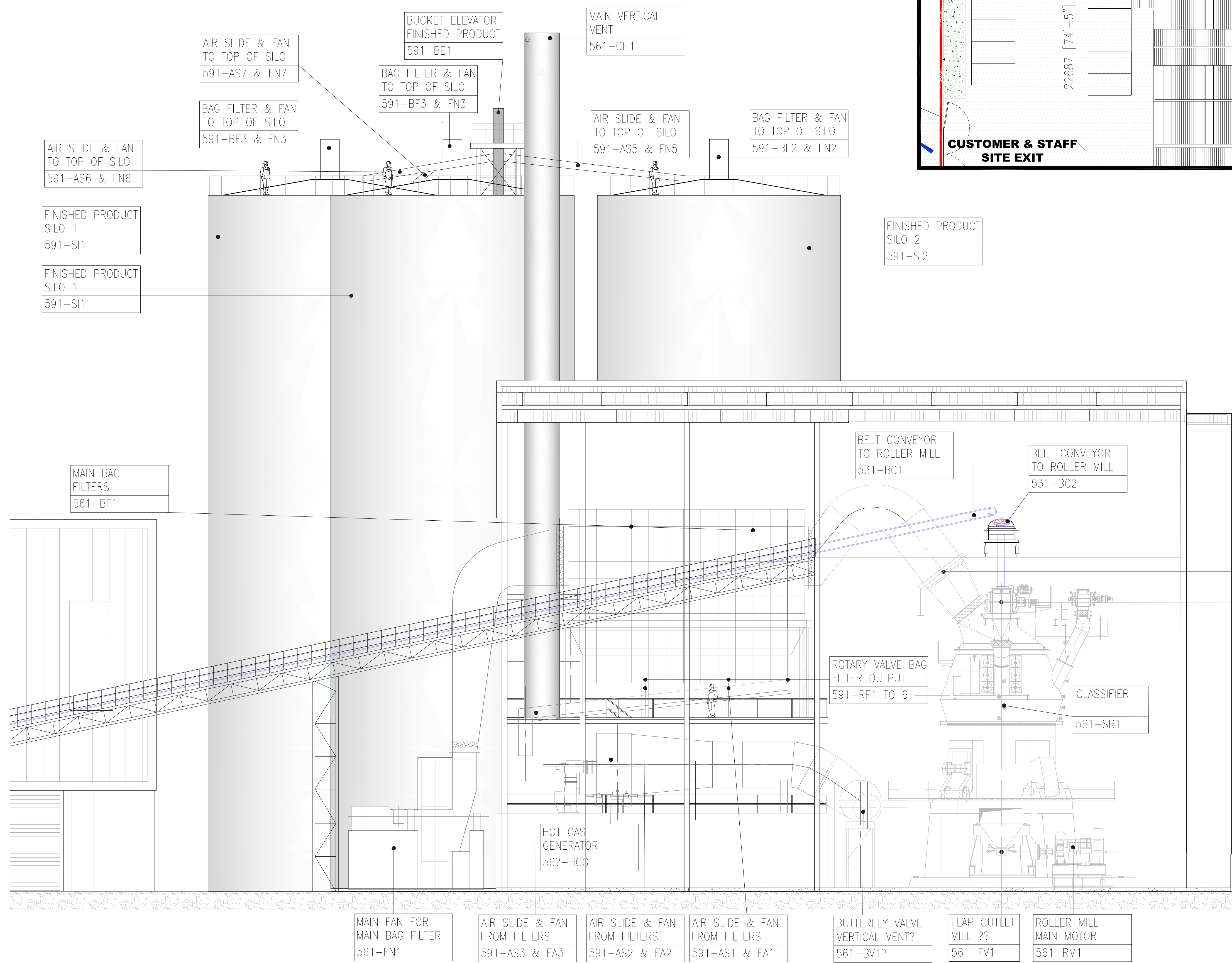

KEY PLAN

- SEAL FAN ON MILL??
561-FN3
- DIRECTION DAMPER OUTPUT
561-SG1
- BUCKET ELEVATOR IN LOOP GRINDING
561-BE1
- DIRECTION DAMPER OUTPUT
561-SG2
- AIR SHOCK INLET ROLLER MILL
531-AB2
- METAL SEPARATOR OUTLET
561-MD1
- BAG FILTER & FAN
561-BF2 & FN2
- TRANSITION PRODUCT HOPPER
561-SI3
- WEIGHT FEEDER UNDER HOPPER
561-WF1

SECTION 6-6 ROLLER MILL & MAIN FILTER FACILITY

- MAIN FAN FOR MAIN BAG FILTER
561-FN1
- AIR SLIDE & FAN FROM FILTERS
591-AS3 & FA3
- AIR SLIDE & FAN FROM FILTERS
591-AS2 & FA2
- AIR SLIDE & FAN FROM FILTERS
591-AS1 & FA1
- BUTTERFLY VALVE VERTICAL VENT?
561-BV1?
- FLAP OUTLET MILL ??
561-FV1
- ROLLER MILL MAIN MOTOR
561-RM1
- METAL DETECTOR WEIGHT FEEDER
561-MT1
- DIVERTER GATE HOPPER OUTLET
- BELT CONVEYOR TO ELEVATOR

Notes

Rev.	Date	By	Details Of Revision	Chk.	App.

Client: **ORCEM CALIFORNIA INC.**

Project: **VALLEJO SITE, PROPOSED PRODUCTION PLANT FACILITY**

EQUIPMENT LOCATIONS & CODES

PHASE 2: CONVEYOR TRANSPORT PLANS & SECTIONS SHEET 6

PROPERTY ADDRESS: VALLEJO MARINE TERMINAL, 700 AND 700 DERR STREET, VALLEJO, CALIFORNIA 94590, TEL: +1(530) 449 3244

PROPERTY OWNER: VALLEJO MARINE TERMINAL LLC, 4171 CANTON ROAD, LAPEL, CALIFORNIA 94549, PHONE: 510.251.2400

KPFF

Walsh Goodfellow
Civil, Mechanical & Structural Engineers

ADELAIDE CHAMBERS
PETER EMBERT, SUZANNE
TEL: +33(0)1 449 3244
FAX: +33(0)1 449 3245
E-MAIL: ocm@walshgroup.com

Status: **PROGRESS PRINT 29/01/14**

Drawn	RG	Scale	1" to 20' & 1" to 10' @ D		
Date	JAN 2014	Eng.	RG	Chk.	RG
App'd.	RG				

ACTUAL DIMENSION -

Drawing No. **5387-EQ-M2P2-606**

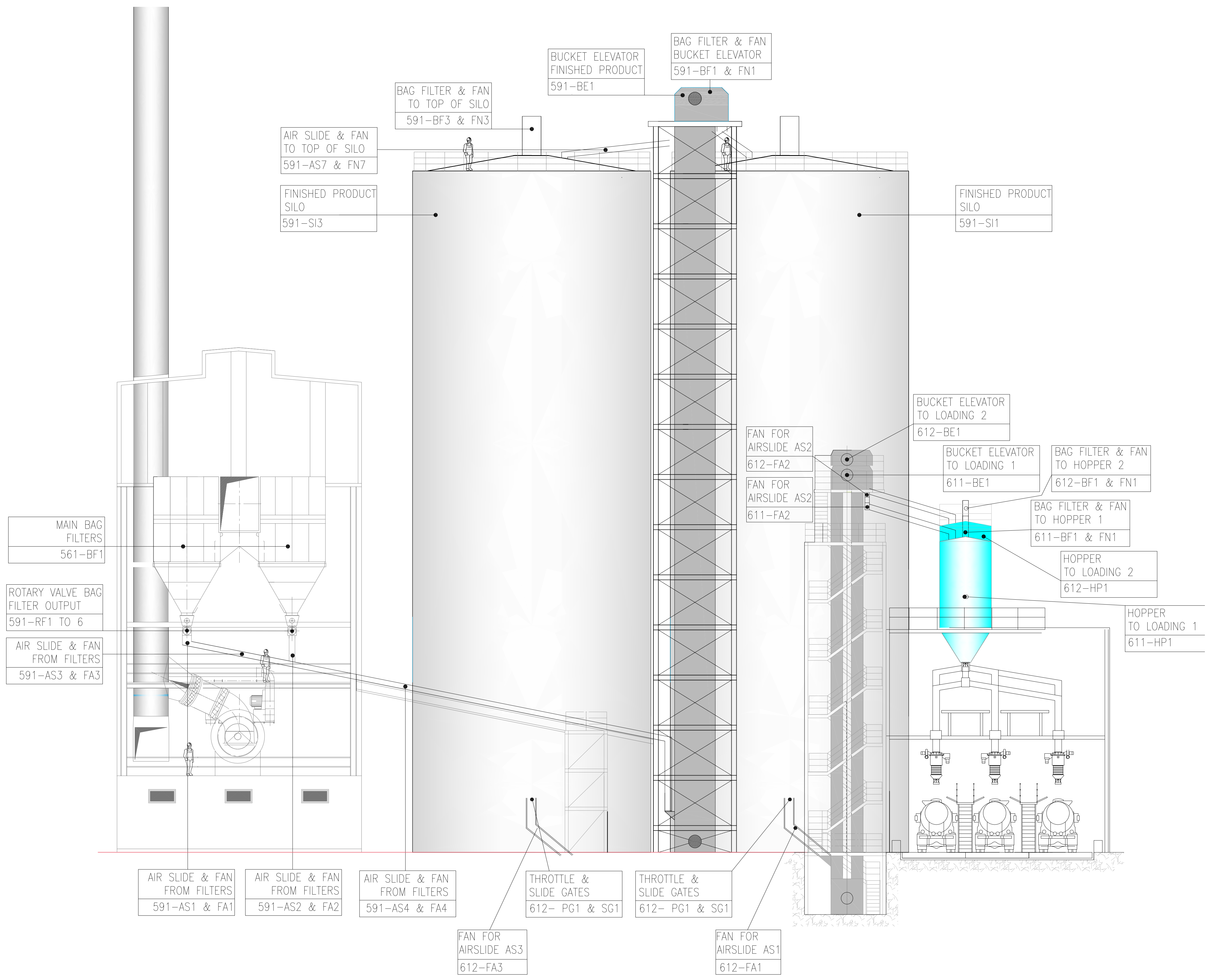

SECTION 7-7

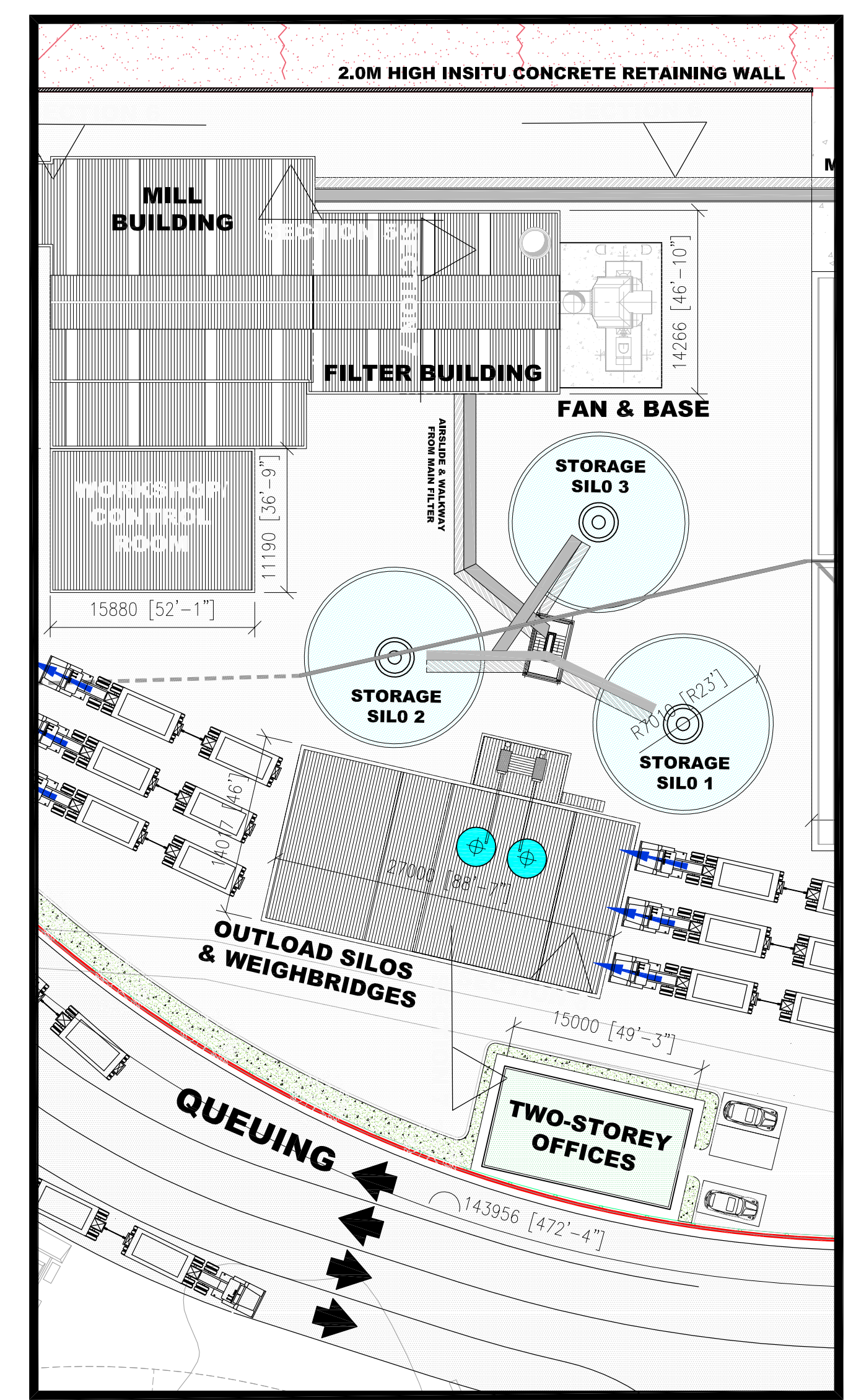

KEY PLAN

MAIN FILTERS, AIRSLIDES, ELEVATORS & FINISHED PRODUCT OUTPUT FACILITY

Rev.	Date	By	Details Of Revision	Chk.	App.

Client: ORCEM CALIFORNIA INC.

Project: VALLEJO SITE, PROPOSED PRODUCTION PLANT FACILITY

EQUIPMENT LOCATIONS & CODES

PHASE 2: CONVEYOR TRANSPORT PLANS & SECTIONS SHEET 7

PROPERTY ADDRESS: VALLEJO MARINE TERMINAL, 780 AND 790 DERR STREET, VALLEJO, CALIFORNIA 94598, TEL: +1(925) 449-3244

PROPERTY OWNER: VALLEJO MARINE TERMINAL, LLC, 4171 CANYON ROAD, LAFFETTE, CALIFORNIA 94549, PHONE: 510.925.2400

KPFF

Walsh Goodfellow
Consulting Civil & Structural Engineers
ADELAIDE CHAMBERS
FILTER STREET, SUITE 200, VALLEJO, CA 94591
Tel: +1(925) 449-3244
Fax: +1(925) 449-3245
Email: a.chambers@wagroup.com

Status: **PROGRESS PRINT 29/01/13**

Drawn	RC	Scale	1" to 20' & 1" to 10' @ D
Date	JAN 2014	Eng.	RC
Chk.	RC	App'l.	RC

File Ref: **5387-EQ-M2P2-607**

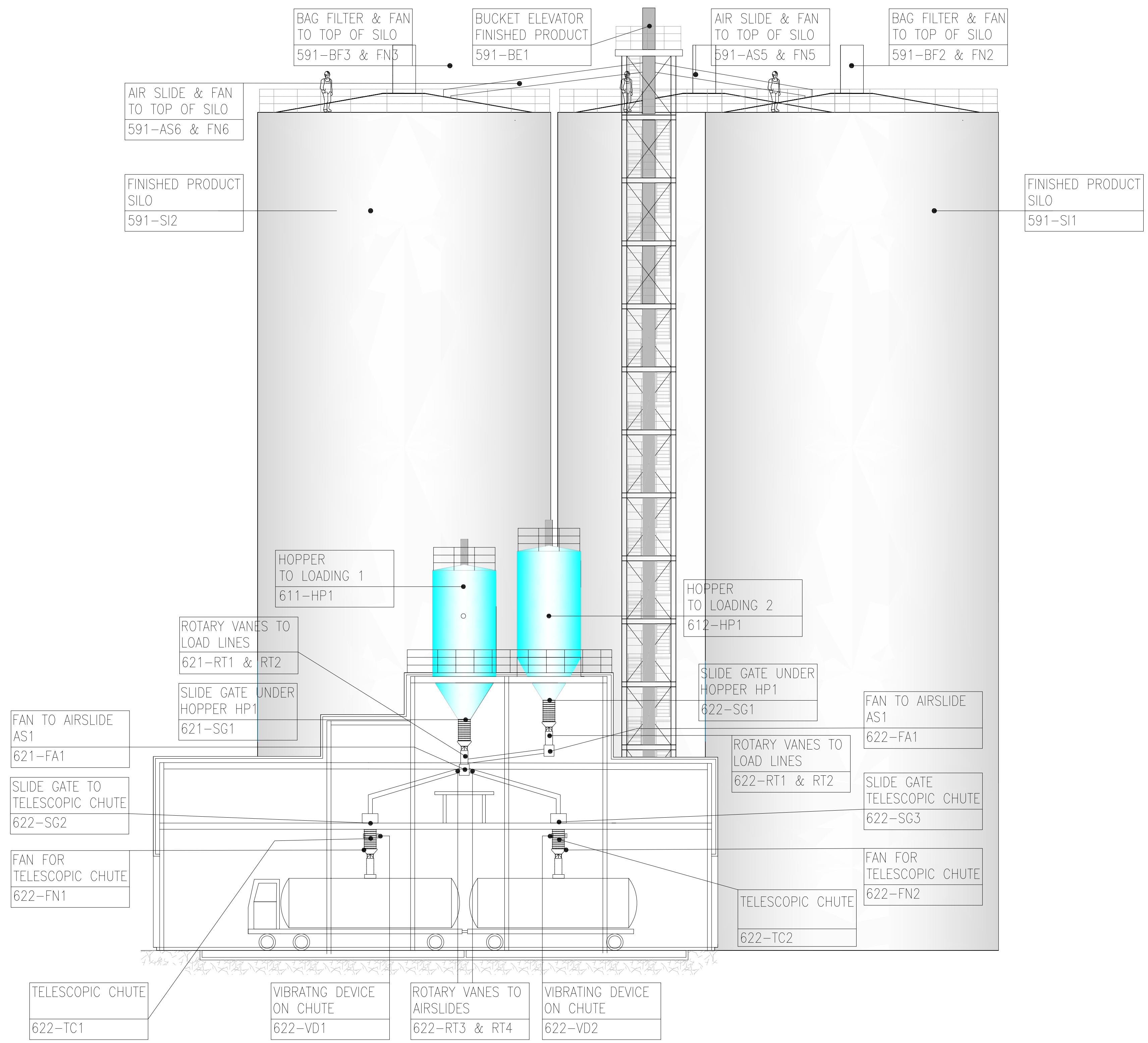

SECTION 8-8

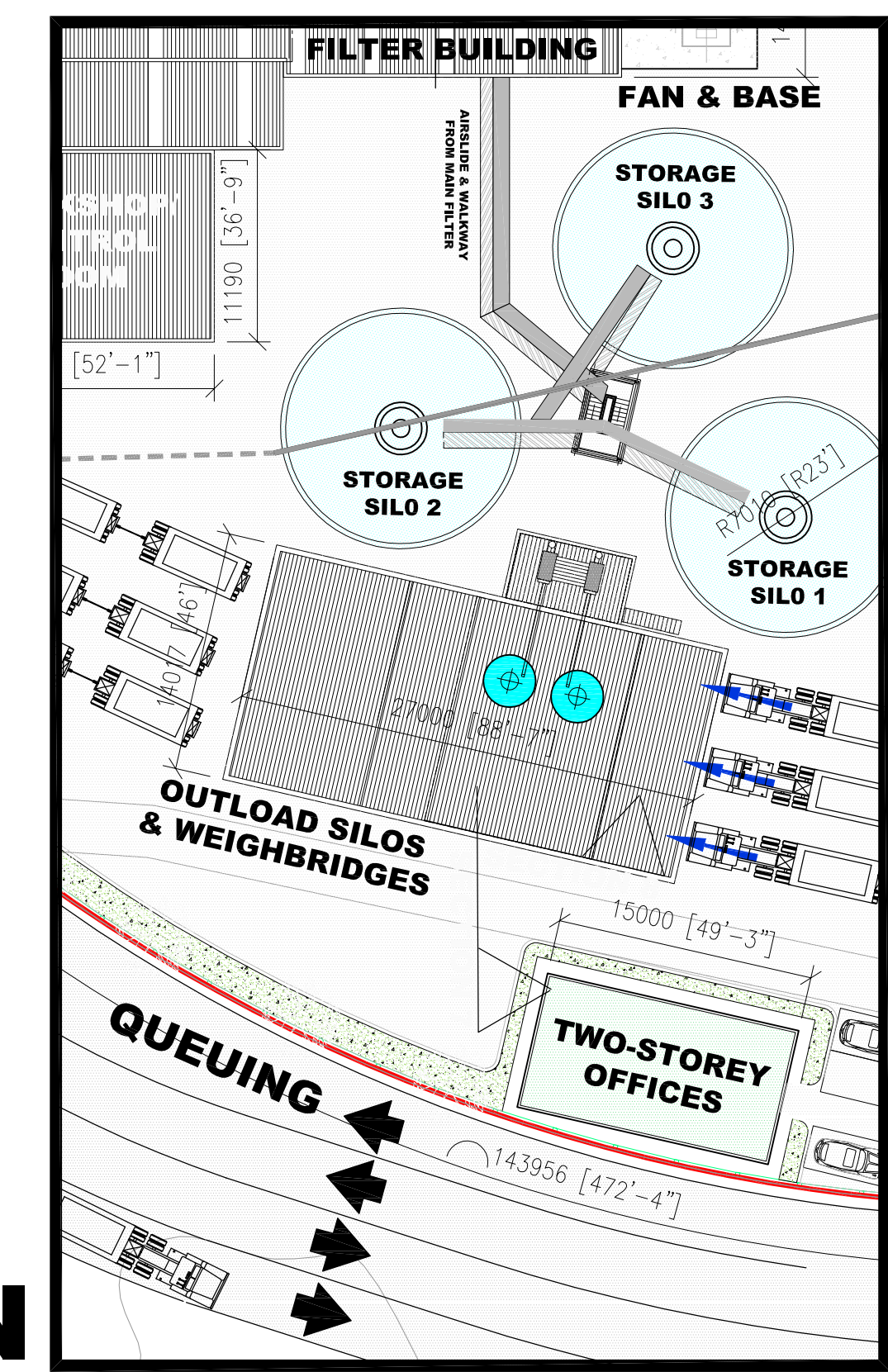

KEY PLAN

FINISHED PRODUCT OUTPUT FACILITY

Rev.	Date	By	Details Of Revision	Chk.	App.
Client					
ORCEM CALIFORNIA INC.					
Project					
VALLEJO SITE, PROPOSED PRODUCTION PLANT FACILITY					
Equipment Locations & Codes					
PHASE 2: CONVEYOR TRANSPORT PLANS & SECTIONS SHEET 8					
Property Address			Property Owner		
VALLEJO MARINE TERMINAL 780 AND 790 DERR STREET VALLEJO, CALIFORNIA 94598 Tel: +931 (91) 449 3244			VALLEJO MARINE TERMINAL, LLC 4171 CANYON ROAD LAFFETTE, CALIFORNIA 94549 PHONE: 925.261.2400		
Status					
KPFF					
Walsh Goodfellow Consulting Civil & Structural Engineers ADELAIDE CHAMBERS FILTER BUILDING BUILDING 8 Tel: +931 (91) 449 3244 Fax: +931 (91) 449 3244 E-mail: a.walsh@wagroup.com.au					
Drawing No. 5387-EQ-M2P2-608					

APPENDIX G

Strouhal Number Correction for Stack Noise Emissions

EXHAUST DIRECTIVITY (3m diamater)

Angle off axis for nearest noise sensitive location (NSL2)

Height source 50 m
 Height Reciever 41 m
 Distance 200 m
 Degrees off axis **93 degrees**
 d (diamater of stack/duct) 3 m
 c (based on 100 degrees C) 387 m/s

fd/c	31.5	63	125	250	500	1000	2000	4000	8000
	0.24	0.49	0.97	1.94	3.88	7.75	15.50	31.01	62.02

Noise Reduction due to Directivity									
31.5	63	125	250	500	1K	2K	4K	8K	
0	-2	-8	-10	-14	-18	-20	-20	-20	-20

From Figure 9.27 (Bies and Hansen) for 90degrees

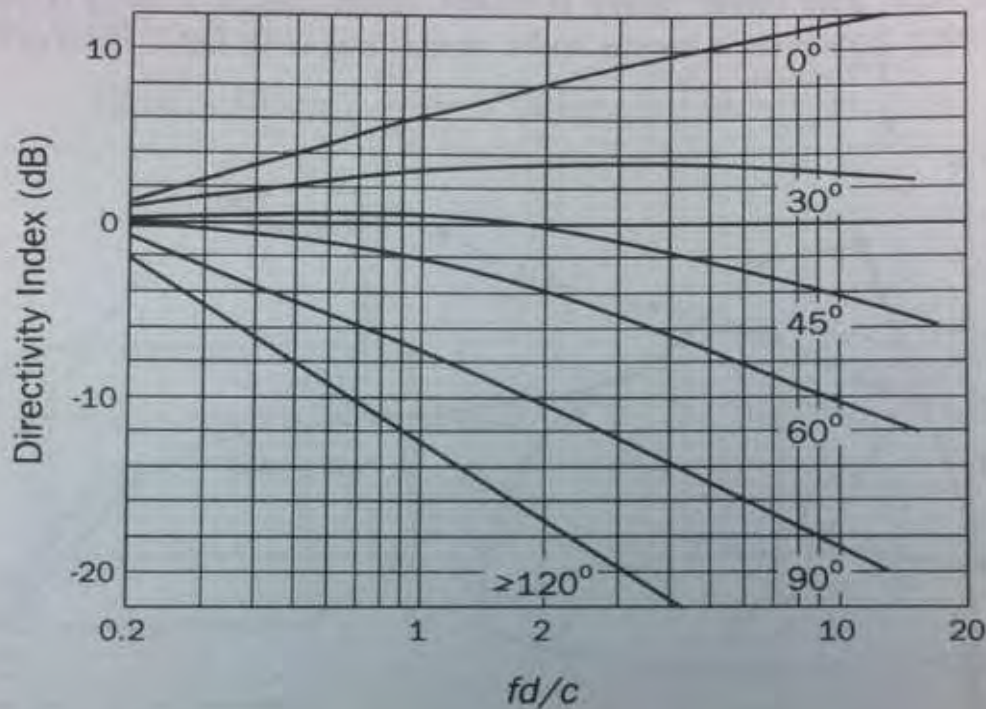

Figure 9.25 Exhaust stack directivity information based on an experimental model investigation. The quantity d is the diameter of the stack, f is the center band frequency in one-third octaves, and c (343 m s^{-1}) is the speed of sound in the exhaust gas at the stack exit. The indicated angle is measured from the centerline of the duct.

APPENDIX H
Noise Model Details

H.0 NOISE MODEL AND ASSESSMENT ASSUMPTIONS

The following sections discuss the noise modeling methodologies used to predict the calculated noise levels discussed throughout this report. In summary the following calculation methodologies have been used:

- ISO 9613-2:1996 Acoustics – Attenuation of sound outdoors – Part 2: General method of calculation.
- Federal Highway Administration's Traffic Noise Model®(FHWA TNM), Version 2.5

H.1 ISO9613

H1.1 Noise Propagation Calculation

Brüel & Kjær Predictor Type 7810 is a proprietary noise calculation package for computing noise levels in the vicinity of industrial sites. Calculations are based on ISO 9613-2:1996 Acoustics – Attenuation of sound outdoors – Part 2: General method of calculation. This method has the scope to take into account a range of factors affecting the sound propagation, including:

- the magnitude of the noise source in terms of sound power;
- the distance between the source and receiver;
- the presence of obstacles such as screens or barriers in the propagation path;
- the presence of reflecting surfaces;
- the hardness of the ground between the source and receiver;
- attenuation due to atmospheric absorption;
- meteorological effects such as wind gradient, temperature gradient, humidity (these have significant impact at distances greater than approximately 1,310').

Calculations have been performed in octave bands from 63Hz to 8kHz as well as in overall dB(A) terms.

H1.2 Brief Description of ISO 9613-2: 1996

ISO 9613-2:1996 calculates the noise level based on each of the factors discussed previously in Section H1.1. However, the effect of meteorological conditions is significantly simplified by calculating the average downwind sound pressure level, $L_{AT}(DW)$, for the following conditions:

- wind direction at an angle of $\pm 45^\circ$ to the direction connecting the centre of the dominant sound source and the centre of the specified receiver region with the wind blowing from source to receiver, and;
- wind speed between approximately 3fts^{-1} and 15fts^{-1} , measured at a height of 10ft to 36ft above the ground.

The equations and calculations also hold for average propagation under a well-developed moderate ground based temperature inversion, such as commonly occurs on clear calm nights.

The basic formula for calculating $L_{AT}(DW)$ from any point source at any receiver location is given by:

$$L_{FT}(DW) = L_W + D_c - A \quad \text{Eqn. H.1.1}$$

Where:

$L_{FT}(DW)$ is an octave band centre frequency component of $L_{AT}(DW)$ in dB relative to $2 \times 10^{-5} \text{Pa}$;
 L_W is the octave band sound power of the point source;
 D_c is the directivity correction for the point source;
 A is the octave band attenuation that occurs during propagation, namely attenuation due to geometric divergence, atmospheric absorption, ground effect, barriers and miscellaneous other effects.

The estimated accuracy associated with this methodology is shown in Table H1 below:

Height, h^*	Distance, d^\dagger	
	$0 < d < 330'$	$330' < d < 3,280'$
$0 < h < 16'$	$\pm 3\text{dB}$	$\pm 3\text{dB}$
$16' < h < 100'$	$\pm 1\text{dB}$	$\pm 3\text{dB}$

Table H1 Estimated accuracy for broadband noise of $L_{AT}(DW)$

* h is the mean height of the source and receiver in feet.
 † d is the mean distance between the source and receiver in feet.

N.B. These estimates have been made from situations where there are no effects due to reflections or attenuation due to screening.

H1.3 Initial Configuration of the Noise Model

The input to the noise model was an overall site plan, a set of buildings and noise sources. The buildings in the model were restricted to those on the development site, adjacent buildings and nearby noise sensitive locations. The ground model has been developed from the topographical survey of the site that has been provided. Figures H1 and H2 illustrate the noise model developed for the Orcem operation illustrating how the surrounding topography has been included.



Figure H1 Noise Model Topography



Figure H2 Noise Model Topography in Google Earth

Each noise source was input as sound power in octave bands. The Brüel & Kjær Predictor software accepts sound power levels in octave bands from 63Hz to 8kHz. Each source also has its own position, height and directivity.

In terms of the calculation, a ground attenuation factor (general method) of 1.0 and no metrological correction were assumed for all calculations. The following atmospheric attenuation was assumed for all calculations.

Temp (°F)	% Humidity	Octave Band Centre Frequencies (Hz)							
		63	125	250	500	1k	2k	4k	8k
68	50	0.03	0.12	0.44	1.31	2.73	4.66	9.89	29.67

Table H2 Atmospheric Attenuation Assumed for Noise Calculations (dB per km)

H1.4 Output of the Noise Model

Predicted noise levels are calculated for a set of receiver points, which can be chosen by the user. The results include an overall level in dB(A) and an A-weighted spectrum for each item in a list of the contributing sources. The items in the list can be ranked in order of their contribution, and thus the noisiest items can be identified.

H.2 **TNM V2.5**

H2.1 Noise Propagation Calculation

Brüel & Kjær Predictor Type 7810 is a proprietary noise calculation package for computing noise levels in the vicinity of road networks. Calculations are based on Federal Highway Administration's Traffic Noise Model®(FHWA TNM), Version 2.5 Calculation module. This method has the scope to take into account a range of factors affecting the sound propagation, including:

- the A-weighted 1/3rd octave band noise emission data for a range of vehicle and pavement types;
- the distance between the source and receiver;
- the presence of obstacles such as screens or barriers in the propagation path;
- the presence of reflecting surfaces;
- the hardness of the ground between the source and receiver;
- attenuation due to atmospheric absorption;

Calculations are performed in octave bands from 63Hz to 8kHz and presented in overall dB(A) terms.

H2.2 Initial Configuration of the Noise Model

The input to the noise model was an overall site plan, a set of buildings and noise sources. The buildings in the model were restricted to those on the development site and those adjacent to the local road network. The ground model has been developed from the topographical survey of the site that has been provided.

In terms of the calculation the following default calculation settings were used:

- Relative humidity – 50%;
- Temperature - 68°F, and;
- Default ground type – Lawn.

H2.3 Output of the Noise Model

Predicted noise levels are calculated for a set of receiver points, which can be chosen by the user. The results include an overall level in dB(A) and an A-weighted spectrum for each item in a list of the contributing sources. The items in the list can be ranked in order of their contribution, and thus the noisiest items can be identified.

APPENDIX I
Plant Noise Model Results

Report: Table of Control
 Model: Mode 1 Phase 1
 Path: C:\Users\ssmyth.AWNCONSULTING\Documents\Temp Predictor Models\Ecoecem\
 Group: (main group)
 Period: Ldn

Name	Description	NSL10 A	NSL1 A	NSL2 A	NSL3 A	NSL4 A	NSL5 A	NSL6 A	NSL7 A	NSL8 A	NSL9 A
521-FN1	Bag Filter Fan	32	39	53	41	45	33	27	30	37	28
521-BC1	Conveyor Belt Motor	-9	-7	15	-6	-6	-6	-14	-13	-15	-17
521-BC2	Conveyor Belt Motor	-9	-6	12	-6	-6	-9	-16	-18	-14	-17
521-BE1	Elevator	3	18	28	17	23	7	-3	2	15	2
521-FN2	Bag Filter Fan	24	40	49	39	45	30	22	24	37	23
531-BC1	Conveyor Belt Motor	-9	-6	13	-6	-2	-9	-16	-18	-14	-17
561-FN1	Main Fan	29	32	50	36	35	26	20	21	30	11
561-CH1	Stack	46	51	59	59	58	44	41	40	50	36
591-FN3	Silo Fan	30	31	41	40	41	31	27	26	32	22
591-FN2	Silo Fan	25	35	42	38	37	30	27	25	34	22
591-FN6	Air Slide Fan	27	32	42	38	38	30	27	26	32	22
591-FN5	Air Slide Fan	25	31	42	40	40	30	27	25	32	22
591-BE1	Elevator	8	14	21	21	20	6	2	2	13	-6
591-FN1	Bag Filter Fan	30	38	46	46	44	30	27	26	38	22
612-FA1	Air Slide Fan	24	29	29	36	38	29	26	27	26	24
612-FA2	Air Slide Fan	25	28	36	37	44	28	26	24	34	23
611-FA2	Air Slide Fan	24	27	26	37	37	28	25	24	38	22
612-BE1	Elevator	-7	-4	-2	9	17	-3	-6	-9	4	-19
611-BE1	Elevator	-8	-3	-2	9	11	-4	-6	-4	6	-8
Mill Roof	Emitting Roof	10	15	31	25	25	16	11	9	15	9
Mill Facad	Mill Side	18	21	38	36	37	20	14	14	17	9
Mill Facad	Mill Side	14	22	26	19	19	18	13	10	26	6
	Wheeled loaders (100 kW < > 200 kW)	21	29	43	33	35	21	23	23	43	21
	Hot Gas Building	10	14	34	22	19	7	8	7	15	-2
531-AB1	Air Shock	19	21	50	28	28	20	12	14	17	15
Mill Facad	Mill Side	8	13	29	27	28	12	7	6	17	2
Mill Facad	Mill Side	12	11	19	30	31	15	8	8	24	3
Mill Facad	Mill Side	14	10	17	25	19	18	12	11	27	5
	Hot Gas Building	8	10	28	18	16	12	10	11	20	8
	Hot Gas Building	16	17	28	15	16	12	6	8	9	-1
591-FA3	Air Slide Fan	24	32	48	35	38	29	19	23	30	10
591-FA2	Air Slide Fan	22	32	48	36	38	26	24	21	28	10
591-FA1	Air Slide Fan	19	32	48	38	39	23	21	25	33	22
591-FA4	Air Slide Fan	28	31	49	37	38	22	20	25	27	23
611-FN1	Hopper Fan	25	38	35	39	35	30	25	26	38	16
612-FN1	Hopper Fan	25	36	34	37	37	30	25	24	36	15
611-FA1	Air Slide Fan	23	30	40	36	38	28	25	26	25	24
	Total	47	53	62	60	59	46	42	42	53	38
	(no category)	--	--	--	--	--	--	--	--	--	--
	Exceeding	--	--	--	--	--	--	--	--	--	--

All shown dB values are A-weighted

Report: Table of Control
 Model: Mode 1 Phase 2
 Path: C:\Users\ssmyth.AWNCONSULTING\Documents\Temp Predictor Models\Ecoem\
 Group: (main group)
 Period: Ldn

Name	Description	NSL10 A	NSL1 A	NSL2 A	NSL3 A	NSL4 A	NSL5 A	NSL6 A	NSL7 A	NSL8 A	NSL9 A
521-FN1	Bag Filter Fan	33	39	54	42	46	33	27	31	37	28
521-BC1	Conveyor Belt Motor	-8	-6	16	-5	-5	-5	-14	-12	-14	-16
521-BC2	Conveyor Belt Motor	-8	-5	12	-5	-5	-8	-15	-17	-14	-16
521-BE1	Elevator	3	19	29	18	23	8	-3	3	16	2
521-FN2	Bag Filter Fan	25	40	50	40	45	30	22	25	38	23
531-BC1	Conveyor Belt Motor	-8	-6	14	-6	-1	-8	-15	-17	-14	-16
591-FA4	Air Slide Fan	24	28	37	36	38	29	21	25	30	22
561-FN1	Main Fan	30	33	51	36	35	27	21	21	29	12
561-CH1	Stack	46	51	59	59	58	44	41	40	50	36
591-FN3	Silo Fan	31	31	38	40	42	31	28	26	32	23
591-FN2	Silo Fan	26	35	43	38	37	31	27	26	34	22
591-FN6	Air Slide Fan	27	33	39	39	39	31	28	27	33	23
591-FN5	Air Slide Fan	26	32	42	38	37	31	27	26	32	22
591-BE1	Elevator	8	14	22	22	20	6	3	3	14	-5
591-FN1	Bag Filter Fan	31	39	45	40	45	31	27	27	38	22
612-FA1	Air Slide Fan	25	29	29	37	39	30	27	27	27	25
612-FA2	Air Slide Fan	25	28	36	38	45	29	26	25	34	23
611-FA2	Air Slide Fan	25	28	26	38	38	28	26	25	39	22
612-BE1	Elevator	-6	-3	-1	10	17	-2	-5	-9	4	-19
611-BE1	Elevator	-7	-3	-2	10	12	-3	-6	-3	6	-8
Mill Roof	Emitting Roof	11	16	31	25	25	16	11	10	16	10
Mill Facad	Mill Side	19	22	39	36	38	21	14	15	17	10
Mill Facad	Mill Side	14	23	27	20	19	19	13	10	27	7
	Wheeled loaders (100 kW < > 200 kW)	22	30	43	33	35	22	24	24	44	22
	Hot Gas Building	11	15	34	23	20	8	9	7	15	-1
531-AB1	Air Shock	19	21	51	29	29	21	12	14	18	15
Mill Facad	Mill Side	8	14	30	28	28	12	8	7	18	2
Mill Facad	Mill Side	12	11	19	30	32	16	8	9	25	4
Mill Facad	Mill Side	15	11	18	25	20	18	12	12	28	6
	Hot Gas Building	9	11	28	19	19	13	11	12	21	9
	Hot Gas Building	16	18	28	16	17	13	7	9	10	0
591-FA3	Air Slide Fan	25	33	49	36	39	29	20	24	31	11
591-FA2	Air Slide Fan	22	33	49	36	38	26	25	22	29	11
591-FA1	Air Slide Fan	20	33	49	38	39	24	22	25	34	22
591-FA4	Air Slide Fan	29	33	38	38	38	23	21	26	27	23
611-FN1	Hopper Fan	26	39	36	40	35	31	26	27	39	17
612-FN1	Hopper Fan	25	37	35	38	38	31	26	25	37	16
611-FA1	Air Slide Fan	24	31	41	36	39	28	26	27	26	25
591-FN3	Silo Fan	27	35	45	39	39	31	27	27	31	22
591-FN7	Air Slide Fan	31	32	43	41	42	31	27	26	31	22
Total		47	53	62	60	59	47	43	43	53	39
	(no category)	--	--	--	--	--	--	--	--	--	--
	Exceeding	--	--	--	--	--	--	--	--	--	--

All shown dB values are A-weighted

Report: Table of Control
 Model: Mode 2 Phase 1
 Path: C:\Users\ssmyth.AWNCONSULTING\Documents\Temp Predictor Models\Ecocem\
 Group: (main group)
 Period: Ldn

Name	Description	NSL10 A	NSL1 A	NSL2 A	NSL3 A	NSL4 A	NSL5 A	NSL6 A	NSL7 A	NSL8 A	NSL9 A
521-FN1	Bag Filter Fan	34	39	60	45	48	37	28	32	28	29
521-BC1	Conveyor Belt Motor	-8	-7	18	1	2	-4	-12	-11	-15	-14
521-BC2	Conveyor Belt Motor	-8	-6	15	2	3	-8	-13	-11	-14	-14
521-BE1	Elevator	3	18	28	17	23	7	-3	2	12	2
521-FN2	Bag Filter Fan	24	40	49	39	45	30	22	24	33	23
531-BC1	Conveyor Belt Motor	-9	-6	14	2	3	-5	-13	-11	-13	-14
591-FA4	Air Slide Fan	24	29	42	35	37	30	22	25	29	22
561-FN1	Main Fan	29	32	50	36	35	26	20	21	30	11
561-CH1	Stack	46	51	59	59	58	44	41	40	50	36
591-FN3	Silo Fan	30	30	41	40	41	31	27	26	32	22
591-FN2	Silo Fan	25	35	42	38	37	30	27	25	34	22
591-FN6	Air Slide Fan	27	32	42	38	38	30	27	26	32	22
591-FN5	Air Slide Fan	25	31	42	40	40	30	27	25	32	22
591-BE1	Elevator	8	14	21	21	20	6	2	2	13	-6
591-FN1	Bag Filter Fan	30	38	46	46	44	30	27	26	38	22
612-FA1	Air Slide Fan	24	22	39	36	38	29	26	27	26	24
612-FA2	Air Slide Fan	25	28	36	37	44	28	26	24	34	23
611-FA2	Air Slide Fan	24	27	40	37	37	28	25	24	38	22
612-BE1	Elevator	-7	-4	18	9	17	-3	-6	-9	4	-19
611-BE1	Elevator	-8	-3	18	9	11	-4	-6	-4	6	-8
513-FN1	Clinker Store Bag Filter Fan	36	48	61	46	50	38	35	39	39	37
Mill Roof	Emitting Roof	10	15	31	25	25	16	11	9	15	9
Mill Facad	Mill Side	18	21	38	36	37	20	14	14	17	9
Mill Facad	Mill Side	14	22	26	19	19	18	13	10	26	6
	Wheeled loaders (100 kW < > 200 kW)	27	32	43	36	38	26	24	25	43	22
	Clinker Bld Fan	14	23	39	24	26	14	12	11	9	13
	Clinker Bld Fan	12	27	40	16	19	13	15	17	14	13
	Clinker Bld Fan	9	28	39	21	19	13	16	15	18	11
	Clinker Bld Fan	4	29	39	15	14	8	8	9	28	6
	Clinker Bld Fan	24	21	38	28	33	20	12	14	26	7
	Clinker Bld Fan	20	18	38	29	34	23	13	17	27	7
	Clinker Bld Fan	18	22	38	27	32	21	21	17	30	9
	Clinker Bld Fan	14	18	19	29	32	23	16	18	35	10
	Hot Gas Building	10	14	34	22	19	8	8	7	15	-2
531-AB1	Air Shock	19	21	50	34	32	23	14	15	14	15
Mill Facad	Mill Side	8	13	29	27	28	12	7	6	17	2
Mill Facad	Mill Side	12	11	18	30	31	15	8	8	24	3
Mill Facad	Mill Side	14	10	17	25	19	18	12	11	27	5
	Hot Gas Building	8	15	28	18	16	12	10	11	20	8
	Hot Gas Building	16	17	28	15	16	12	6	8	9	-1
591-FA3	Air Slide Fan	24	32	48	35	38	29	19	23	30	10
591-FA2	Air Slide Fan	22	32	48	36	38	26	24	21	28	10
591-FA1	Air Slide Fan	19	32	48	38	39	23	21	25	33	22
591-FA4	Air Slide Fan	28	29	48	37	38	22	21	25	27	23
611-FN1	Hopper Fan	25	33	35	39	35	30	25	26	38	16
612-FN1	Hopper Fan	25	31	34	37	37	30	25	24	36	15
611-FA1	Air Slide Fan	23	21	39	36	38	28	25	26	25	24
	Total	47	54	66	60	60	47	43	44	53	41
	(no category)	--	--	--	--	--	--	--	--	--	--
	Exceeding	--	--	--	--	--	--	--	--	--	--

All shown dB values are A-weighted

Report: Table of Control
 Model: Mode 2 Phase 2
 Path: C:\Users\ssmyth.AWNCONSULTING\Documents\Temp Predictor Models\Ecoem\
 Group: (main group)
 Period: Ldn

Name	Description	NSL10 A	NSL1 A	NSL2 A	NSL3 A	NSL4 A	NSL5 A	NSL6 A	NSL7 A	NSL8 A	NSL9 A
521-FN1	Bag Filter Fan	35	39	60	45	49	37	29	33	28	29
521-BC1	Conveyor Belt Motor	-7	-6	19	2	3	-4	-12	-10	-14	-13
521-BC2	Conveyor Belt Motor	-8	-5	16	3	3	-7	-12	-11	-13	-13
521-BE1	Elevator	3	19	29	18	23	8	-3	3	12	2
521-FN2	Bag Filter Fan	25	40	50	40	45	30	22	25	34	23
531-BC1	Conveyor Belt Motor	-8	-6	17	3	3	-4	-12	-11	-13	-13
591-FA4	Air Slide Fan	24	28	40	36	38	29	21	25	30	22
561-FN1	Main Fan	30	33	51	36	35	27	21	21	29	12
561-CH1	Stack	46	51	59	59	58	44	41	40	50	36
591-FN3	Silo Fan	31	31	38	40	42	31	28	26	32	23
591-FN2	Silo Fan	26	35	43	38	37	31	27	26	34	22
591-FN6	Air Slide Fan	27	33	39	39	39	31	28	27	33	23
591-FN5	Air Slide Fan	26	31	42	38	37	31	27	26	32	22
591-BE1	Elevator	8	14	22	15	20	6	3	3	14	-5
591-FN1	Bag Filter Fan	31	39	45	46	45	31	27	27	38	22
612-FA1	Air Slide Fan	25	22	40	37	39	30	27	27	27	25
612-FA2	Air Slide Fan	25	28	36	38	45	29	26	25	34	23
611-FA2	Air Slide Fan	25	28	41	38	38	28	26	25	39	22
612-BE1	Elevator	-6	-3	19	10	17	-2	-5	-9	4	-19
611-BE1	Elevator	-7	-3	18	10	12	-3	-6	-3	6	-8
513-FN1	Clinker Store Bag Filter Fan	36	48	61	46	50	38	35	39	39	37
Mill Roof	Emitting Roof	11	16	31	25	25	16	11	10	16	10
Mill Facad	Mill Side	19	22	39	36	38	21	14	15	17	10
Mill Facad	Mill Side	14	23	27	20	19	19	13	10	27	7
	Wheeled loaders (100 kW < > 200 kW)	27	33	43	37	38	26	24	26	44	23
	Clinker Bld Fan	14	23	39	24	26	14	12	11	9	13
	Clinker Bld Fan	12	27	40	16	19	13	15	17	14	13
	Clinker Bld Fan	9	28	39	20	19	13	16	15	17	11
	Clinker Bld Fan	4	29	39	15	14	8	8	9	28	6
	Clinker Bld Fan	24	21	38	28	33	20	11	14	25	7
	Clinker Bld Fan	20	18	38	29	34	23	13	17	27	7
	Clinker Bld Fan	17	16	38	27	32	23	21	16	30	9
	Clinker Bld Fan	14	18	19	29	32	23	16	21	35	11
	Hot Gas Building	11	14	34	23	20	8	9	7	15	-1
531-AB1	Air Shock	19	21	51	35	32	24	15	15	14	16
Mill Facad	Mill Side	8	14	30	28	28	12	8	7	18	2
Mill Facad	Mill Side	12	11	19	30	32	16	8	9	25	4
Mill Facad	Mill Side	15	11	18	25	20	18	12	12	28	6
	Hot Gas Building	9	16	29	19	19	13	11	12	21	9
	Hot Gas Building	16	18	29	16	17	13	7	9	10	0
591-FA3	Air Slide Fan	25	33	49	36	39	29	20	24	31	11
591-FA2	Air Slide Fan	22	33	49	36	38	26	25	22	29	11
591-FA1	Air Slide Fan	20	33	49	38	39	24	22	25	34	22
591-FA4	Air Slide Fan	29	29	38	38	38	23	21	26	27	23
611-FN1	Hopper Fan	26	33	36	40	35	31	26	27	39	17
612-FN1	Hopper Fan	25	32	35	38	38	31	26	25	37	16
611-FA1	Air Slide Fan	24	22	40	36	39	29	26	27	26	25
591-FN3	Silo Fan	27	35	45	39	39	31	27	27	31	22
591-FN7	Air Slide Fan	31	31	43	41	42	31	27	26	31	22
	Total	48	54	66	60	60	47	44	45	53	41
	(no category)	--	--	--	--	--	--	--	--	--	--
	Exceeding	--	--	--	--	--	--	--	--	--	--

All shown dB values are A-weighted

APPENDIX J
Truck Noise Model Results

Report: Table of Control
 Model: Mode Milestone 1.4
 Path: C:\Users\ssmyth.AWNCONSULTING\Documents\Temp Predictor Models\Ecocem\
 Group: (main group)
 Period: Ldn

Name	Description	NSL10 A	NSL1 A	NSL2 A	NSL3 A	NSL4 A	NSL5 A	NSL6 A	NSL7 A	NSL8 A	NSL9 A
R1	Lemon St Uphill	--	49	--	35	36	46	57	34	49	37
	Lemon Street Down Hill	--	49	--	--	--	--	--	24	49	55
	Lemon Street Down Hill	--	49	40	35	37	47	60	42	49	50
R1	Lemon St Uphill	--	49	--	--	--	--	--	34	49	57
R2	Sonoma Blvd N (Right) (Right)	--	49	--	--	--	--	--	--	49	--
R2	Sonoma Blvd N (Right) (Left)	--	49	--	--	--	--	--	--	49	--
	(Right)	--	49	--	--	--	--	--	--	49	--
	(Left)	--	49	--	--	--	--	--	--	49	--
R2	Sonoma Blvd N (route 2)	--	49	--	--	--	--	--	46	49	38
R2	Sonoma Blvd N (Right) (Left)	--	49	--	--	--	--	--	--	49	--
	Sonoma Blvd (Route 2)	--	49	--	--	--	--	--	57	49	24
	(Left)	--	49	--	--	--	--	--	--	49	--
R6	I80W (Left)	--	49	--	--	--	--	--	--	49	--
	(Left)	--	49	--	--	--	--	--	--	49	--
	(Left)	--	49	--	--	--	--	--	--	49	--
	(Left) (Left)	--	49	--	--	--	--	--	--	49	--
R6	I80W (Left) (Right)	--	49	--	--	--	--	--	--	49	--
R6	I80W (Left) (Left)	--	49	--	--	--	--	--	--	49	--
	Total	--	62	40	38	39	50	62	57	62	60
	(no category)	--	--	--	--	--	--	--	--	--	--
	Exceeding	--	--	--	--	--	--	--	--	--	--

All shown dB values are A-weighted

Report: Table of Control
 Model: Mode Milestone 1.5
 Path: C:\Users\ssmyth.AWNCONSULTING\Documents\Temp Predictor Models\Ecocem\
 Group: (main group)
 Period: Ldn

Name	Description	NSL10 A	NSL1 A	NSL2 A	NSL3 A	NSL4 A	NSL5 A	NSL6 A	NSL7 A	NSL8 A	NSL9 A
R1	Lemon St Uphill	--	49	--	36	37	48	59	35	49	38
	Lemon Street Down Hill	--	49	--	--	--	--	--	25	49	56
	Lemon Street Down Hill	--	49	42	36	38	49	62	44	49	51
R1	Lemon St Uphill	--	49	--	--	--	--	--	36	49	59
R2	Sonoma Blvd N (Right) (Right)	--	49	--	--	--	--	--	--	49	--
R2	Sonoma Blvd N (Right) (Left)	--	49	--	--	--	--	--	--	49	--
	(Right)	--	49	--	--	--	--	--	--	49	--
	(Left)	--	49	--	--	--	--	--	--	49	--
R2	Sonoma Blvd N (route 2)	--	49	--	--	--	--	--	48	49	40
R2	Sonoma Blvd N (Right) (Left)	--	49	--	--	--	--	--	--	49	--
	Sonoma Blvd (Route 2)	--	49	--	--	--	--	--	59	49	26
	(Left)	--	49	--	--	--	--	--	--	49	--
R6	I80W (Left)	--	49	--	--	--	--	--	--	49	--
	(Left)	--	49	--	--	--	--	--	--	49	--
	(Left)	--	49	--	--	--	--	--	--	49	--
	(Left) (Left)	--	49	--	--	--	--	--	--	49	--
R6	I80W (Left) (Right)	--	49	--	--	--	--	--	--	49	--
R6	I80W (Left) (Left)	--	49	--	--	--	--	--	--	49	--
	Total	--	62	42	39	41	51	64	59	62	61
	(no category)	--	--	--	--	--	--	--	--	--	--
	Exceeding	--	--	--	--	--	--	--	--	--	--

All shown dB values are A-weighted

Report: Table of Control
 Model: Mode Milestone 2.4
 Path: C:\Users\ssmyth.AWNCONSULTING\Documents\Temp Predictor Models\Ecocem\
 Group: (main group)
 Period: Ldn

Name	Description	NSL10 A	NSL1 A	NSL2 A	NSL3 A	NSL4 A	NSL5 A	NSL6 A	NSL7 A	NSL8 A	NSL9 A
R1	Lemon St Uphill	--	49	--	36	37	48	59	35	49	38
	Lemon Street Down Hill	--	49	--	--	--	--	--	25	49	56
	Lemon Street Down Hill	--	49	42	36	38	49	62	44	49	51
R1	Lemon St Uphill	--	49	--	--	--	--	--	36	49	59
R2	Sonoma Blvd N (Right) (Right)	--	49	--	--	--	--	--	--	49	--
R2	Sonoma Blvd N (Right) (Left)	--	49	--	--	--	--	--	--	49	--
	(Right)	--	49	--	--	--	--	--	--	49	--
	(Left)	--	49	--	--	--	--	--	--	49	--
R2	Sonoma Blvd N (route 2)	--	49	--	--	--	--	--	48	49	40
R2	Sonoma Blvd N (Right) (Left)	--	49	--	--	--	--	--	--	49	--
	Sonoma Blvd (Route 2)	--	49	--	--	--	--	--	59	49	26
	(Left)	--	49	--	--	--	--	--	--	49	--
R6	I80W (Left)	--	49	--	--	--	--	--	--	49	--
	(Left)	--	49	--	--	--	--	--	--	49	--
	(Left) (Left)	--	49	--	--	--	--	--	--	49	--
R6	I80W (Left) (Right)	--	49	--	--	--	--	--	--	49	--
R6	I80W (Left) (Left)	--	49	--	--	--	--	--	--	49	--
	Total	--	62	42	39	41	51	64	59	62	61
	(no category)	--	--	--	--	--	--	--	--	--	--
	Exceeding	--	--	--	--	--	--	--	--	--	--

All shown dB values are A-weighted

Report: Table of Control
 Model: Mode Milestone 2.5
 Path: C:\Users\ssmyth.AWNCONSULTING\Documents\Temp Predictor Models\Ecocem\
 Group: (main group)
 Period: Ldn

Name	Description	NSL10 A	NSL1 A	NSL2 A	NSL3 A	NSL4 A	NSL5 A	NSL6 A	NSL7 A	NSL8 A	NSL9 A
R1	Lemon St Uphill	--	49	--	38	39	50	61	37	49	40
	Lemon Street Down Hill	--	49	--	--	--	--	--	27	49	58
	Lemon Street Down Hill	--	49	44	38	40	51	64	46	49	53
R1	Lemon St Uphill	--	49	--	--	--	--	--	37	49	60
R2	Sonoma Blvd N (Right) (Right)	--	49	--	--	--	--	--	--	49	--
R2	Sonoma Blvd N (Right) (Left)	--	49	--	--	--	--	--	--	49	--
	(Right)	--	49	--	--	--	--	--	--	49	--
	(Left)	--	49	--	--	--	--	--	--	49	--
R2	Sonoma Blvd N (route 2)	--	49	--	--	--	--	--	51	49	42
R2	Sonoma Blvd N (Right) (Left)	--	49	--	--	--	--	--	--	49	--
	Sonoma Blvd (Route 2)	--	49	--	--	--	--	--	61	49	28
	(Left)	--	49	--	--	--	--	--	--	49	--
R6	I80W (Left)	--	49	--	--	--	--	--	--	49	--
	(Left)	--	49	--	--	--	--	--	--	49	--
	(Left)	--	49	--	--	--	--	--	--	49	--
	(Left) (Left)	--	49	--	--	--	--	--	--	49	--
R6	I80W (Left) (Right)	--	49	--	--	--	--	--	--	49	--
R6	I80W (Left) (Left)	--	49	--	--	--	--	--	--	49	--
	Total	--	62	44	41	43	53	66	61	62	63
	(no category)	--	--	--	--	--	--	--	--	--	--
	Exceeding	--	--	--	--	--	--	--	--	--	--

All shown dB values are A-weighted

Report: Table of Control
 Model: Mode Milestone 3.4
 Path: C:\Users\ssmyth.AWNCONSULTING\Documents\Temp Predictor Models\Ecocem\
 Group: (main group)
 Period: Ldn

Name	Description	NSL10 A	NSL1 A	NSL2 A	NSL3 A	NSL4 A	NSL5 A	NSL6 A	NSL7 A	NSL8 A	NSL9 A
R1	Lemon St Uphill	--	49	--	35	36	46	57	34	49	37
	Lemon Street Down Hill	--	49	--	--	--	--	--	24	49	55
	Lemon Street Down Hill	--	49	41	35	37	48	60	42	49	50
R1	Lemon St Uphill	--	49	--	--	--	--	--	34	49	57
R2	Sonoma Blvd N (Right) (Right)	--	49	--	--	--	--	--	--	49	--
R2	Sonoma Blvd N (Right) (Left)	--	49	--	--	--	--	--	--	49	--
	(Right)	--	49	--	--	--	--	--	--	49	--
	(Left)	--	49	--	--	--	--	--	--	49	--
R2	Sonoma Blvd N (route 2)	--	49	--	--	--	--	--	47	49	38
R2	Sonoma Blvd N (Right) (Left)	--	49	--	--	--	--	--	--	49	--
	Sonoma Blvd (Route 2)	--	49	--	--	--	--	--	57	49	24
	(Left)	--	49	--	--	--	--	--	--	49	--
R6	I80W (Left)	--	49	--	--	--	--	--	--	49	--
	(Left)	--	49	--	--	--	--	--	--	49	--
	(Left)	--	49	--	--	--	--	--	--	49	--
	(Left) (Left)	--	49	--	--	--	--	--	--	49	--
R6	I80W (Left) (Right)	--	49	--	--	--	--	--	--	49	--
R6	I80W (Left) (Left)	--	49	--	--	--	--	--	--	49	--
	Total	--	62	41	38	40	50	62	58	62	60
	(no category)	--	--	--	--	--	--	--	--	--	--
	Exceeding	--	--	--	--	--	--	--	--	--	--

All shown dB values are A-weighted

Report: Table of Control
 Model: Mode Milestone 3.5
 Path: C:\Users\ssmyth.AWNCONSULTING\Documents\Temp Predictor Models\Ecocem\
 Group: (main group)
 Period: Ldn

Name	Description	NSL10 A	NSL1 A	NSL2 A	NSL3 A	NSL4 A	NSL5 A	NSL6 A	NSL7 A	NSL8 A	NSL9 A
R1	Lemon St Uphill	--	49	--	37	38	48	59	36	49	39
	Lemon Street Down Hill	--	49	--	--	--	--	--	25	49	56
	Lemon Street Down Hill	--	49	43	37	39	50	62	44	49	52
R1	Lemon St Uphill	--	49	--	--	--	--	--	36	49	59
R2	Sonoma Blvd N (Right) (Right)	--	49	--	--	--	--	--	--	49	--
R2	Sonoma Blvd N (Right) (Left)	--	49	--	--	--	--	--	--	49	--
	(Right)	--	49	--	--	--	--	--	--	49	--
	(Left)	--	49	--	--	--	--	--	--	49	--
R2	Sonoma Blvd N (route 2)	--	49	--	--	--	--	--	50	49	41
R2	Sonoma Blvd N (Right) (Left)	--	49	--	--	--	--	--	--	49	--
	Sonoma Blvd (Route 2)	--	49	--	--	--	--	--	60	49	27
	(Left)	--	49	--	--	--	--	--	--	49	--
R6	I80W (Left)	--	49	--	--	--	--	--	--	49	--
	(Left)	--	49	--	--	--	--	--	--	49	--
	(Left)	--	49	--	--	--	--	--	--	49	--
	(Left) (Left)	--	49	--	--	--	--	--	--	49	--
R6	I80W (Left) (Right)	--	49	--	--	--	--	--	--	49	--
R6	I80W (Left) (Left)	--	49	--	--	--	--	--	--	49	--
	Total	--	62	43	40	42	52	64	60	62	61
	(no category)	--	--	--	--	--	--	--	--	--	--
	Exceeding	--	--	--	--	--	--	--	--	--	--

All shown dB values are A-weighted

